

600 Larder and Appliance Unit Assembly

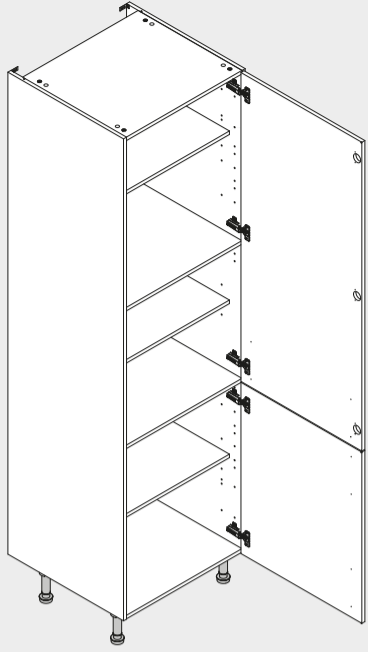

Larder Unit

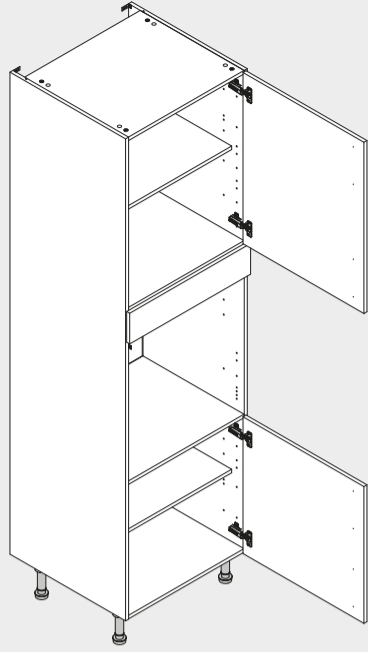

Single Oven Appliance Unit

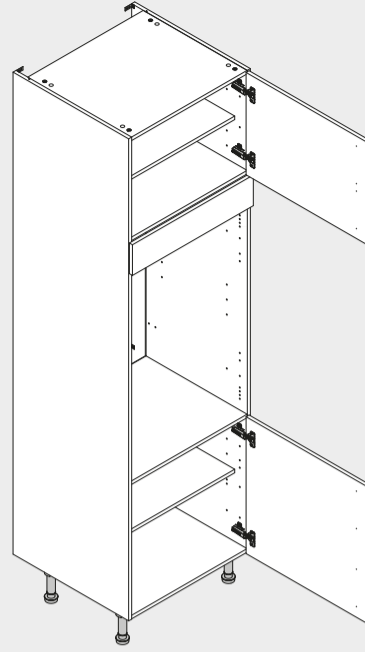

Double Oven Appliance Unit

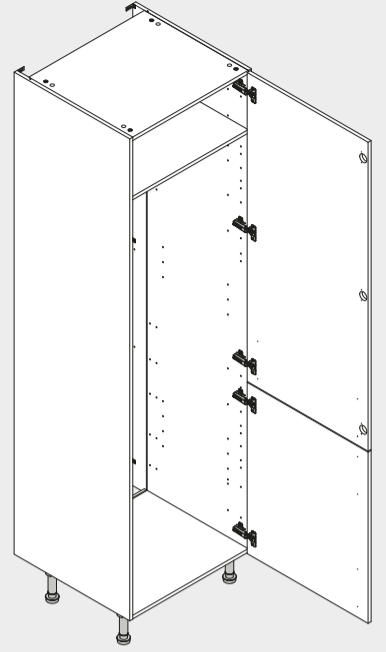

Fridge Freezer Appliance Unit

Important Information

Caution: Some pieces of hardware could be hazardous to small children. Keep all these items out of reach and do not leave children unattended in the assembly area.

Please read these instructions carefully before proceeding. Some of the units are quite large and may have to be assembled in the room where they are to be installed.

Note: Due to variation in wall conditions no screws are supplied for fixing the units to the wall. If in doubt consult an expert. Assemble the unit on a clean solid work surface. Screws for joining cabinets together are not supplied.

In the interest of continuing improvements we reserve the right to amend or adjust the specifications without prior notice. Errors and omissions excepted.

These units have been designed to give you years of pleasure and satisfaction. You can help to maintain the original beauty of your kitchen by following these guidelines.

Cleaning: Any spillage, even water, should be removed from the surface immediately. Remove any marks with a soft damp cloth and mild household detergent. Wipe over with a damp cloth to remove any excess moisture and dry with a soft, clean cloth. Do not use solvents, abrasive cleaners or pigmented glass cleaners.

Helpful Information

Every effort has been made to ensure that this product leaves the factory in perfect condition. In the unlikely event that an item is damaged or incorrect, please follow these instructions:

Replacement fascias/doors: Please call **01132 013495** between 8am and 5pm, Monday to Friday. Please have your batch number and product code ready to quote from the side of the box in order to request a replacement. On receipt of all the required information this will be despatched directly to your home within five working days.

Replacement, damaged or incorrect fittings or cabinet parts: Please contact the store where the item was purchased for replacements.

Ref. No.	Item	Quantity	Ref. No.	Item	Quantity	Ref. No.	Item	Quantity
150101	3.5x13mm	24	154014	Bracket	2	152401	Knob	4
150202	4.5x13mm	12	154015	Bracket	2	152400	Knob	4
150201	4.5x17mm	6	152104	Bracket	5	152402	Bracket	3
150124	4x25mm	8	152112	Bracket	5	151701	Knob	6
154084	Screw	16	<h3>Tools Required</h3> Drill G-Clamp (pair) Spirit Level Bradawl Medium Crosshead Screwdriver Hammer Large Flathead Screwdriver Tape Measure Saw					
154085	Bracket	16						
154004	Bracket	16						
154024	Bracket	12						
154068	Bracket	6						
151999	Knob	6						

Components

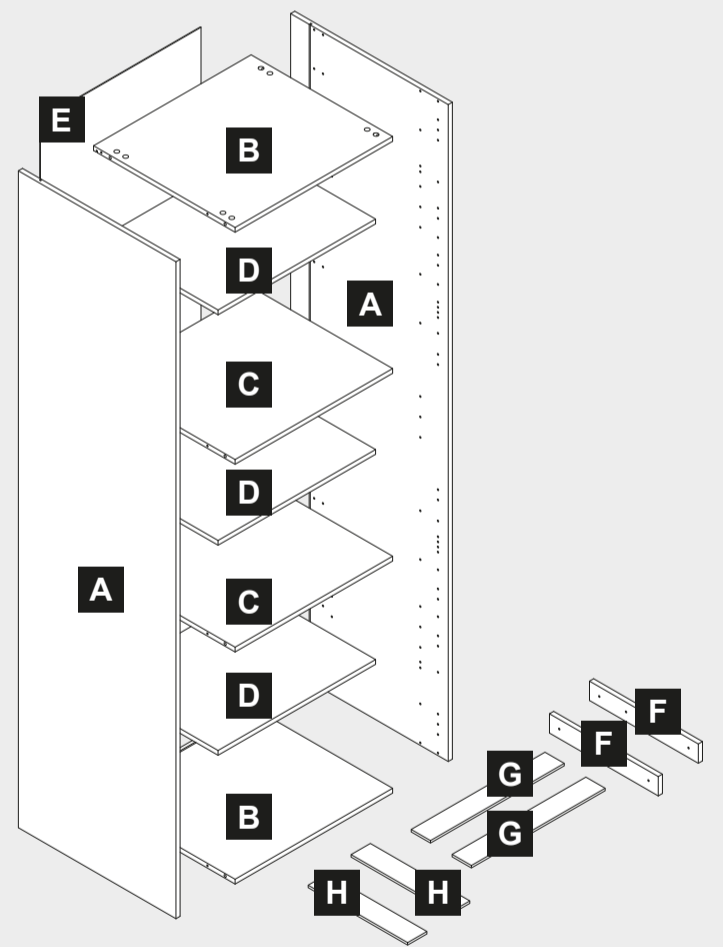

1 Assembly Instructions

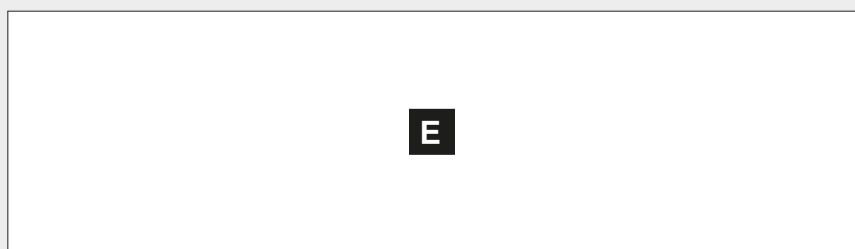

Larder Unit

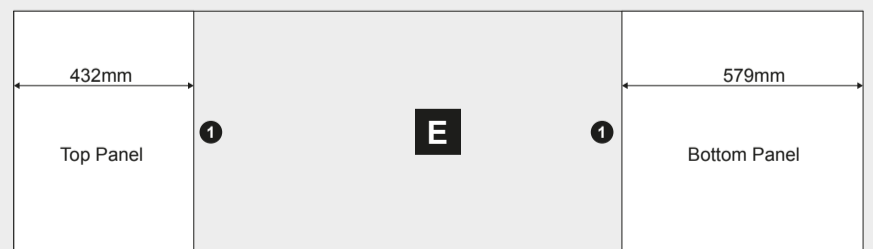

Double Oven Appliance Unit

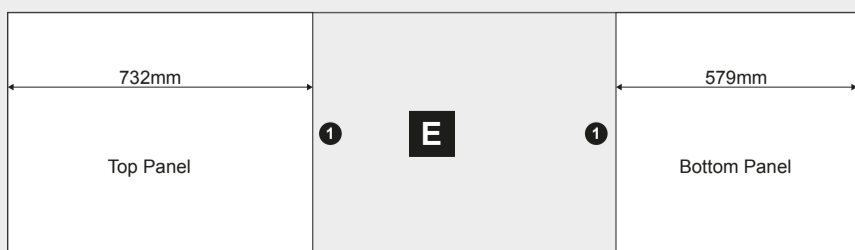

Single Oven Appliance Unit

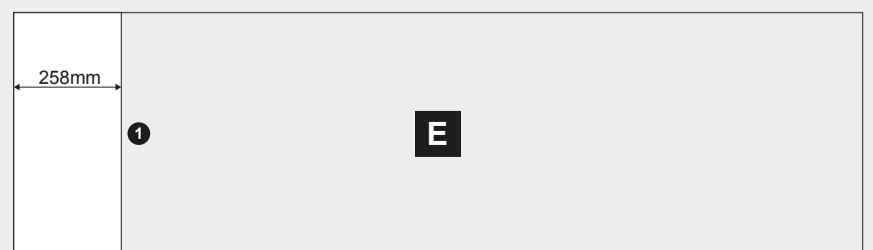

Fridge Freezer Appliance Unit

2 3

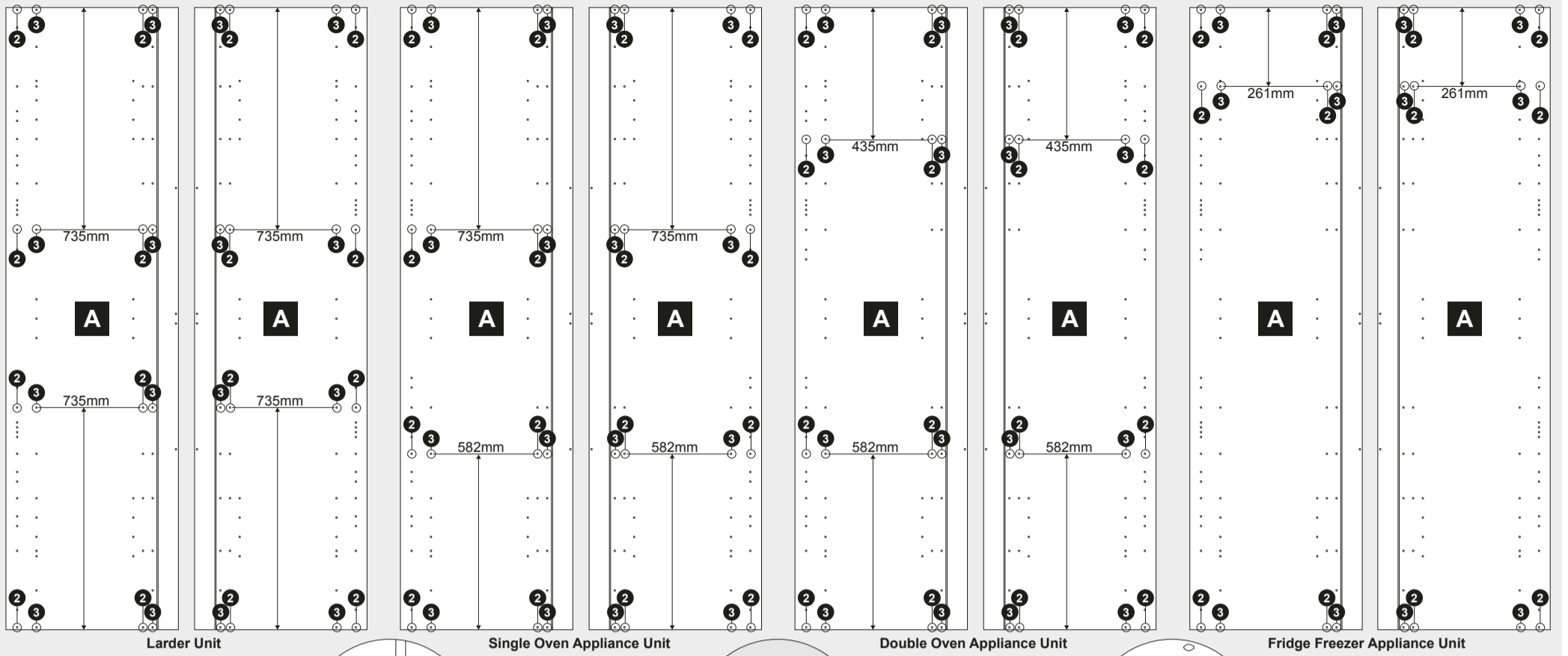

Larder Unit

Single Oven Appliance Unit

Double Oven Appliance Unit

Fridge Freezer Appliance Unit

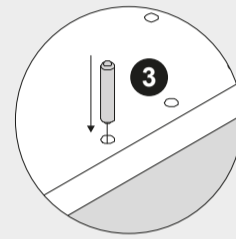
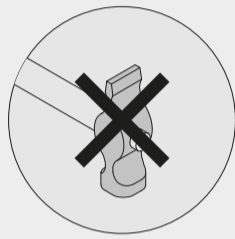
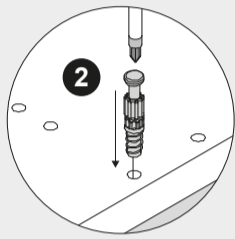
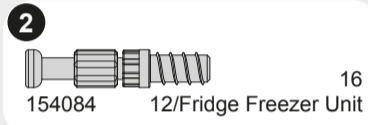

4

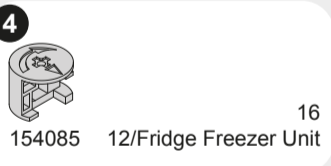
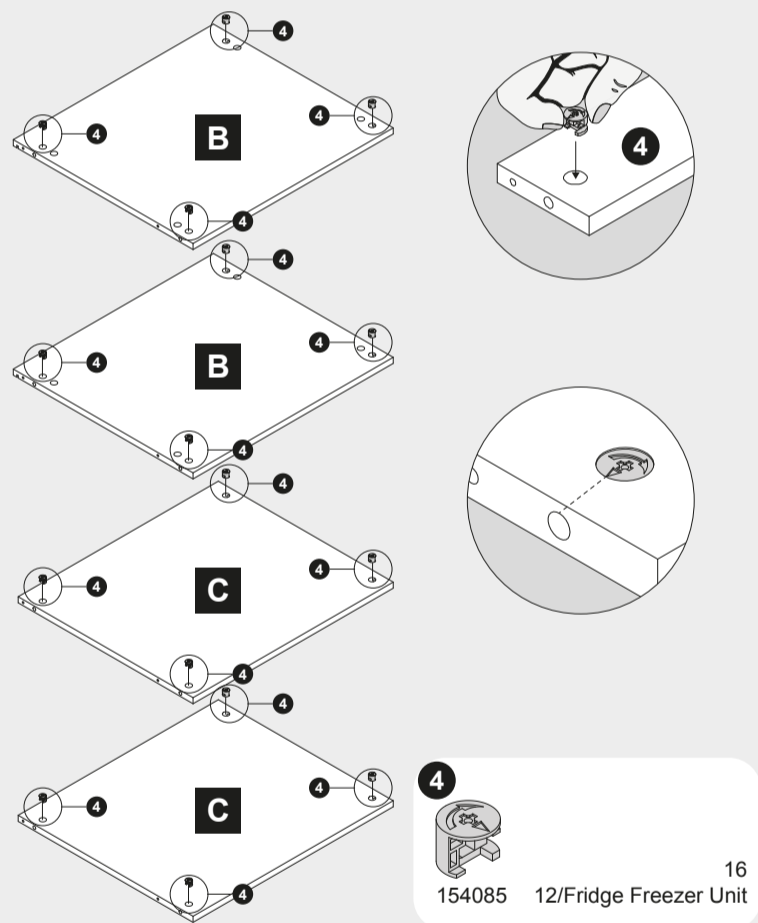

5 6

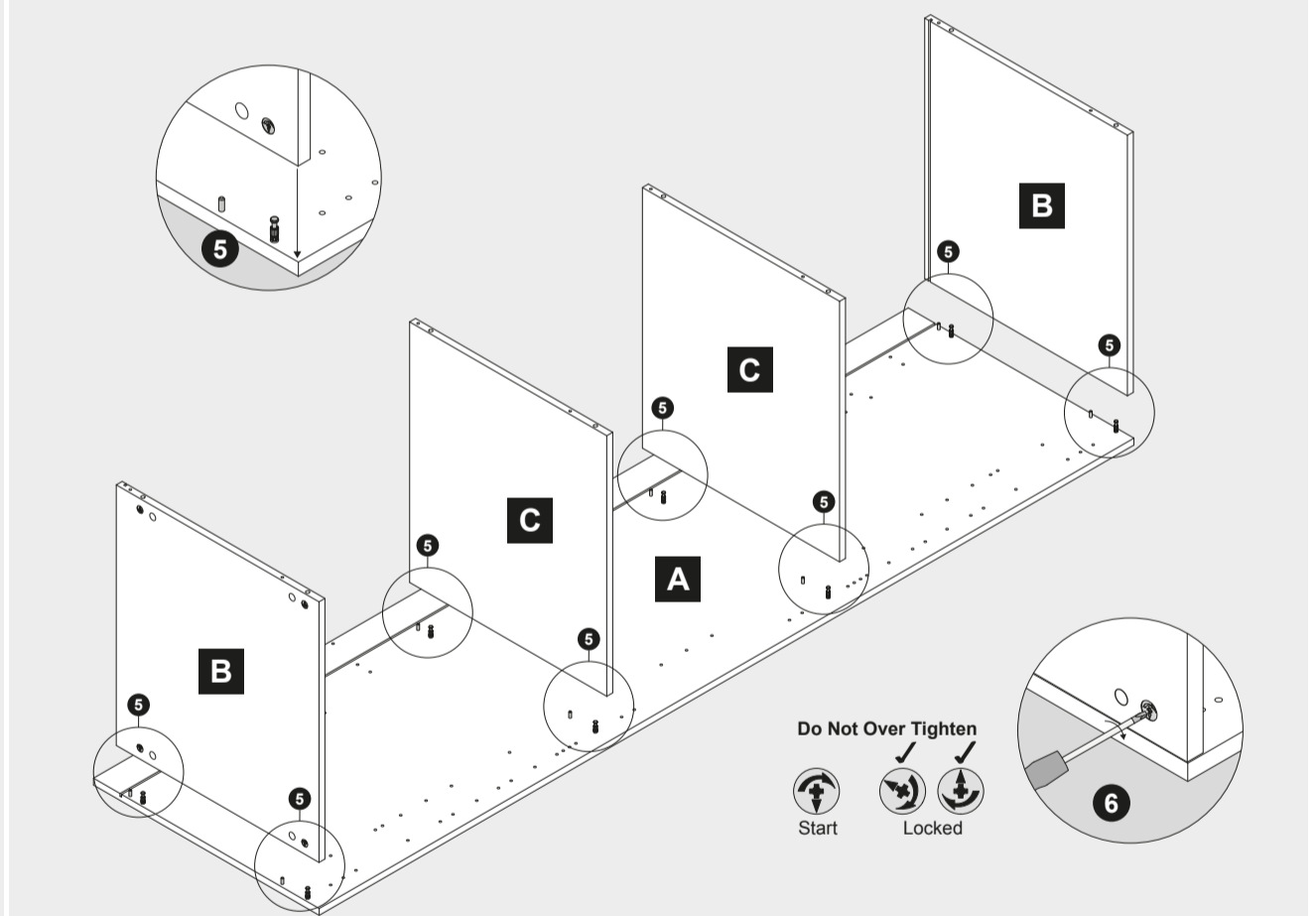

7

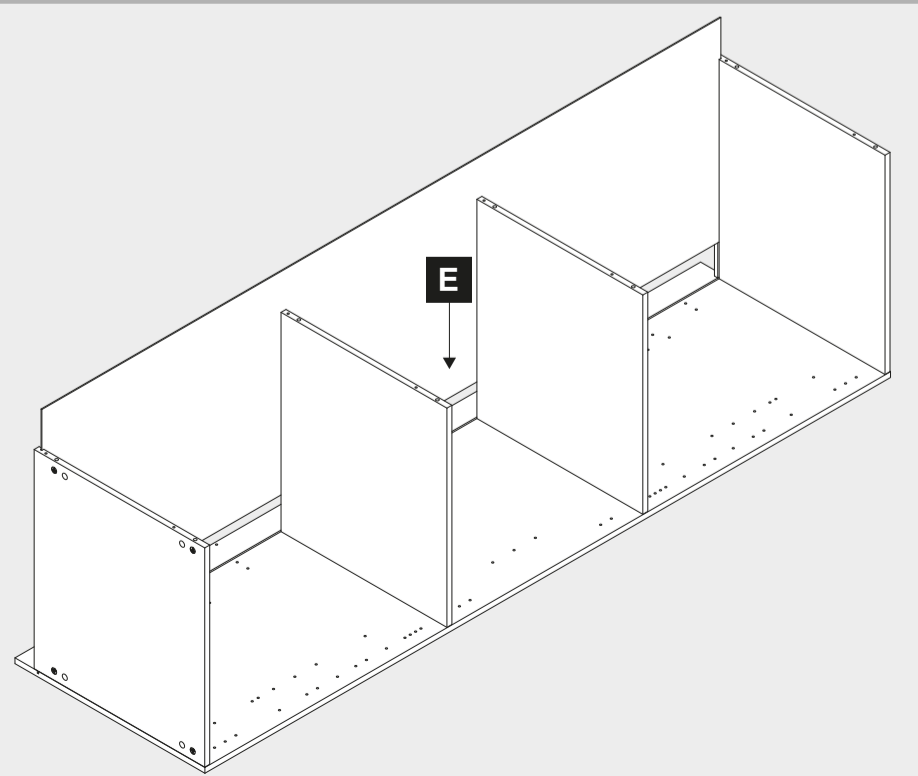

8

Note: Appliance Units only.

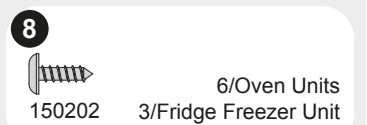
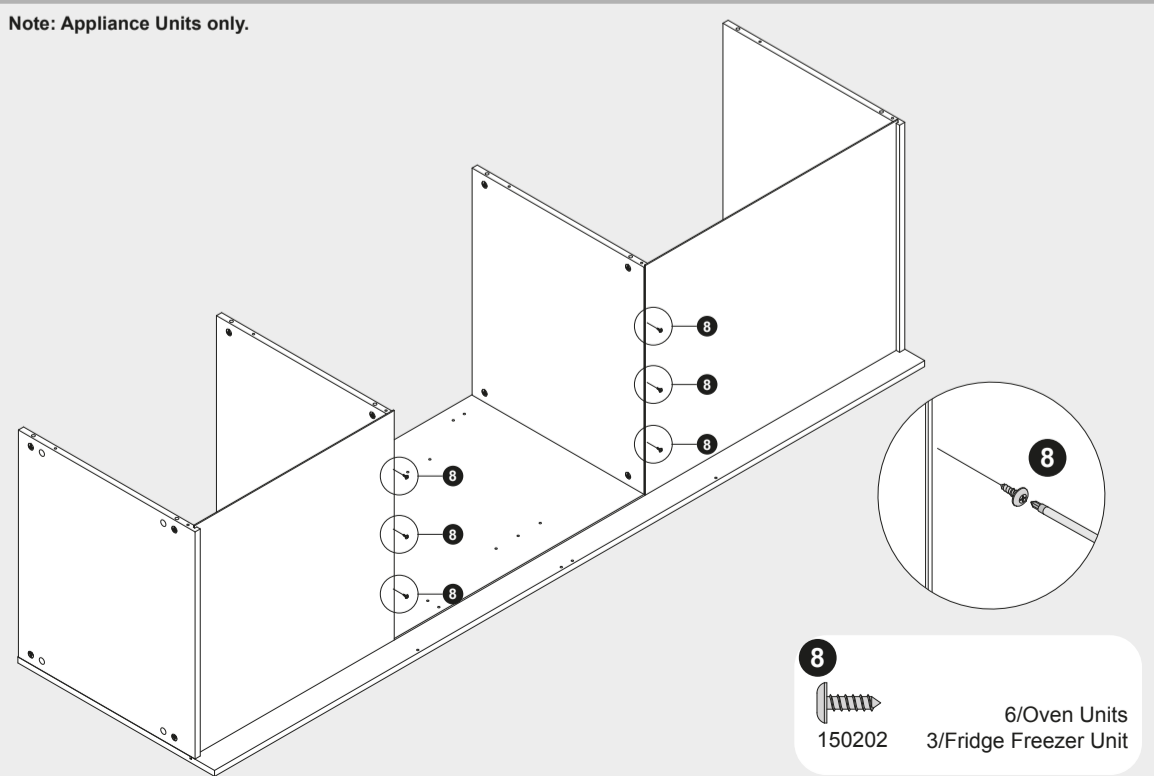

9 — 10

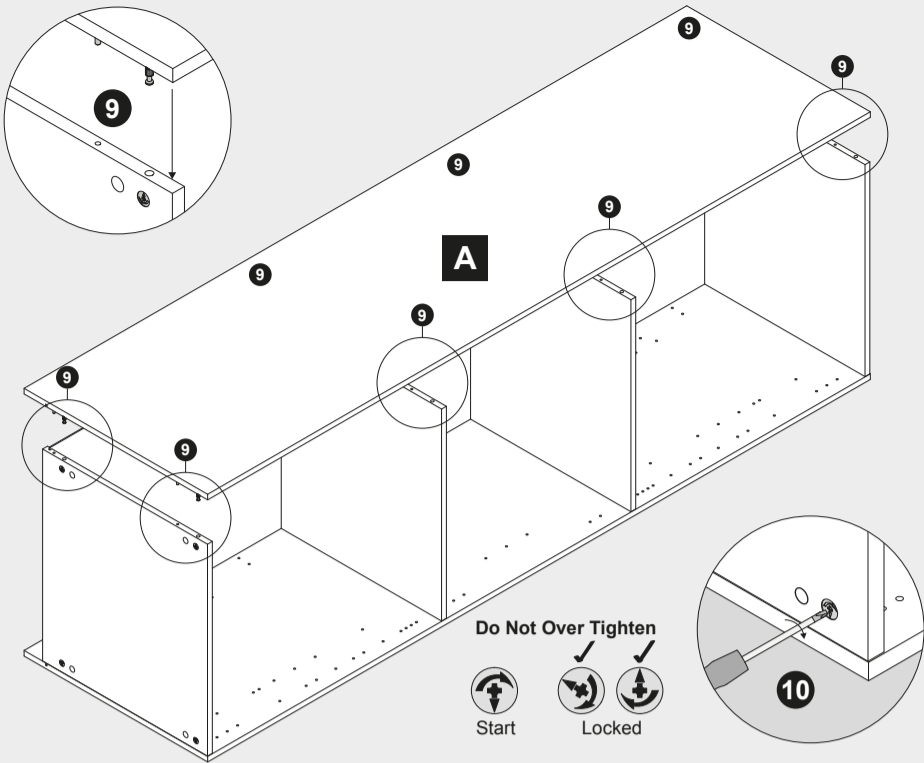

Do Not Over Tighten
Start Locked

11 — 12

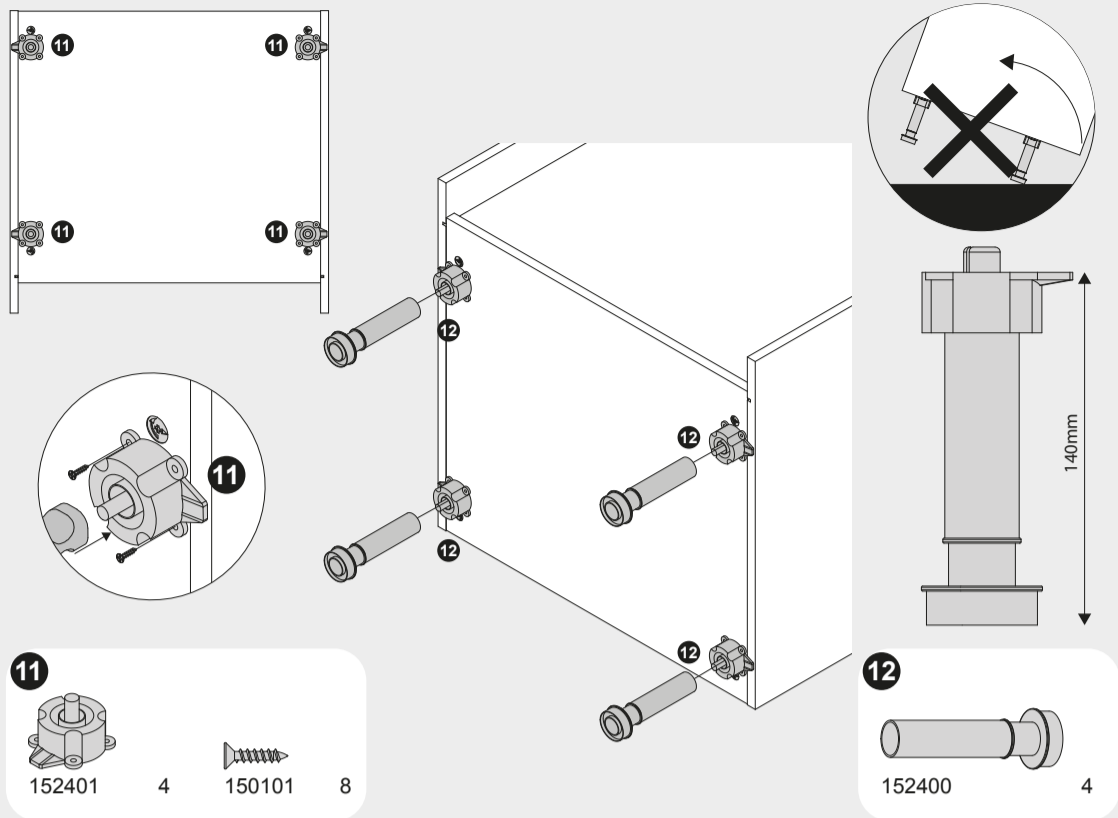

11
152401 4 150101 8

12
152400 4

13

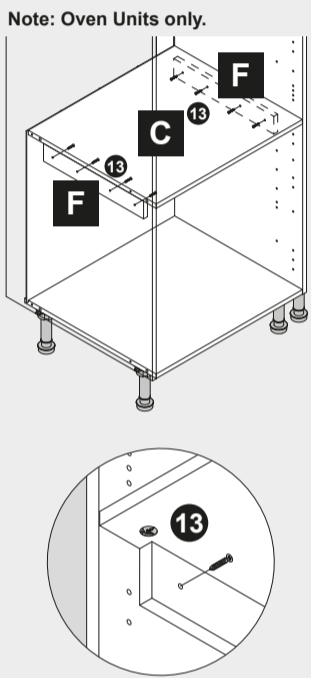

13
150124 8

14 — 15 Installation Instructions

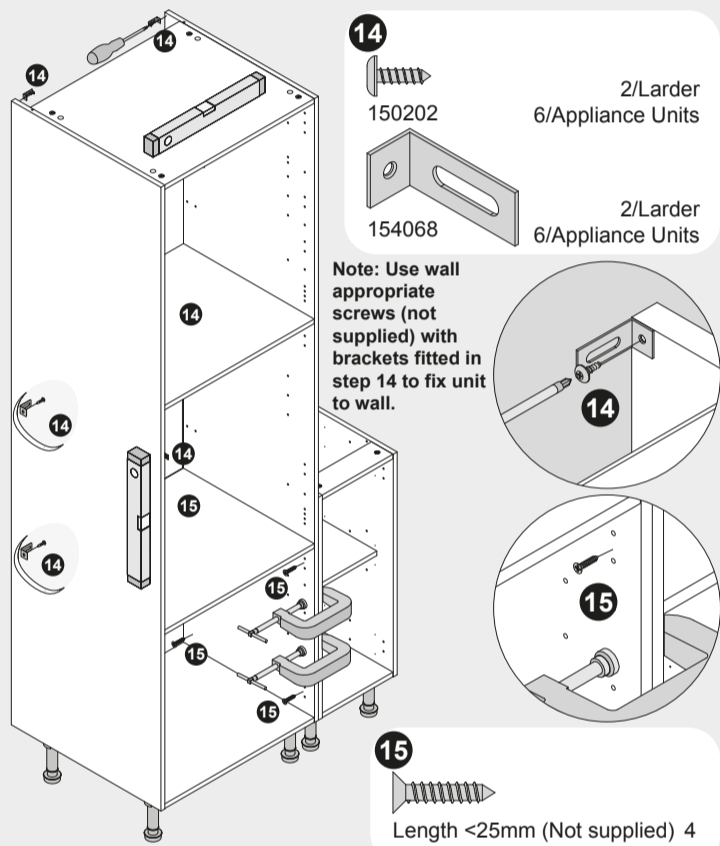

14
150202 2/Larder
6/Appliance Units
154068 2/Larder
6/Appliance Units

Note: Use wall appropriate screws (not supplied) with brackets fitted in step 14 to fix unit to wall.

15
Length <25mm (Not supplied) 4

16 — 18

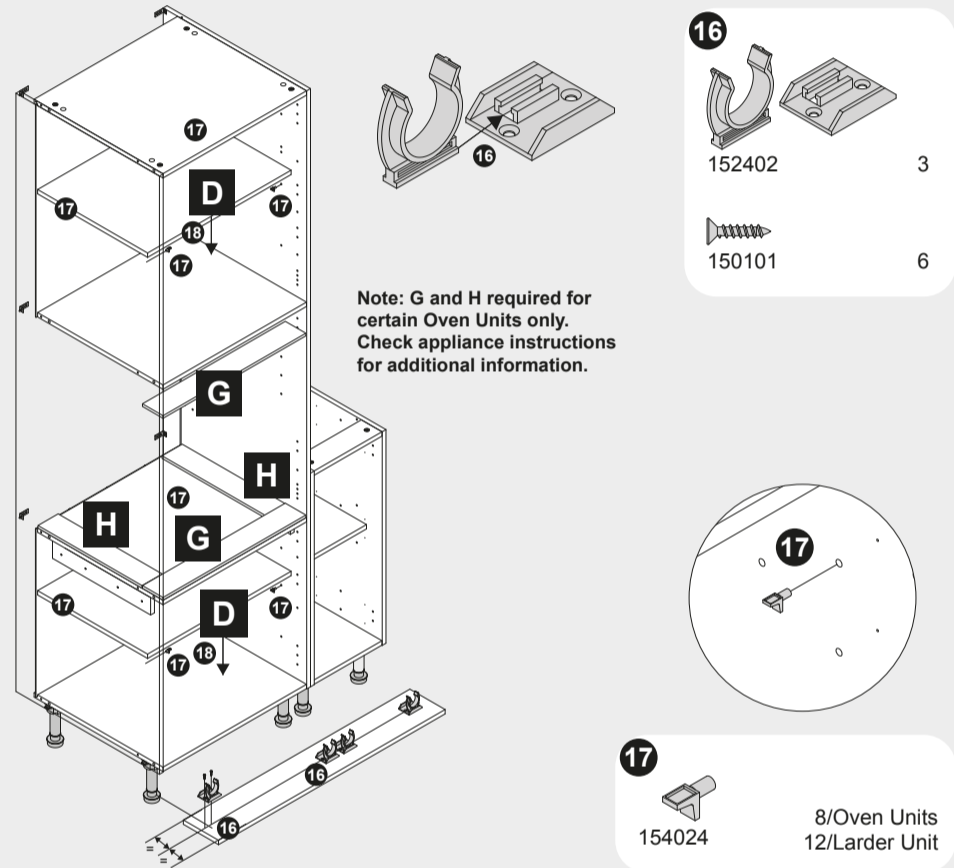

16
152402 3
150101 6

17
154024 8/Oven Units
12/Larder Unit

19 — 21

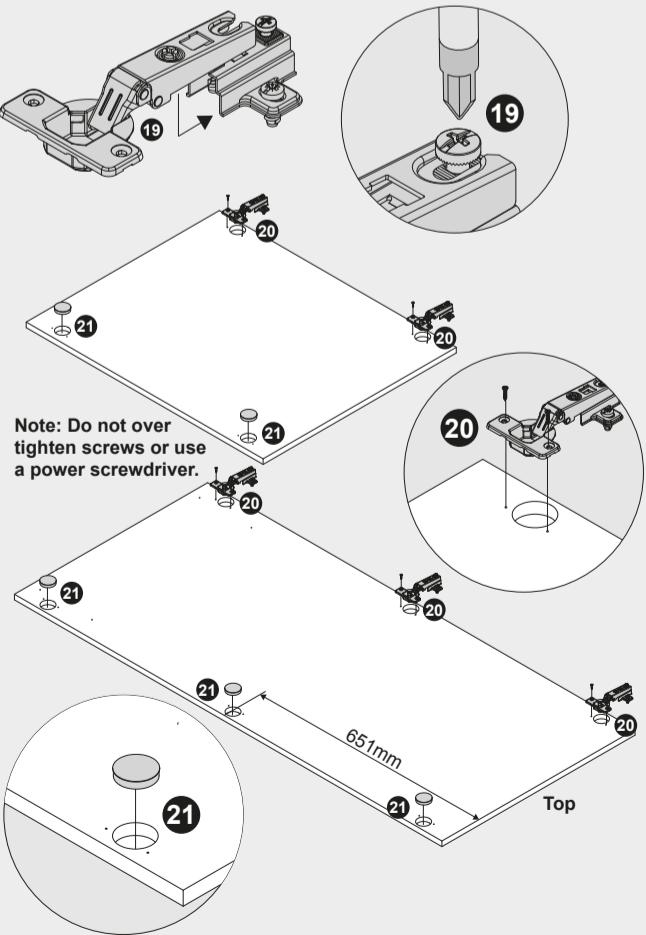

20
150101 8/Oven Units
10/Other Units

21
151701 2-5
(If required)

22 — 25

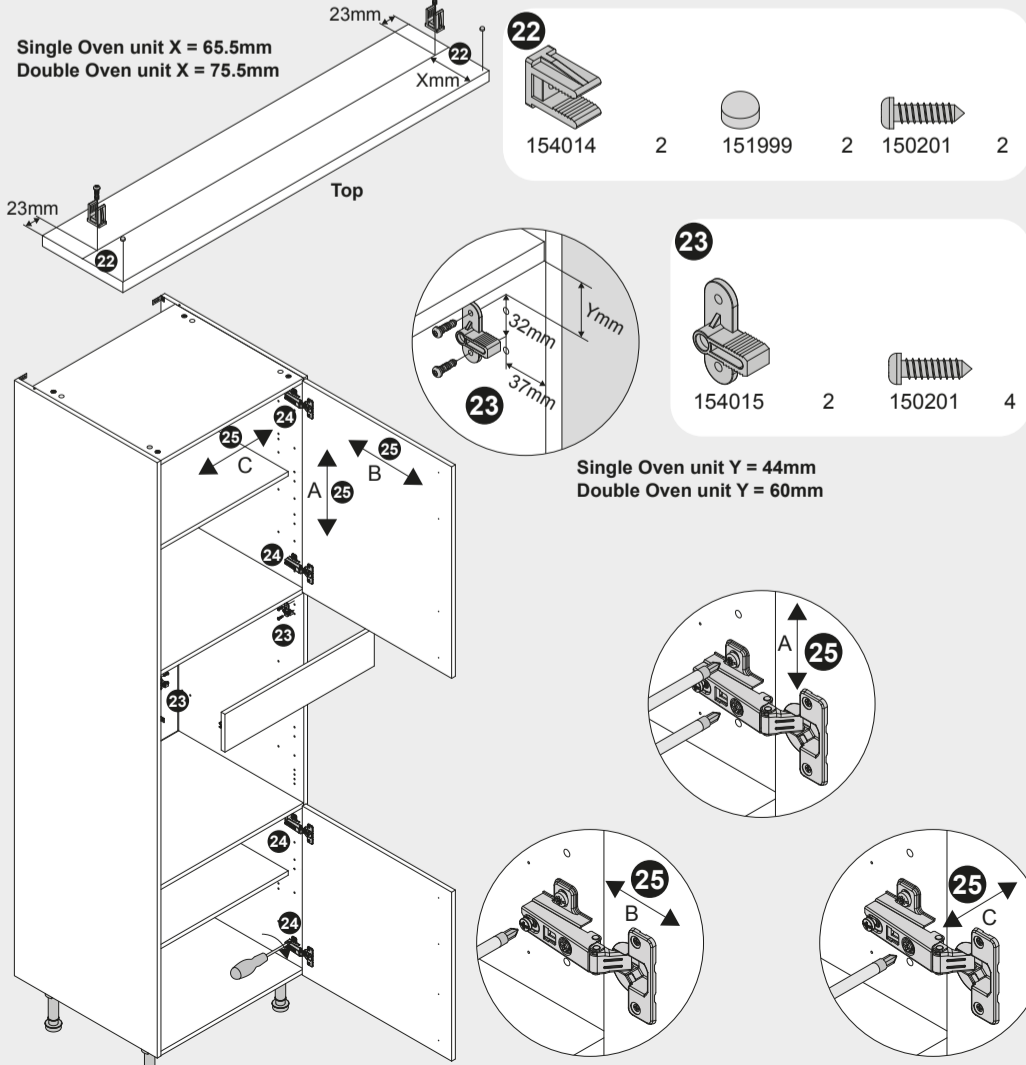

Single Oven unit X = 65.5mm
Double Oven unit X = 75.5mm

22
154014 2 151999 2 150201 2

23
154015 2 150201 4

Single Oven unit Y = 44mm
Double Oven unit Y = 60mm

26 — 27

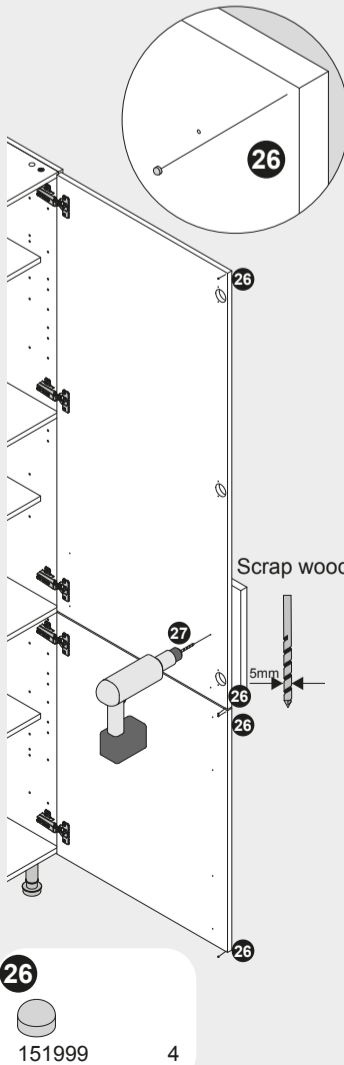

26
151999 4