



Built from experience



USER GUIDE & INSTALLATION INSTRUCTIONS

Classic Deluxe
Professional Deluxe
Elan Deluxe
110 Dual Fuel

U110658-05



RANGEmaster COOKWARE

Our range cookers are well known for providing the best possible cooking performance and years of faithful service.

However, a great cooker alone cannot guarantee perfect results every time. The other vital ingredients are of course enthusiasm and quality cookware.

We offer cookware to work perfectly with all fuel types manufactured by Rangemaster, including induction hobs. You can be assured of functionality with style, as well as the quality and meticulous attention to detail you expect from the pioneers of range cooking.

Visit www.rangemastercookshop.co.uk

Contents

1. Before You Start...	1	9. Troubleshooting	29
Personal Safety	1	10. Installation	31
Electrical Connection Safety	1	Dear Installer	31
If You Smell Gas	2	Safety Requirements and Regulations	31
Peculiar Smells	2	Provision of Ventilation	31
Ventilation	2	Location of Cooker	32
Maintenance	2	Conversion	32
Hob Care	4	Positioning the Cooker	33
Grill/Glide-out Grill™ Care	4	Moving the Cooker	33
Warming Zone Care	4	Fitting the Stability Bracket or Chain	34
Cooling Fan	4	Repositioning the Cooker Following Connection	35
Cooker Care	4	Conversion to Another Gas	35
Cleaning	5	Levelling	35
2. Cooker Overview	6	Gas Connection	36
Hotplate Burners	6	Electrical Connection	37
Wok Burner	7	Final Checks	37
The Wok Cradle	7	Final Fitting	37
The Ceramic Hotplate	8	Customer Care	37
The Griddle	9	11. Conversion to LP Gas	38
The Glide-out Grill™	9	Tap Adjustment	38
Bread Proving Drawer	10	Bypass Screw Adjustment	38
The Ovens	11	Stick on Label	38
Accessories	14	Pressure Testing	39
Oven Lights	14	12. Circuit Diagram	40
3. 2 Button - rotary clock	16	13. Technical Data	41
4. 3 Button clock	19		
5. 6 Button clock	21		
6. Cooking Tips	23		
7. Cooking Table	24		
8. Cleaning your cooker	25		
Essential information	25		
Hotplate burners	25		
The Griddle	26		
Glide-out Grill	26		
Ovens	27		
Cleaning table	28		

1. Before You Start...

Your cooker should give you many years of trouble-free cooking if installed and operated correctly. It is important that you read this section before you start.

Personal Safety

This appliance is for cooking purposes only. It must not be used for other purposes, for example heating a room. Using it for any other purpose could invalidate any warranty or liability claim. Besides invalidating claims this wastes fuel and may overheat the control knobs.

This appliance is for use in Great Britain and the Republic of Ireland. It is a Cat II_{2H3+} cooker and is set for G20 at 20 mbar. (A conversion kit for LPG is available for the cooker).

- This appliance can be used by children aged from 8 years and above and persons with reduced physical, sensory or mental capabilities or lack of experience and knowledge if they have been given supervision or instruction concerning use of the appliance in a safe way and understand the hazards involved.
- Children **less** than 8 years of age should be kept away unless continuously supervised. Children shall not play with the appliance. Cleaning and user maintenance shall not be made by children without supervision.
- The cooker should not be placed on a base.
- This appliance is designed for domestic cooking only. Use for any other purpose could invalidate any warranty or liability claim.
- Before operating the ovens please refer to the oven shelf installation, in the Accessories section.
- The appliance and its accessible parts become hot during use and will retain heat even after you have stopped cooking. Care should be taken to avoid touching heating elements.
- A long term cooking process has to be supervised from time to time. A short term cooking process has to be supervised continuously.
- At the risk of fire **DO NOT** store items on the cooking surfaces.
- To avoid overheating, **DO NOT** install the cooker behind a decorative door.
- Accessible parts will become hot during use and will retain heat even after you have stopped cooking. Keep babies and children away from the cooker and never wear loose-fitting or hanging clothes when using the appliance.
- **DO NOT** use a steam cleaner on your cooker.
- Always keep combustible materials, e.g. curtains, and flammable liquids a safe distance away from the cooker.

- **DO NOT** spray aerosols in the vicinity of the cooker while it is on.

Electrical Connection Safety

A Gas Safe registered engineer should service the cooker and only approved spare parts should be used.

The electrical installation must be installed in accordance with all relevant British Standards/Codes of Practice, BS 7671. Or with the relevant national and local regulations and with the local gas and electricity supply companies' requirements.

Otherwise, all installations must be in accordance with the relevant instructions in this booklet.

⚠ WARNING: THE APPLIANCE MUST BE EARTHED.

Note: The cooker must be connected to the correct electrical supply as stated on the voltage label on the cooker, through a suitable cooker control unit incorporating a double-pole switch, having a contact separation of at least 3 mm in all poles.

Read the instructions before installing or using this appliance.

Gas Connection Safety

- This cooker is a Class 2 Subclass 1 appliance.
- This appliance can be converted for use on another gas.
- Before installation, make sure that the cooker is suitable for your gas type and supply voltage. See the data badge.
- **DO NOT** use reconditioned or unauthorised gas controls.
- Disconnect from the electricity and gas supply before servicing.
- When servicing or replacing gas-carrying components disconnect from the gas supply before starting operation. Check the appliance is gas sound after completion.
- Make sure that the gas supply is turned on and that the cooker is wired in and switched on.
- In your own interest and that of safety, it is law that all gas appliances be installed by a qualified person(s).
- An appliance for use on LPG must not be installed in a room or internal space below ground level, e.g. in a basement.

This cooker must be installed in accordance with:

- British Standards/Codes of Practice, BS 5440 Part 2
- Natural Gas: BS 6172 and BS 6891
- LP Gas: BS 5482-1 (when the installation is in a permanent dwelling)
- Gas Safety (Installation and Use) regulations
- Relevant Building/IET regulations

If You Smell Gas

- **DO NOT** turn electric switches on or off
- **DO NOT** smoke
- **DO NOT** use naked flames
- Turn off the gas at the meter or cylinder
- Open doors and windows to get rid of the gas
- Keep people away from the area affected
- Call your gas supplier
- **If you are using Natural Gas in the UK, ring the National Grid on: 0800 111 999**

Peculiar Smells

When you first use your cooker it may give off an odour. This should stop after use.

Before using for the first time, make sure that all packing materials have been removed and then, to dispel manufacturing odours, turn the ovens to 200°C and run for at least an hour.

Before using the grill for the first time you should also turn on the grill and run for 30 minutes with the grill pan in position, pushed fully back and the grill door open.

Make sure the room is well ventilated to the outside air (see 'Ventilation' below). People with respiratory or allergy problems should vacate the area for this brief period.

Ventilation

The use of a cooking appliance results in the production of heat and moisture in the room in which it is installed. Therefore, make sure that the kitchen is well ventilated: keep natural ventilation holes open or install a powered cookerhood that vents outside. If you have several hotplates/burners on, or use the cooker for a long time, open a window or turn on an extractor fan

Maintenance

- It is recommended that this appliance is serviced annually.
- Before replacing the bulb, turn off the power supply and make sure that the oven is cool.
- **DO NOT** use cooking vessels on the hotplate that overlap the edges.
- Unless specified otherwise in this guide, always allow the cooker to cool and then switch it off at the mains before cleaning or carrying out any maintenance work.
- **DO NOT** use the control knobs to manoeuvre the cooker.
- **NEVER** operate the cooker with wet hands.
- **DO NOT** use a towel or other bulky cloth in place of a glove – it might catch fire if brought into contact with a hot surface.
- **DO NOT** use hotplate protectors, foil or hotplate covers of any description. These may affect the safe use of your hotplate burners and are potentially hazardous to health.
- **NEVER** heat unopened food containers. Pressure build up may make the containers burst and cause injury.
- **DO NOT** use unstable saucepans. Always make sure that you position the handles away from the edge of the hotplate.

- **NEVER** leave the hotplate unattended at high heat settings. Pans boiling over can cause smoking, and greasy spills may catch on fire. Use a deep fat thermometer whenever possible to prevent fat overheating beyond the smoking point.
- Unattended cooking on a hob with fat or oil can be dangerous and may result in fire.
- **NEVER** leave a chip pan unattended. Always heat fat slowly, and watch as it heats. Deep fry pans should be only one third full of fat.
- **NEVER** try to move a pan of hot fat, especially a deep fat fryer. Wait until the fat is cool. Filling the pan too full of fat can cause spill over when food is added. If you use a combination of oils or fats in frying, stir them together before heating, or as the fats melt.
- Foods for frying should be as dry as possible. Frost on frozen foods or moisture on fresh foods can cause hot fat to bubble up and over the sides of the pan. Carefully watch for spills or overheating of foods when frying at high or medium high temperatures.
- **DO NOT** use the top of the flue (the slot along the back of the cooker) for warming plates, dishes, drying tea towels or softening butter.
- **DO NOT** use water on grease fires and never pick up a flaming pan. Turn the controls off and then smother a flaming pan on a surface unit by covering the pan completely with a well fitting lid or baking tray. If available, use a multi-purpose dry chemical or foam-type fire extinguisher.
- **DO NOT** modify this appliance. This appliance is not intended to be operated by means of external timer or separated remote-control system.
- If flammable materials are stored in the drawer, oven(s) or grill(s) it may explode and result in fire or property damage.

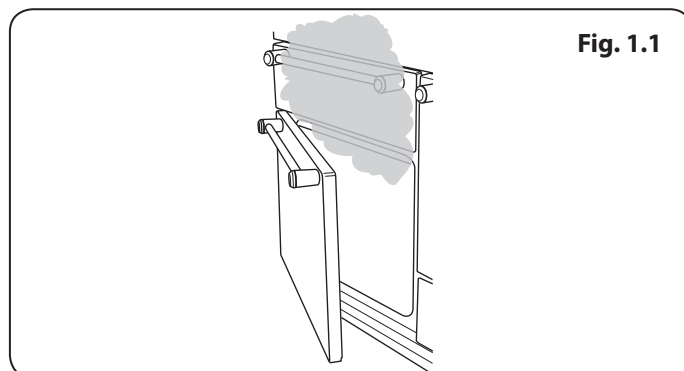

Fig. 1.1

Oven Care

- When the oven is not in use and before attempting to clean the cooker always be certain that the control knobs are in the **OFF** position.
- Use oven gloves to protect your hand from potential burns.
- Cooking high moisture content foods can create a 'steam burst' when the oven door is opened (**Fig. 1.1**). When opening the oven, stand well back and allow any steam to disperse.
- The inside door face is constructed with toughened safety glass. Take care **NOT** to scratch the surface when cleaning the glass panel.
- Accidental damage may cause the door glass panel to fracture.

- Keep oven vent ducts unobstructed.
- **DO NOT** use harsh abrasive cleaners or sharp metal scrapers to clean the oven door glass since they can scratch the surface, which may result in shattering of the glass.
- Make sure the shelves are pushed firmly to the back of the oven. **DO NOT** close the door against the oven shelves.
- **DO NOT** use aluminium foil to cover shelves, linings or the oven roof.
- When the oven is on, **DO NOT** leave the oven door open for longer than necessary, otherwise the control knobs may become very hot.
- **DO NOT** use the timed oven if the adjoining oven is already warm.
- **DO NOT** place warm food in the oven to be timed.
- **DO NOT** use a timed oven that is already warm.
- Use dry oven gloves when applicable – using damp gloves might result in steam burns when you touch a hot surface.

Hob Care

- **NEVER** allow anyone to climb or stand on the hob.
- **DO NOT** use the hob surface as a cutting board.
- **DO NOT** leave utensils, foodstuffs or combustible items on the hob when it is not in use (e.g. tea towels, frying pans containing oil).
- **DO NOT** place plastic or aluminium foil, or plastic containers on the hob.
- Always turn the control to the **OFF** position before removing a pan.
- Avoid heating an empty pan. Doing so may damage both the hob and pan.

Grill/Glide-out Grill™ Care

- When using the grill, make sure that the grill pan is in position and pushed fully in, otherwise the control knobs may become very hot.
- **DO NOT** leave the grill on for more than a few moments without the grill pan underneath it, otherwise the knobs may become hot.
- **NEVER** close the grill door when the grill is on.
- Accessible parts may be hot when the grill is in use. Young children should be kept away.

Warming Zone Care

- **NEVER** attempt to cook directly on the heating zone.
- **DO NOT** use the heating zone surface as a cutting board.
- **DO NOT** leave utensils, foodstuff or combustible items on the heating zone when it is not in use (e.g. tea towels, frying pans containing oil).
- **DO NOT** place plastic or aluminium foil, or plastic containers, on the heating zone.
- **DO NOT** leave the heating zone switched on unless being used for warming.
- **DO NOT** stand or rest heavy objects on the heating zone.

Although the ceramic surface is very strong, a sharp blow or sharp falling object (e.g. a salt cellar) might cause the surface to crack or break (**Fig. 1.2**)

⚠ Should a crack appear in the surface, disconnect the cooker immediately from the supply and arrange for its repair.

Always LIFT pans off the heating zone. Sliding pans may cause marks and scratches (**Fig. 1.3**). Always turn the control to the 'OFF' position before removing a pan.

- **DO NOT** place anything between the base of the pan and the heating zone surface (e.g. asbestos mats, aluminium foil, wok cradle).
- Take care **NOT** to place metallic objects such as knives, forks, spoons and lids on the hob surface since they can get hot.
- The appliance is not intended to be operated by means of external timer or separated remote-control system.
- Avoid warming an empty pan. Doing so may damage both the heating zone and pan.

Only certain types of glass, glass-ceramic, earthenware or other glazed containers are suitable for use on the heating zone; others may break because of the sudden change in temperature.

Cooling Fan

This appliance may have a cooling fan. When the grill or ovens are in operation the fan will run to cool the fascia and control knobs.

Cooker Care

As steam can condense to water droplets on the cool outer trim of the oven, it may be necessary during cooking to wipe away any moisture with a soft cloth. This will also help to prevent soiling and discolouration of the oven exterior by cooking vapours.

Cleaning

- Isolate the electricity supply before carrying out any thorough cleaning. Allow the cooker to cool.
- In the interests of hygiene and safety, the cooker should be kept clean at all times as a build up in fats and other food stuff could result in a fire.
- Clean only the parts listed in this guide.
- Clean with caution. If a wet sponge or cloth is used to wipe spills on a hot surface, be careful to avoid steam burns. Some cleaners can produce noxious fumes if applied to a hot surface.
- **NEVER** use paint solvents, washing soda, caustic cleaners, biological powders, bleach, chlorine based bleach cleaners, coarse abrasives or salt.
- **DO NOT** mix different cleaning products – they may react together with hazardous results.
- All parts of the cooker can be cleaned with hot soapy water.
- Take care that no water seeps into the appliance.
- Before you remove any of the grill parts for cleaning, make sure that they are cool or use oven gloves.
- **DO NOT** use any abrasive substances on the grill and grill parts.
- **DO NOT** put the side runners in a dishwasher.
- **DO NOT** put the burner heads in a dishwasher.
- **NEVER** use caustic or abrasive cleaners as these will damage the surface.
- **DO NOT** use steel wool, oven cleaning pads or any other materials that will scratch the surface.
- **NEVER** store flammable materials in the drawer. This includes paper, plastic and cloth items, such as cookbooks, plastic ware and towels, as well as flammable liquids.
- **DO NOT** store explosives, such as aerosol cans, on or near the appliance.
- **DO NOT** use steel wool, oven cleaning pads, or any other materials that will scratch the surface.
- **DO NOT** attempt to disassemble or clean around any burner while another burner is on, otherwise an electric shock could result.

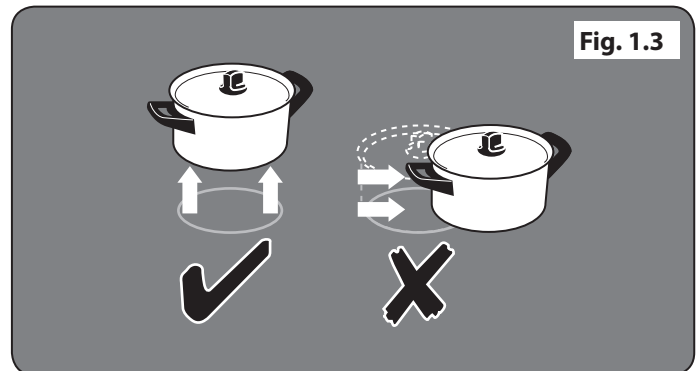
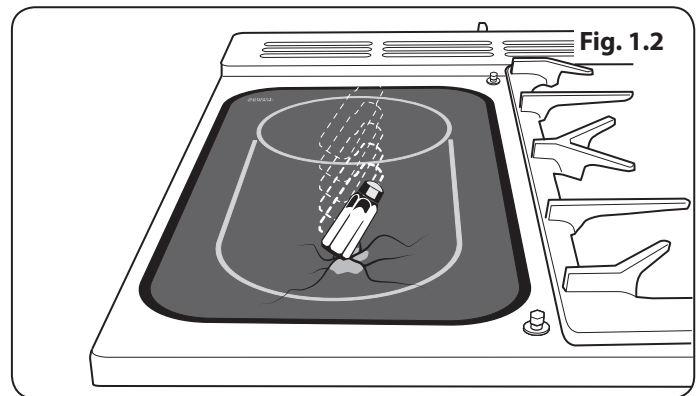

2. Cooker Overview

Fig. 2.1

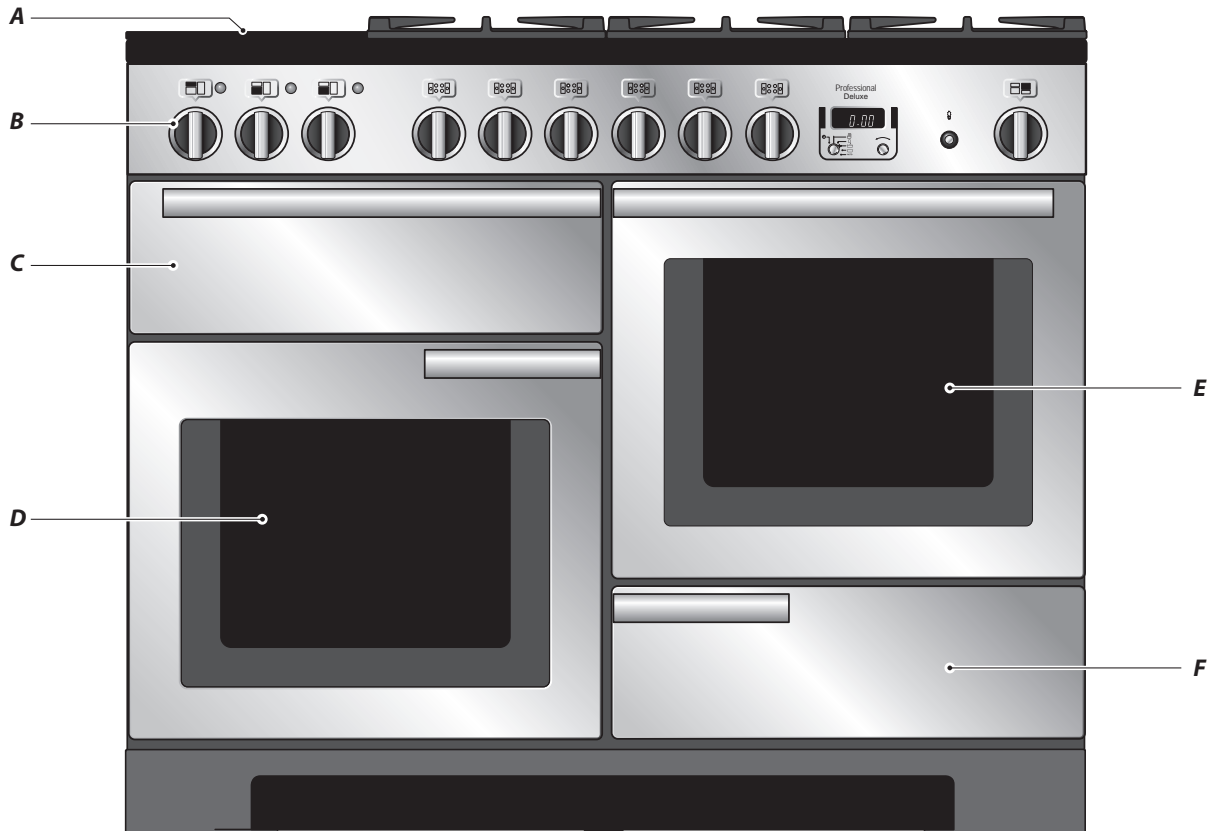

Fig. 2.2



This User Guide covers a number of different models. Although some of the illustrations will look different to your particular model the functions will be the same.

The 110 dual fuel cooker (**Fig. 2.1**) has the following features:

- A. 5 hotplate burners including a wok burner and ceramic multizone hotplate
- B. Control panel
- C. Glide-out grill
- D. Multifunction oven
- E. Fan oven
- F. Bread proving/Storage drawer

Hotplate Burners

The drawing by each of the central knobs indicates which burner that knob controls.

Each burner has a Flame Supervision Device (FSD) that prevents the flow of gas if the flame goes out.

When a hotplate control knob is pressed in, sparks will be made at every burner – this is normal. Do not attempt to disassemble or clean around any burner while another burner is on, otherwise an electric shock could result.

To light a burner, push in and turn the associated control knob to the high position as indicated by the large flame symbol (🔥), (**Fig. 2.2**).

The igniter should spark and light the gas. Keep holding the knob pressed in to let the gas through to the burner for about ten seconds.

If, when you let go of the control knob, the burner goes out, then the FSD has not been bypassed. Turn the control knob to the OFF position and wait for one minute before you try again, this time making sure to hold in the control knob for slightly longer.

Adjust the flame height to suit by turning the knob counter-clockwise (**Fig. 2.3**). On this cooker the low position is beyond high, not between high and off.

If a burner flame goes out, turn off the control knob and leave it for one minute before relighting it.

Make sure that the flames are under the pans. Using a lid will help the contents boil more quickly (**Fig. 2.4**).

Large pans should be spaced well apart.

Pans and kettles with concave bases or down-turned base rims should not be used (**Fig. 2.5**).

Simmering aids, such as asbestos or mesh mats, are NOT recommended (**Fig. 2.6**). They will reduce burner performance and could damage the pan supports.

You should also avoid using unstable and misshapen pans that may tilt easily, and pans with a very small base diameter, e.g. milk pans, single egg poachers (**Fig. 2.7**).

The minimum recommended pan diameter is 120 mm. The maximum allowable pan base diameter is 260 mm.

DO NOT use cooking vessels on the hotplate that overlap the edges.

Wok Burner

The wok burner is designed to provide even heat over a large area. It is ideal for large pans and stir-frying (**Fig. 2.8**).

For heating smaller pans, the aforementioned hotplate burners may be more efficient.

You should wipe the enamel top surface of the cooker around the hotplate burners as soon as possible after spills occur. Try to wipe them off while the enamel is still warm.

Note: The use of aluminium pans may cause metallic marking of the pan supports. This does not affect the durability of the enamel and may be cleaned off with a suitable metal cleaner.

The Wok Cradle

The wok cradle is designed to fit a 35 cm wok. If you use a different wok, make sure that it fits the cradle. Woks vary very widely in size and shape. It is important that the wok sits down on the pan support – however, if the wok is too small, the cradle will not support it properly (**Fig. 2.9**).

The cradle should be used on the wok burners only. When you fit the cradle, check that it is supported properly on a pan support and that the wok is sitting level in the cradle (**Fig. 2.10**).

The cradle will get very hot in use – allow plenty of time for it to cool before you pick it up.

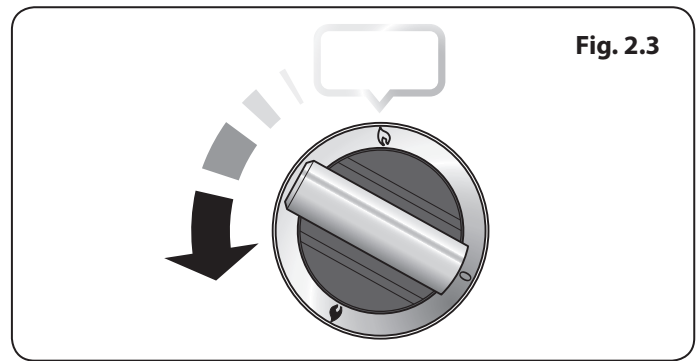

Fig. 2.3

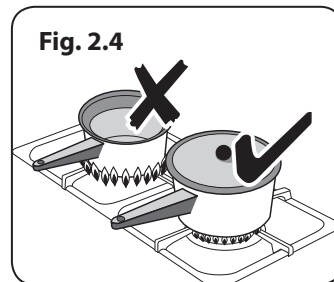

Fig. 2.4

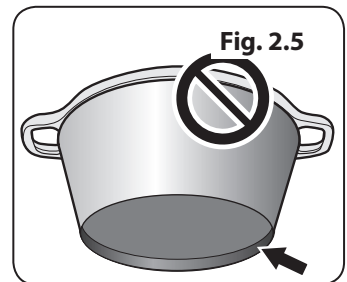

Fig. 2.5

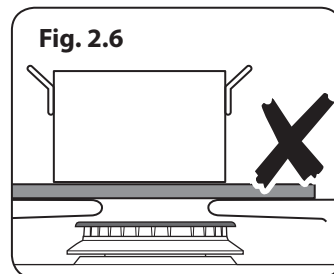

Fig. 2.6

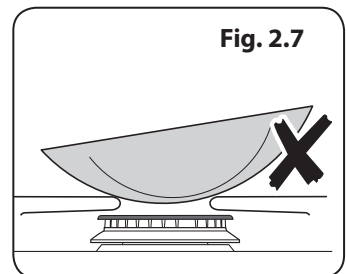

Fig. 2.7

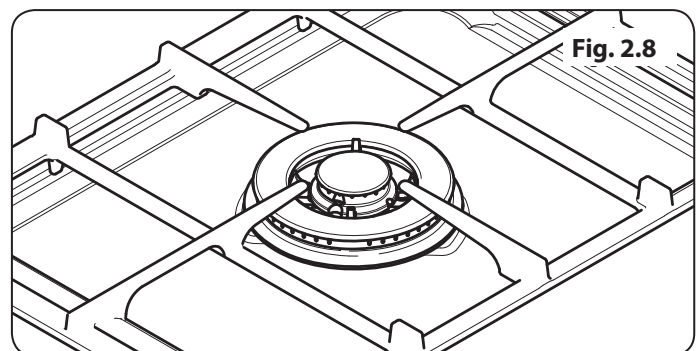

Fig. 2.8

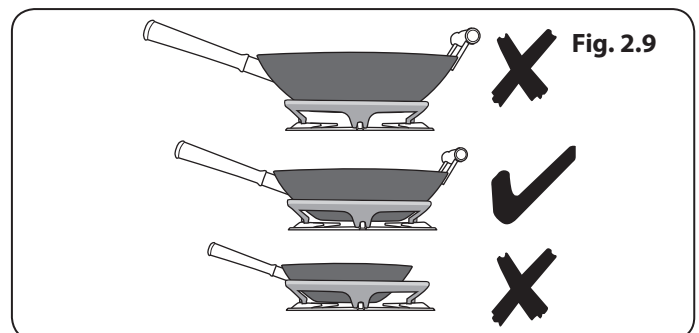

Fig. 2.9

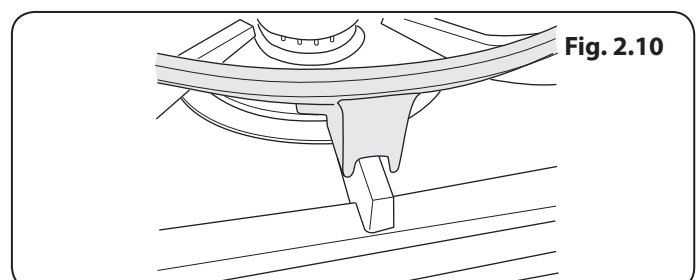

Fig. 2.10

Fig. 2.11

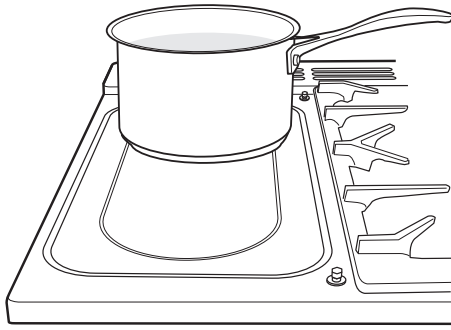

Fig. 2.12

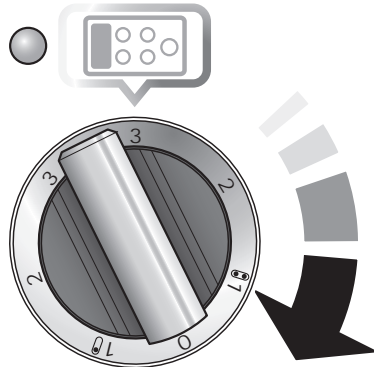

Fig. 2.13

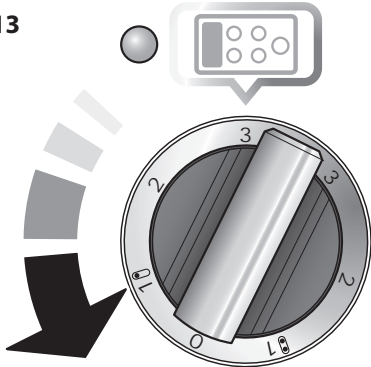

Fig. 2.14

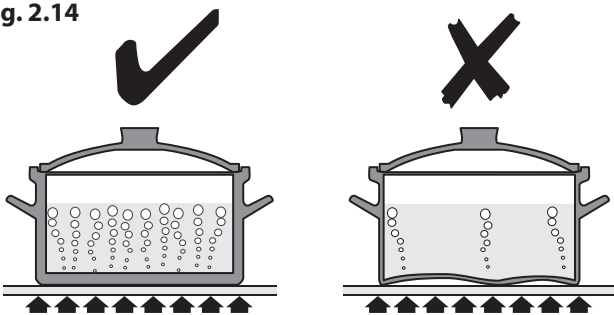
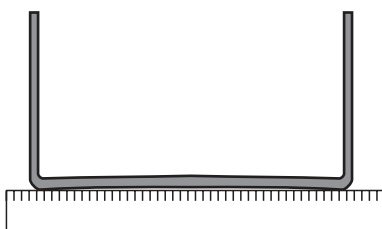

Fig. 2.15



The Ceramic Hotplate

The hotplate area on the left-hand side is dual purpose. It can be used either as a ceramic hob to heat a pan in the usual way (**Fig. 2.11**) or it can be used to heat the supplied griddle.

The rear area, marked with a ring, is for cooking with a pan.

There are two elements that allow either the whole of the area to be heated or just the rear half.

To heat the whole area, turn the hotplate control clockwise (**Fig. 2.12**).

To use the rear ring only, turn the hotplate control counter-clockwise (**Fig. 2.13**).

The neon indicator light above the control knob will come on when the hotplate control is turned on and stay lit while the surface cools.

You can also place a large fish kettle across both heating zones.

Always take care before touching the surface even when it is turned off – it may be hotter than you think.

Use only pans that are suitable for ceramic hobs.

We recommend stainless steel and enamelled steel pans because pots and pans with copper or aluminium bases leave traces on the hob that are difficult to remove.

Pots and pans should have thick, smooth, flat bottoms (**Fig. 2.14**). This makes sure the maximum heat transfer from the hob to the pan, making cooking quick and energy efficient. Never use a round-bottomed wok, even with a stand.

The very best pans have bases that are very slightly curved up when cold. If you hold a ruler across the bottom you will see a small gap in the middle (**Fig. 2.15**). When they heat up the metal expands and lies flat on the cooking surface.

Make sure that the base of the pan is clean and dry to prevent any residue burning onto the hob panel. This also helps prevent scratches and deposits.

Always use pans that are the same size as (or slightly larger than) the areas marked on the hob top. Using smaller pans wastes heat, and any spillage will be burnt on. Using a lid will help the contents boil more quickly.

Always lift pans off the hob. Sliding pans may cause marks and scratches. Always turn the control to the 'OFF' position before removing a pan.

When cooking on the hob you may see the hob area you are using switch off and on. This is caused by a safety device that limits the temperature of the hob. It is quite normal, especially when cooking at high temperatures. If it happens a lot with a particular pan however it may mean the pan is not suitable – perhaps too small or too uneven – for a ceramic hob.

For best results, preheat a covered serving dish for 10 minutes before adding food to it.

Use only heat-resistant dishes.

The Griddle

The griddle is designed to fit securely on the locating pins over the ceramic heating area (**Fig. 2.16**). **Do not** try to use it over one of the gas burners. It will not be securely held and you may damage the non-stick finish.

To heat the whole area, turn the hotplate control clockwise (**Fig. 2.17**).

The neon indicator light above the control knob will come on when a hob control is turned on and stay lit while the surface cools.

It is designed for cooking food on directly. **DO NOT** use pans of any kind on it. The griddle surface is non-stick and metal cooking utensils (e.g. spatulas) will damage the surface. Use heat resistant plastic or wooden utensils.

The griddle can be lightly brushed with cooking oil before use.

Preheat the griddle for a **maximum of 5 minutes** before adding food. Leaving it longer may cause damage.

There is a gap at the right-hand rear corner of the griddle (**Fig. 2.18**) so you can pour off excess fat after cooking.

⚠ Be careful – it may be very hot.

After cooking, allow the griddle to cool before cleaning.

The Glide-out Grill™

Open the door and pull the grill pan carriage forward using the handle (**Fig. 2.19**).

The grill has two elements that allow either the whole area of the pan to be heated or just the right-hand half.

To heat the whole grill, turn the knob clockwise (**Fig. 2.20**).

To heat the right-hand half, turn the knob counter-clockwise. The neon indicator light by the grill control will come on.

For best results, slide the carriage back into the grill chamber and preheat the appropriate part(s) of the grill for two minutes. The grill trivet can be removed and the food placed on it while you are waiting for the grill to preheat.

⚠ DO NOT leave the grill on for more than a few moments without the grill pan underneath it, otherwise the knobs may become hot.

Once the grill has preheated, slide the carriage out again. With the trivet back in place with the food on it, slide the carriage back into the grill chamber. Make sure that it is pushed right in.

⚠ Accessible parts may be hot when the grill is in use. Young children should be kept away.

The grill pan trivet can be set to four different grilling heights by a combination of turning it back to front and turning it upside down (**Fig. 2.21**).

⚠ Never close the grill door when the grill is on.

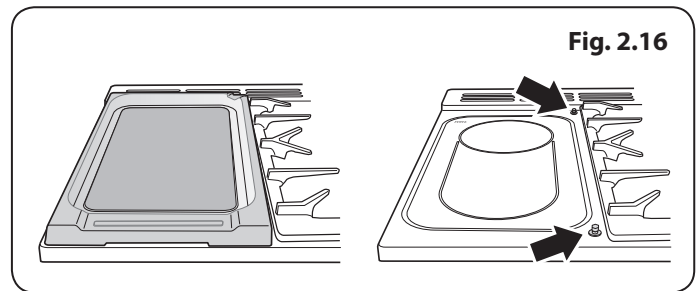

Fig. 2.16

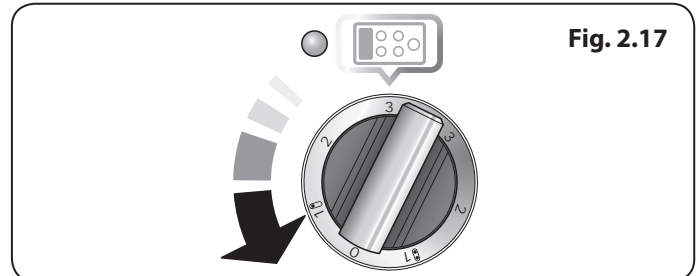

Fig. 2.17

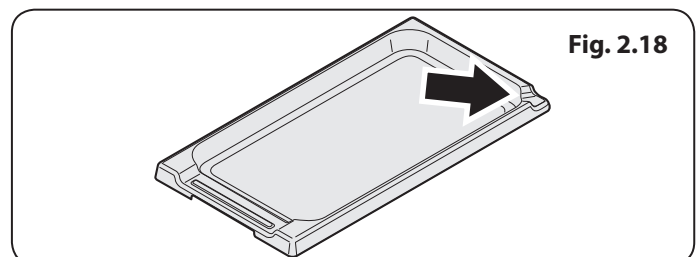

Fig. 2.18

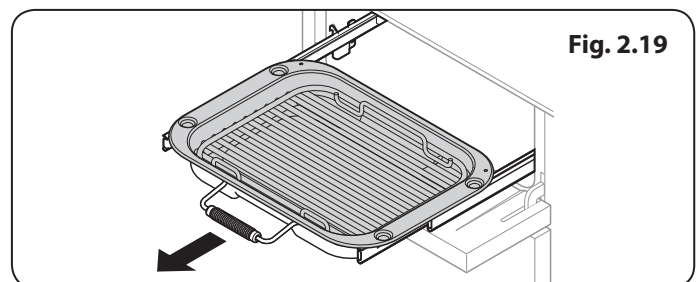

Fig. 2.19

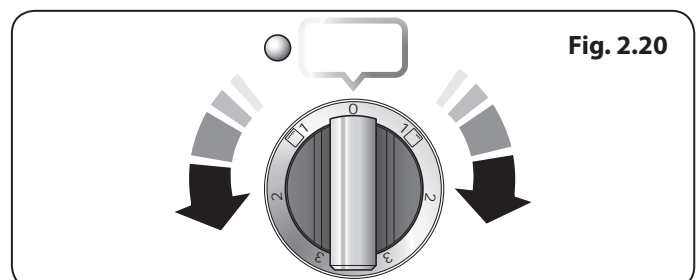

Fig. 2.20

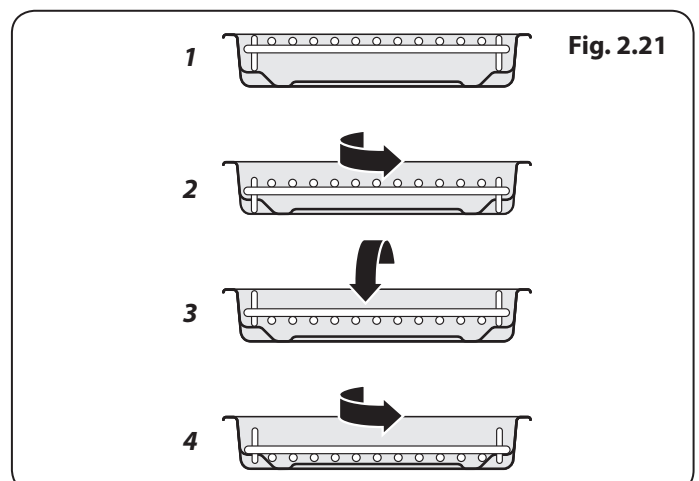
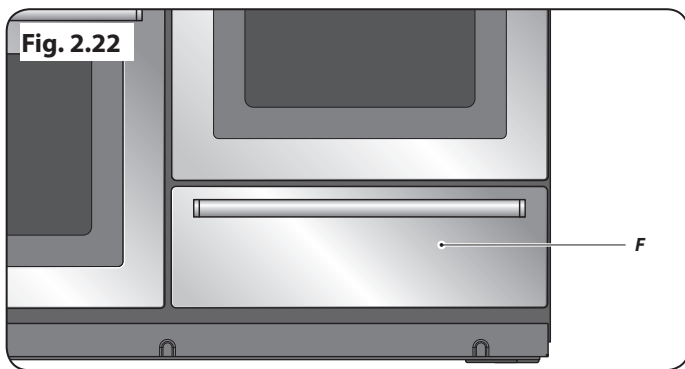

Fig. 2.21



Bread Proving Drawer

The Bread Proving Drawer is found on the right at the base of the cooker (**Fig. 2.22**). Within the Bread Proving Drawer there are slots in the base to allow warmed air to flow through into the drawer from the element underneath.

The Bread Proving Drawer temperature is ideal for proving all sorts of yeast dough from sweet to savoury, gluten free to sourdough, dough made from fresh yeast and dried, bread mixes and recipes from the Rangemaster Good Housekeeping Cookery book.

Pre heat the drawer so that it is warm and ready for your dough.

It is operated by a pushbutton (**Fig. 2.23**). There is no need to set the temperature, this is already set.

The Bread Proving Drawer has space for:

- Baking trays, no larger than 340mm x 340mm, to prove bread rolls or buns; these can then be put straight into a preheated oven after proving.
- To prove 2 trays at once in the drawer use a cooling rack or trivet over the top of one tray with the other on top, remember to allow space for the dough to expand during the proving time.
- 3 litre bowl full of dough
- 3 x 2 pound loaf tins
- 4 x 1 pound loaf tins

The time needed for proving will depend upon the dough type and the amount. Refer to the recipe for guidance and check the dough during the proving time.

If a large baking tray is used, place a cooling rack on to the base of the drawer, and put the tray on top, this will allow the warmed air to reach the dough.

When preparing larger quantities of yeast dough, containing 500g or over of flour, divide the dough into 2 bowls or containers, this will make proving in the drawer easier.

Keep an eye on the dough while it is proving; fresh yeast can work quickly especially if it has had a first fermentation stage (sometimes called sponging). Sponging can help produce a slightly lighter loaf.

TOP TIPS

Not sure of the capacity of your loaf tins?

- A one pound loaf tin will hold 800ml of water
- A two pound loaf tin will hold 1.5 litres of water.
- Cover the dough while it is proving with greased cling film, be careful not to anchor the cling film too tightly so that it prevents the dough from rising.

The Bread Proving Drawer can be used for storage. If you have used the Bread Proving Drawer, switch it off and wait until the drawer cools before storing any items.

NOTE: The Bread Proving Drawer will not warm plates

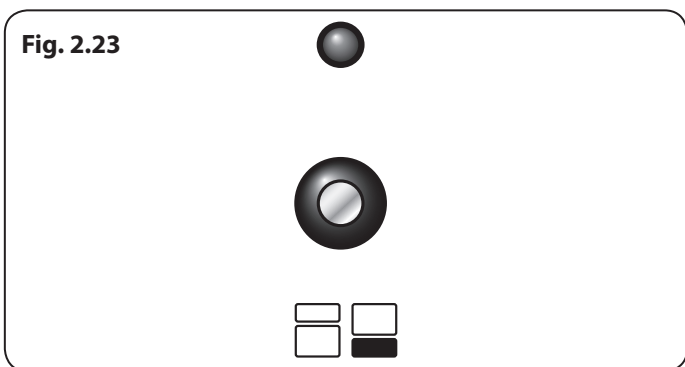

Cleaning

Clean the inside of the drawer with hot soapy water and a soft cloth, rinse and dry.

The Bread Proving Drawer is ideal for storing baking trays and other cooking utensils.

It can get warm, so do not store anything in it that may melt or catch fire.

⚠ Never store flammable materials in the drawer. This includes paper, plastic and cloth items, such as cookbooks, plastic ware and towels, as well as flammable liquids.

⚠ Do not store explosives, such as aerosol cans, on or near the appliance.

⚠ Flammable materials may explode and result in fire or property damage.

The Ovens

The clock must be set to the time of day before the ovens will work. See the following section on 'The Clock' for instructions on setting the time of day.

References to 'left-hand' and 'right-hand' ovens apply as viewed from the front of the appliance.

The left-hand oven is a multifunction oven, while the right-hand oven is a fan oven.

The Multifunction Oven

As well as the oven fan and fan element, multifunction ovens are fitted with two extra heating elements, one visible in the top of the oven and the second under the oven base. Take care to avoid touching the top element and element deflector when placing or removing items from the ovens.

The multifunction oven has 3 main cooking functions: **fan**, **fan assisted** and **conventional cooking**. These functions should be used to complete most of your cooking.

The **browning element** and **base heat** can be used in the latter part of the cooking process to fine tune the results to your particular requirements.

Use **fanned grilling** for all your grilling needs and **defrost** to safely thaw small items of frozen food.

Table 2.1 gives a summary of the multifunction modes.

The multifunction ovens have many varied uses. We suggest you keep a careful eye on your cooking until you are familiar with each function. Remember – not all functions will be suitable for all food types.

Please remember that all cookers vary – temperatures in your new ovens may differ to those in your previous cooker.

Function	Use
Defrost	To thaw small items in the oven without heat
Fan oven	A full cooking function, even heat throughout, great for baking
Fanned grilling	Grilling meat and fish with the door closed
Fan assisted	A full cooking function good for roasting and baking
Conventional oven	A full cooking function for roasting and baking in the lower half of the oven
Browning element	To brown and crisp cheese topped dishes
Base heat	To crisp up the bases of quiche, pizza or pastry

Table 2.1

Multifunction Oven Functions

Rapid Response

 The Rapid Response setting enables you to preheat the oven faster than normal. It uses the fan oven element with additional heat from one of the elements in the top of the oven. The fan ovens heat up quickly; but the Rapid Response feature speeds this process up enabling you to start cooking sooner.

To use the Rapid Response feature, simply turn the function control knob to R and set the temperature you require. The light on the control panel next to the R symbol will come on. When temperature is reached, the light will go out as will the element at the top of the oven. The fan element and oven fan will then continue to maintain your chosen oven temperature.

Should you choose to place food into the cold oven prior to cooking whilst using the Rapid Response function, make sure that cakes etc. are not positioned too near the top of the oven. As with any cooking, particularly poultry, meat and ready meals, be sure the food is piping hot before serving.

Fan Oven

 This function operates the fan and the heating element around it. An even heat is produced throughout the oven, allowing you to cook large amounts quickly.

Fan oven cooking is particularly suitable for baking on several shelves at one time and is a good 'all-round' function. It may be necessary to reduce the temperature by approximately 10°C for recipes previously cooked in a conventional oven.

If you wish to preheat the oven, wait until the indicator light has gone out before inserting the food.

Fanned Grilling

 This function operates the fan whilst the top element is on. It produces a more even, less fierce heat than a conventional grill. For best results, place the food to be grilled on a trivet over a roasting tin, which should be smaller than a conventional grill pan. This allows greater air circulation. Thick pieces of meat or fish are ideal for grilling in this way, as the circulated air reduces the fierceness of the heat from the grill.

The oven door should be kept closed while grilling is in progress, so saving energy. You will also find that the food needs to be watched and turned less than for normal grilling. Preheat this function before cooking.

For best results we recommend that the grill pan is not located on the uppermost shelf.

Fan Assisted Oven

 This function operates the fan, circulating air heated by the elements at the top and the base of the oven. The combination of fan and conventional cooking (top and base heat) makes this function ideal for cooking large items that need thorough cooking, such as a large meat roast.

It is also possible to bake on two shelves at one time, although they will need to be swapped over during the cooking time, as the heat at the top of the oven is greater than at the base, when using this function.

This is a fast intensive form of cooking; keep an eye on the food cooking until you have become accustomed to this function.

Conventional Oven (Top and Base Heat)

 This function combines the heat from the top and base elements. It is particularly suitable for roasting and baking pastry, cakes and biscuits.

Food cooked on the top shelf will brown and crisp faster than on the lower shelf, because the heat is greater at the top of the oven than at the base, as in 'Fan Assisted Oven' function. Similar items being cooked will need to be swapped around for even cooking. This means that foods requiring different temperatures can be cooked together, using the cooler zone in the lower half of the oven and hotter area to the top.

The exposed top element may cook some foods too quickly, so we recommend that the food be positioned in the lower half of the oven to cook. The oven temperature may also need to be lowered.

Browning Element

 This function uses the element in the top of the oven only. It is a useful function for the browning or finishing of pasta dishes, vegetables in sauce, shepherds pie and lasagne, the item to be browned being already hot before switching to the top element.

Base Heat

 This function uses the base element only. It will crisp up your pizza or quiche base or finish off cooking the base of a pastry case on a lower shelf. It is also a gentle heat, good for slow cooking of casseroles in the middle of the oven or for plate warming.

The Browning and Base Heat functions are useful additions to your oven, giving you flexibility to finish off items to perfection.

Defrost

 This function operates the fan to circulate cold air only. Make sure the temperature control is at 0°C and that no heat is applied. This enables small items such as desserts, cream cakes and pieces of meat, fish and poultry to be defrosted.

Defrosting in this way speeds up the process and protects the food from flies. Pieces of meat, fish and poultry should be placed on a trivet, over a tray to catch any drips. Be sure to wash the trivet and tray after defrosting.

Defrost with the oven door closed.

Large items, such as whole chickens and joints should not be defrosted in this way. We recommend this be carried out in a refrigerator.

Defrosting should not be carried out in a warm oven or when an adjoining oven is in use or still warm.

Make sure that dairy foods, meat and poultry are completely defrosted before cooking.

Fan Oven

The right-hand oven is a fan oven that circulates hot air continuously, which means faster, more even cooking.

The recommended cooking temperatures for a fan oven are generally lower than a conventional oven.

Note: Please remember that all cookers vary so temperatures in your new ovens may differ to those in your previous cooker.

Operating the Multifunction Oven

The multifunction oven has two controls: a function selector and a temperature setting knob (Fig. 2.24).

Turn the function selector control to a cooking function. Turn the oven temperature knob to the temperature required (Fig. 2.25).

The oven heating light will glow until the oven has reached the temperature you selected (Fig. 2.26). It will then cycle on and off during cooking as the oven maintains the selected temperature.

Operating the Fan Oven

Turn the oven knob to the desired temperature (Fig. 2.25).

The oven indicator light will glow until the oven has reached the temperature selected (Fig. 2.26). It will then cycle on and off during cooking.

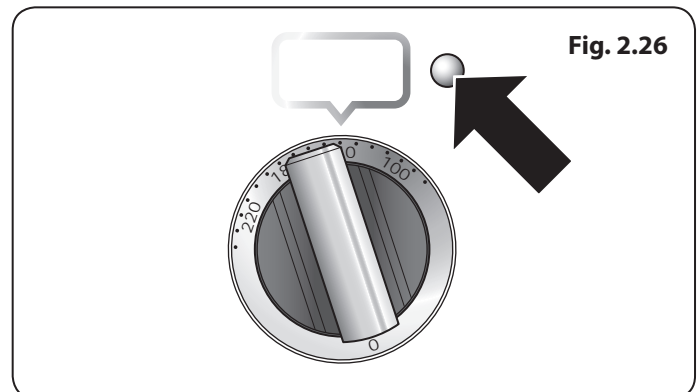
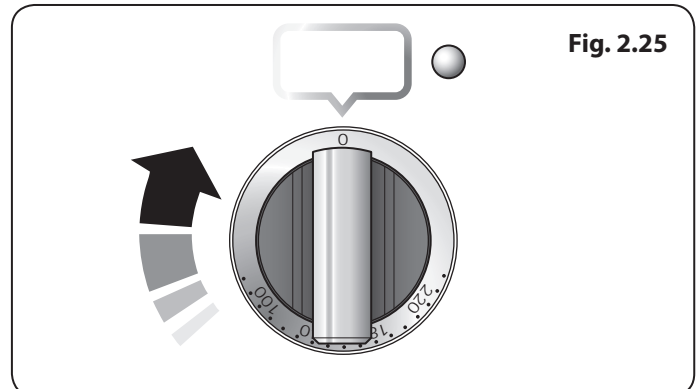
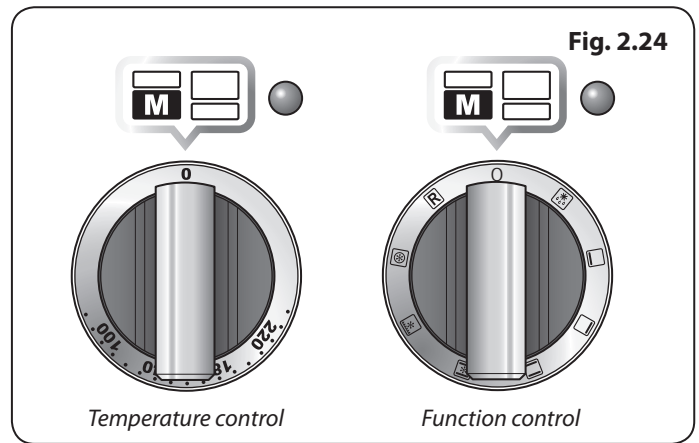

Fig. 2.27

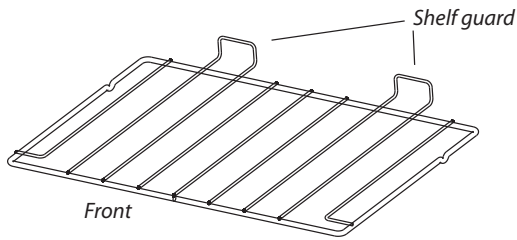

Fig. 2.28

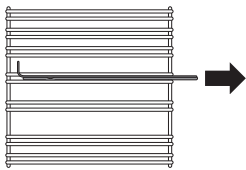

Fig. 2.29

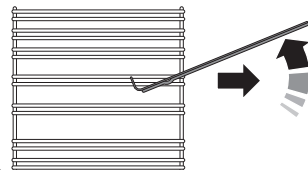

Fig. 2.30

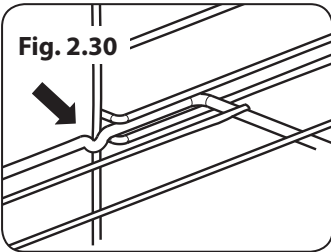

Fig. 2.31

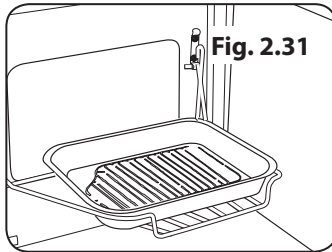

Fig. 2.32

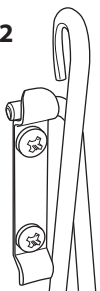

Fig. 2.33

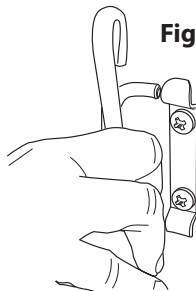

Fig. 2.34



Accessories

Oven Shelves

The oven shelves (**Fig. 2.27**) are retained when pulled forward but can be easily removed and refitted.

Pull the shelf forward until the back of the shelf is stopped by the shelf stop bumps in the oven sides (**Fig. 2.28**).

Lift up the front of the shelf so the back of the shelf will pass under the shelf stop and then pull the shelf forward (**Fig. 2.29**).

To refit the shelf, line up the shelf with a groove in the oven side and push the shelf back until the ends hit the shelf stop. Lift up the front so the shelf ends clear the shelf stops, and then lower the front so that the shelf is level and push it fully back (**Fig. 2.30**).

The Handyrack (Left-hand Oven)

The Handyrack (**Fig. 2.31**) fits to the left-hand oven door only. Food cooking on it is easy to attend to, because it is accessible when the door is open.

The maximum weight that can be held by the Handyrack is 5.5 kg (12 lb). It should only be used with the supplied roasting tin, which is designed to fit the Handyrack. Any other vessel could be unstable.

It can be fitted at two different heights. One of the oven shelves must be removed and the other positioned to suit.

When the Handyrack is used in its highest position, other dishes can be cooked on the bottom shelf position or base of the oven. When the Handyrack is used in its lowest position, other dishes can be cooked on the second shelf position or base of the oven.

To fit the Handyrack, locate one side of it on the door bracket (**Fig. 2.32**). Then spring the other side out to clip it onto the other bracket (**Fig. 2.33**).

Oven Lights

Press the button to turn the lights on (**Fig. 2.34**).

If the oven light fails, turn off the power supply before changing the bulb. See the 'Troubleshooting' section for details on how to change the bulb.

Glide-out Oven Shelf (optional)

Glide-out oven shelves are available for either oven (**Fig. 2.35**).

Note: The Handyrack must be removed before fitting the glide-out shelf.

The rungs on the shelf supports are in pairs. The glide-out shelf runners can be fitted to any pair except the top.

To fit the glide-out shelf runners

Hook the rear of the runner over the top rung of a pair of shelf supports. Then hook the front of the runner onto the same rung. Push to clip under the bottom rung (**Fig. 2.36**).

The front of the shelf runners can be identified by the bracket (**Fig. 2.38**).

Ensure that the shelf runners are fitted in the same position on each side (**Fig. 2.37**).

To fit the glide-out shelf

Check the shelf runners are secure before fitting the glide-out shelf.

Hook the front of the glide-out oven shelf onto the runners as shown (**Fig. 2.38**). The rear of the shelf should rest on the runners, in front of the rear stop (**Fig. 2.38**).

Ensure that the shelf sits flat once in position.

⚠ DO NOT put the glide-out shelf runners in a dishwasher

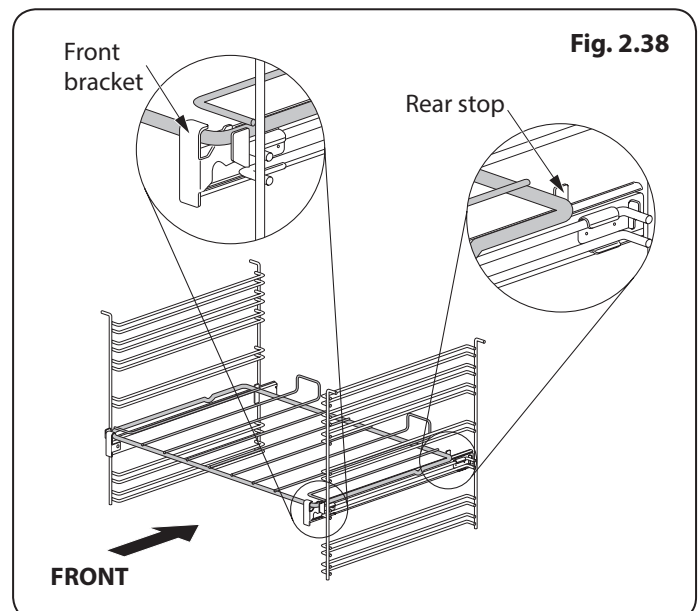
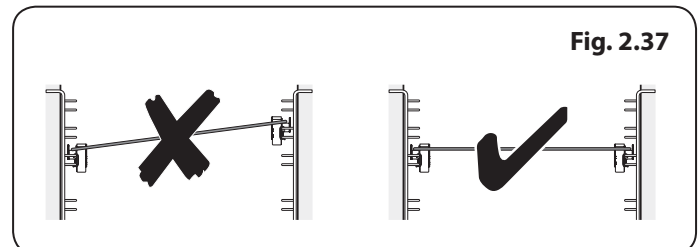
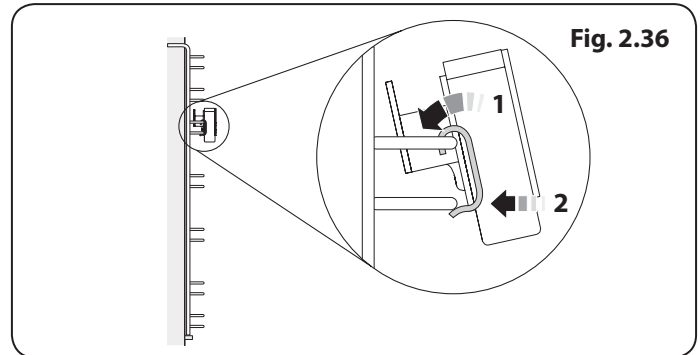
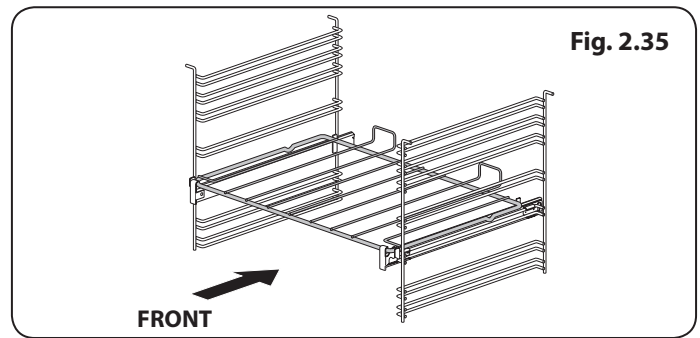

3. 2 Button - rotary clock

Fig. 3.1

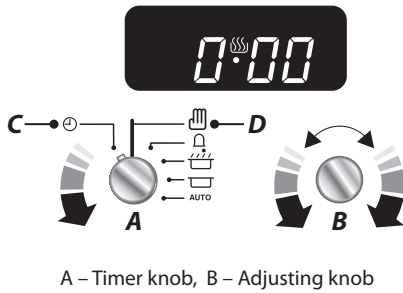

Fig. 3.2

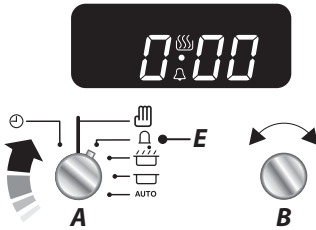

Fig. 3.3

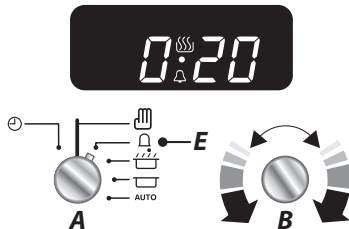
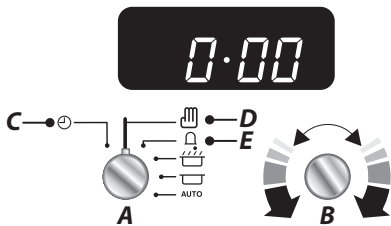

Fig. 3.4



The clock must be set to the time of day before the oven will work.

Setting the Clock

1. Once the cooker is connected and switched on, the display will start to flash.
2. To set the time, turn the **Timer (A)** knob to the **Clock (C)** setting and back to the **Manual (D)** position. The centre dot will flash indicating the time can be set. Turn the **Adjusting (B)** knob either clockwise or counter-clockwise (**Fig. 3.1**) to set the time.
3. Once you have set the time, allow the centre dot to stop flashing, the time is now set.

Setting the minute minder

A **Minute Minder (E)** is a feature that can be set for a number of minutes and sounds an alarm once the specified amount of time has elapsed.

1. Turn the **Timer (A)** knob to the **Minute Minder (E)** setting – it should click into position (**Fig. 3.2**).
2. Turn the **Adjusting (B)** knob to set the amount of time required. Minimum time 1 minute (**Fig. 3.3**).
3. Turn the **Timer (A)** knob back to the **Manual (D)** setting to see the current time and the 'Bell' symbol on the display.

Cancel the timer alarm

Once the specified time has elapsed it will emit an alarm. There are two ways to cancel the alarm:

1. Turn the **Adjusting (B)** knob counter-clockwise or clockwise (**Fig. 3.4**).
2. Turn the **Timer (A)** knob to the **Clock (C)** or the **Minute Minder (E)** setting, and back to the **Manual (D)** mode, to return to normal cooking (**Fig. 3.4**).

NOTE

If the alarm is not manually switched off it will stop after approximately 2 minutes.

When the Minute Minder is active the clock will not dim between the hours of 10 pm and 6 am

To stop the oven at a specific time of day

You have set the required temperature and function mode and you would like the oven to automatically stop.

TOP TIP

Make a note of the current time so you do not forget.

1. Turn the **Timer (A)** knob to the **Stop Time (G)** setting. 'AUTO' will show in the display (**Fig. 3.5**).
2. Turn the **Adjusting (B)** knob to the amount of cooking time required. The display will show the current time plus the additional cooking time you have set (**Fig. 3.6**).
3. Turn the **Timer (A)** knob to the **Auto (H)** setting. The display will show the current time, the cooking symbol and the word 'AUTO' (**Fig. 3.7**).
4. Once the specified time has elapsed it will emit an alarm and the oven will stop working. The cook pot symbol on the display will disappear and the word 'AUTO' will flash (**Fig. 3.8**).
5. When you return, turn the **Timer (A)** knob to the **Manual (D)** setting to return to manual cooking (**Fig. 3.8**).

TOP TIP

You can check how much time you have left, to the programmed stop time, by turning **Timer (A)** from **Auto (H)** to **Stop Time (G)** and back to **Auto (H)**.

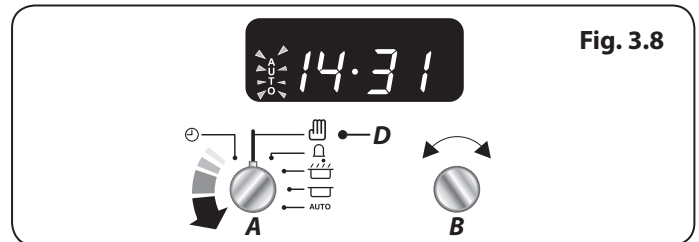
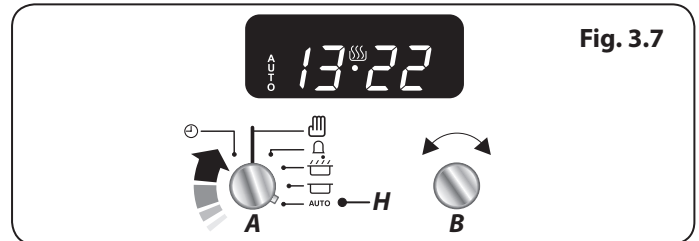
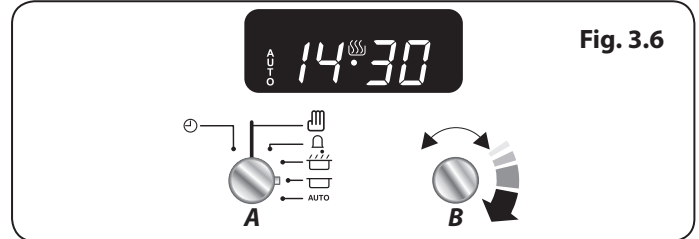
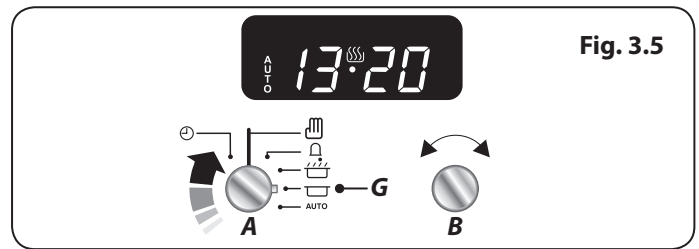

To start and stop the oven automatically

The timer allows you to automatically start and stop by a combination of the length of the cooking time and the stop time. Giving you the flexibility to cook casseroles etc while you are out. You cannot set the actual start time.

1. Turn the **Timer (A)** knob to the **Cook Time (F)** setting. Turn the **Adjusting (B)** knob clockwise to set the length of the cooking time required (**Fig. 3.9**).
2. Turn the **Timer (A)** knob to the **Stop Time (G)** setting (**Fig. 3.10**). The display will show the current time of day plus the 'cook time' you just set.
3. Turn the **Adjusting (B)** knob to set the time of day you want the oven to stop cooking (**Fig. 3.11**).
4. Set the oven to the required cooking temperature and function mode.
5. Turn the **Timer (A)** knob to the **Auto (H)** setting (**Fig. 3.12**). If the display shows the current time and the word 'AUTO' the oven is set to turn on and off.
6. When the program starts the oven, the cooking symbol will appear on the display. Once the specified time has elapsed it will emit an alarm and the Multifunction Oven will stop working. The 'Cooking' symbol on the display will disappear and the word 'AUTO' will flash (**Fig. 3.13**).
7. Once the specified time has elapsed it will emit an alarm. There are two ways to cancel the alarm, refer to **"Cancel the timer alarm" on page 16**
 - The 'cook period', which is the length of time you want the oven to cook for.
 - The 'stop time', which is the time of day you want the oven to stop cooking.

Reset to manual cooking

To cancel any automatic settings turn the **Timer (A)** knob to the **Manual (D)** setting and release (**Fig. 3.14**).

NOTE: Whilst this operation cancels all automatic program settings, it does not cancel the minute minder.

Beeper tone adjustment

The beeper tone can be adjusted to three different levels.

Turn the **Timer (A)** knob to the **Clock (C)** setting. Turn the **Adjusting (B)** knob counter clockwise until the tone bars are displayed (**Fig. 3.15**).

To adjust the tone of the alarm, release the **Adjusting (B)** knob and then turn counter clockwise again (**Fig. 3.16**). The tone of the alarm will change. Repeat these steps until the desired alarm tone is set.

Fig. 3.9

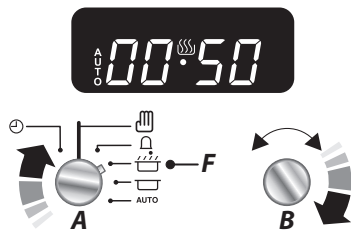

Fig. 3.10

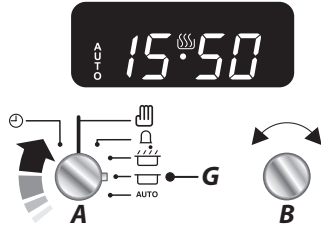

Fig. 3.11

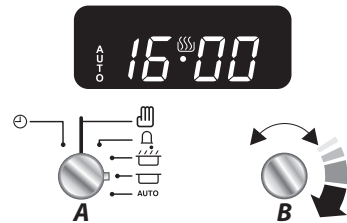

Fig. 3.12

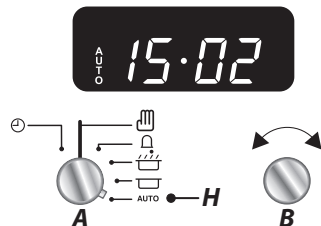

Fig. 3.13

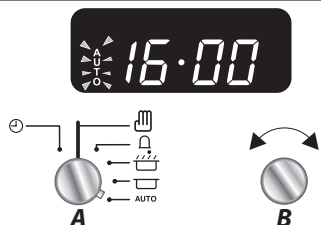

Fig. 3.14

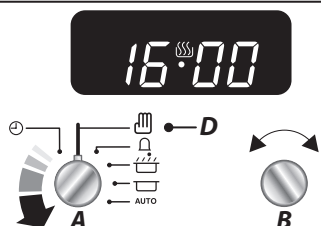

Fig. 3.15

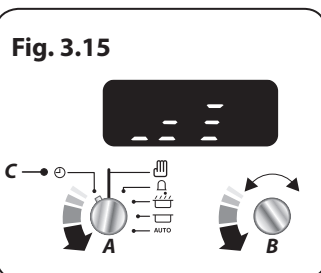
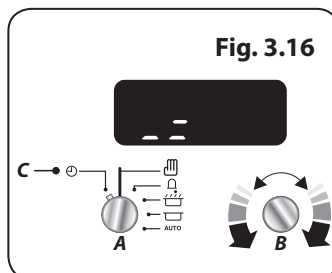

Fig. 3.16



4. 3 Button clock

Using the clock

You can use the clock to turn the programmable oven on and off. **The clock must be set to the time of day before the oven will work.**

NOTE: When using the timer functions, first set the clock as required before setting the oven temperature.

The oven can be switched on when the cook symbol [🔥] is displayed.

Setting the clock

1. The LCD clock is shown in **(Fig. 4.1)**. Once the cooker is connected and switched on, the display flashes (:00.00) and the time starts from (:00.00).
2. To set the clock press the [+] and [-] buttons simultaneously, the point between hours and minutes will start to flash for 5 seconds. Whilst the point is flashing press either the [+] or [-] button to set the correct time.

IMPORTANT: The timed oven will not operate unless the clock has been set.

Program selection - Setting the minute minder

The minute minder [🔔] provides the ability to set a countdown from 00:01h to 23:59h, at the end of which an alarm will sound.

1. Press the mode [M] button once **(Fig. 4.2)**. The bell symbol [🔔] will flash on the display. Select the desired countdown from 00:01h to 23:59h using the [+] button **(Fig. 4.3)**. The countdown will automatically begin and the [🔔] symbol will show in the display.
2. Once the specified time has elapsed an alarm will sound.
3. To stop the alarm press any button.

Re-set the minute minder

To re-set the minute minder, first select the minute minder program by pressing the mode [M] button. Then press the [+] and [-] buttons simultaneously.

- The 'cook period', which is the length of time you want the oven to cook for (dur).
- The 'stop time', which is the time of day you want the oven to stop cooking (End).

To stop the programmable oven at a specific time of day

1. Press the mode [M] button 3 times, until the display flashes 'End' **(Fig. 4.4)**.
2. Select the 'stop time' using the [+] or [-] buttons. The display will show the current time along with the 'AUTO' and Cooking [🔥] symbols **(Fig. 4.5)**.

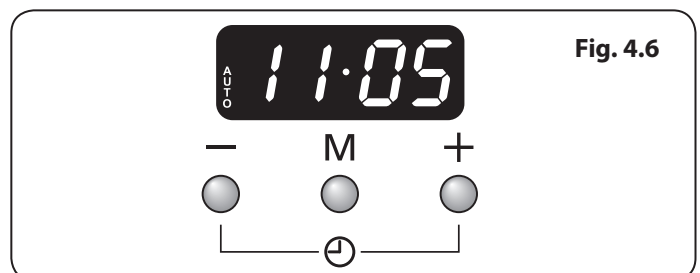
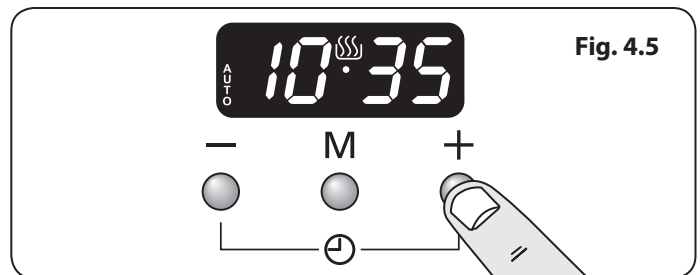
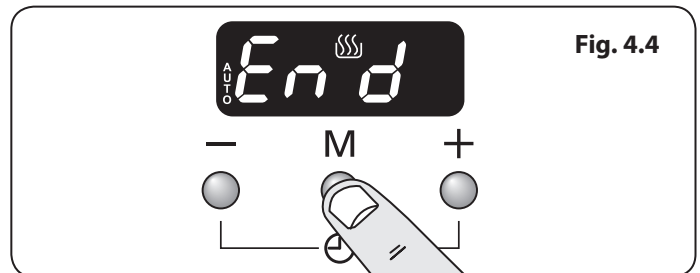
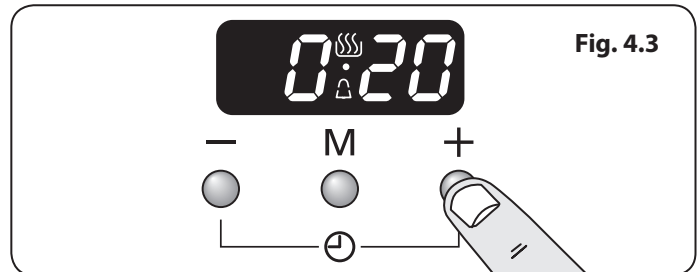
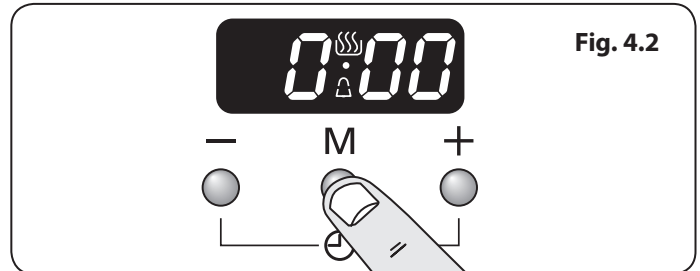
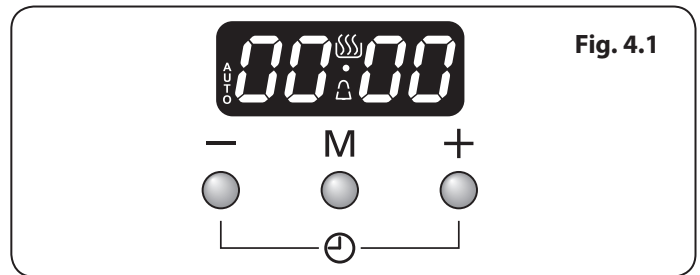

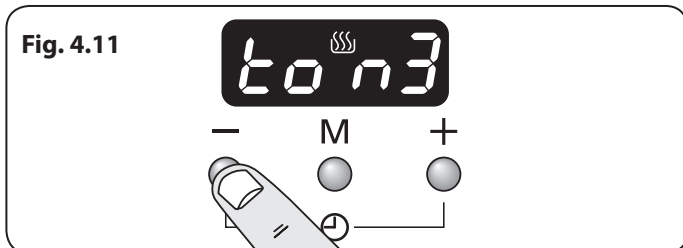
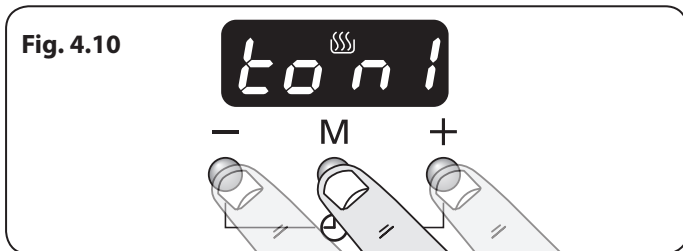
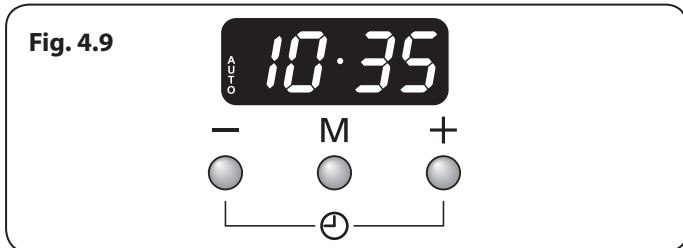
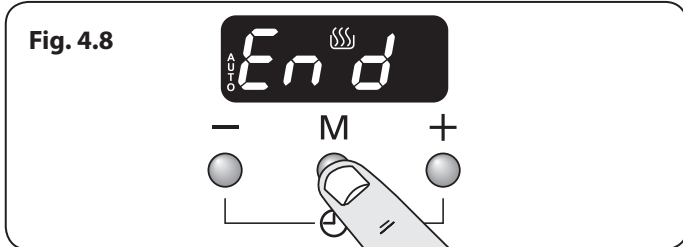
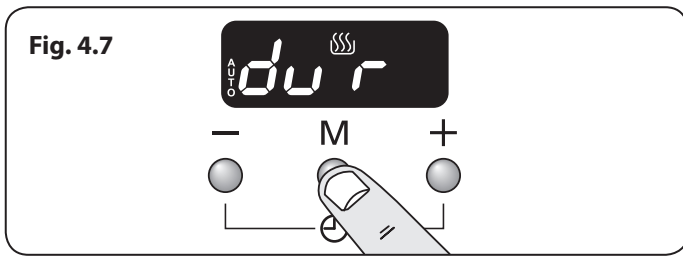

- When the 'stop time' is reached an alarm will sound and the oven will stop working. The word 'AUTO' will flash on the display (**Fig. 4.6**).
- Press any button to stop the alarm and return to manual cooking. If the alarm is not stopped, it will stop automatically after 7 minutes.

To start and then stop the programmable oven

Set the programmable oven to automatically start and stop using a combination of the 'cook period' and 'stop time'.

You cannot set a start time directly – this is set automatically by a combination of the 'cook period' and 'stop time'.

- Press the mode [M] button until the display flashes 'dur' (**Fig. 4.7**). Then set the 'cook period' using the [+] or [-] buttons.
- Press the mode [M] button until the display flashes 'End' (**Fig. 4.8**). Then set the 'stop time' using the [+] or [-] buttons. Current time will be displayed along with the word 'AUTO' (**Fig. 4.9**).
- Set the oven to the required cooking temperature.
- During the 'cook period' the cook symbol [☁] is illuminated in the display.
- When cooking is finished an alarm will sound. Press any button to stop the alarm and return to manual cooking. If the alarm is not stopped, it will stop automatically after 7 minutes.

AUTO is showing, but you want to revert to manual cooking

You can cancel any automatic settings by pressing the [+] and [-] buttons simultaneously.

Changing the frequency of the alarm

It is possible to change the alarm frequency.

- Press the the [+] and [-] buttons simultaneously, then the mode [M] button. The display will show 'ton1,2 or 3' (**Fig. 4.10**).
- To select the tone press the [-] button until desired tone is reached (**Fig. 4.11**).

3. 6 Button clock

Using the clock

You can use the timer (**Fig. 3.1**) to turn the oven(s) on and off. **The clock must be set to the time of day before the oven(s) will work.**

Table 3.1 describes the symbols shown on the digital display.

Setting the time of day

When the cooker is first connected to the mains, or if there has been a prolonged power interruption, the clock display flashes [0.00] and [AUTO].

During the time setting process the centre dot will flash. When the process is complete the dot will stop flashing and the [🍳] symbol will be displayed.

The time of day can be set in two ways:

- Press and hold the [🕒] button. Now press the [+] or [-] buttons to increase or decrease the time (**Fig. 3.2**). Holding the [+] or [-] buttons for more than 2 seconds will advance / decrease the set time quickly. Release the buttons to set the time of day.
- Press and hold both the [🍳] and [👤] buttons down (**Fig. 3.3**). Now press the [+] button (or [-] button) until the correct time shows.

DO NOT forget that it is a 24-hour clock.

If you need to reset the clock/cooker, turn off the power and wait several minutes, then start again.

Automatic dimming

Providing there are no automatic programs set, and the minute minder is not active, your clock will automatically dim during the hours between 22:00 and 06:00.

Minute minder

Press and hold the [🕒] button (**Fig. 3.4**), and then press the [+] button (or [-] button) until the length of time you want to cook for is shown (**Fig. 3.5**).

You can check the time remaining by pressing [🕒]. When the beeper sounds cancel it by pressing any button.

To reset the minute minder time; simultaneously press the [+] and [-] buttons.

NOTE: This will clear all automatic programs.

- The 'cook period', which is the length of time you want the oven to cook for.
- The 'stop time', which is the time of day you want the oven to stop cooking.

Setting a cook duration

Press and hold the [🍳] button and set the required 'cook period' by pressing the [+] button (or [-] button) (**Fig. 3.6**). The clock will now control the cook period of your oven(s). The [🍳] symbol and [AUTO] will be displayed.

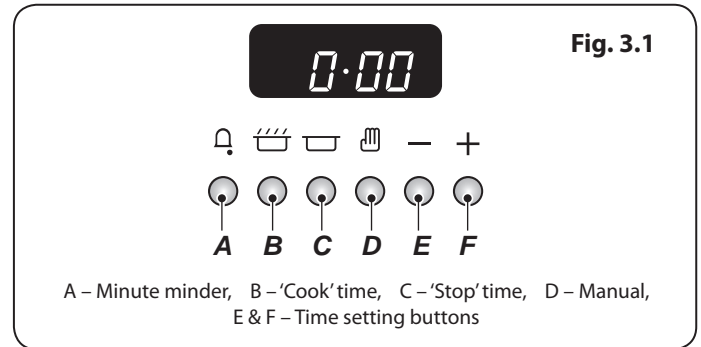

Symbol	Function	Notes
[🕒]	Minute Minder is active	
[🍳]	Oven(s) can be operated	If the 'cook' [🍳] symbol is not displayed the program has either ended and the oven(s) are non-operational the oven(s) are being controlled by an automatic program that has not started
[AUTO]	Oven(s) are being controlled in semi-automatic or automatic mode	
[P]	Self clean (pyrolytic) mode has been enabled	Your cooker may not have this pyrolytic function
[dot]	Flashes during setting the time of day	

Table 3.1

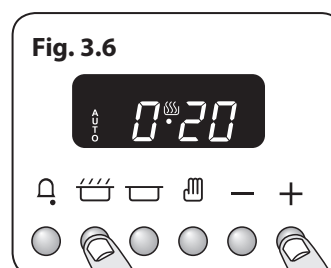
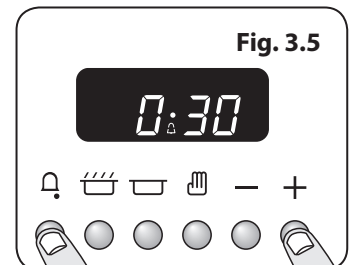
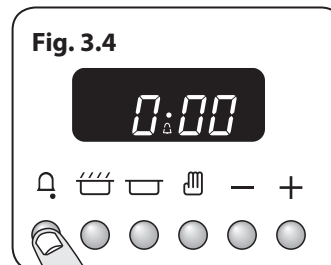
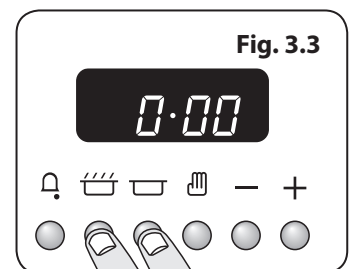
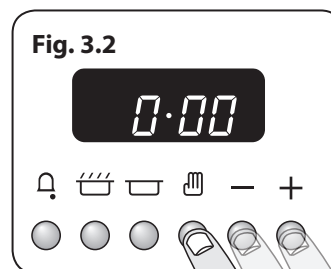

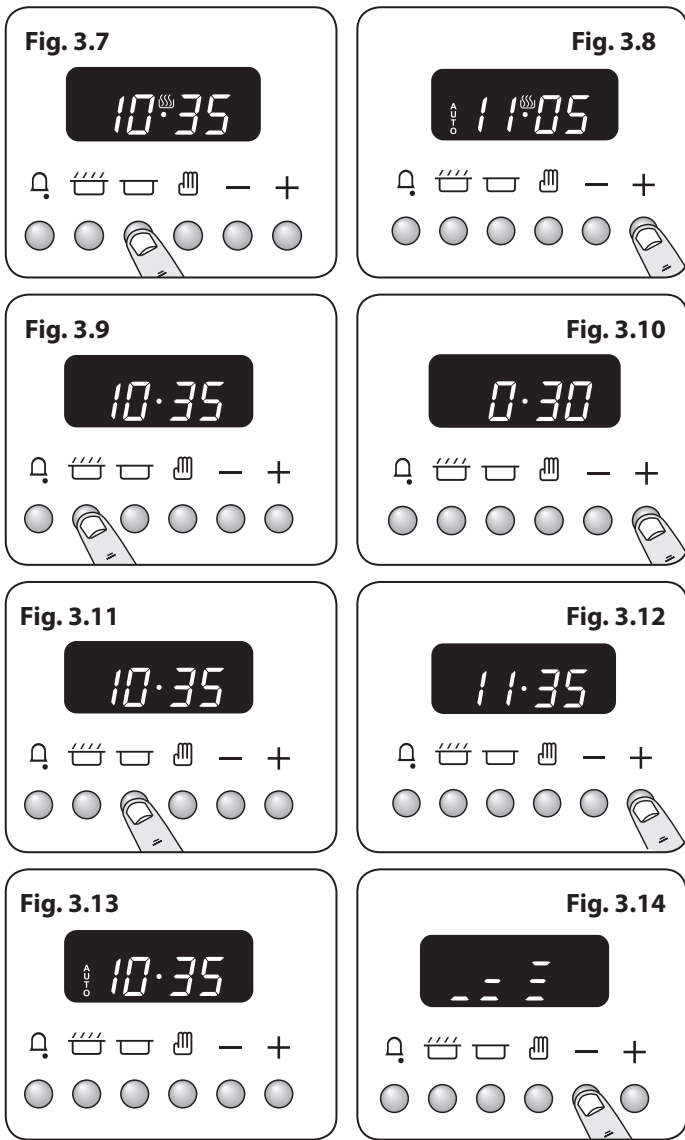

Symbol	Function	Notes
[🔔]	Sets the Minute Minder	Used with the [+] and [-] buttons
[🕒]	Sets the duration / cook period	Used with the [+] and [-] buttons
[🕒]	Sets the end / stop cook time	Used with the [+] and [-] buttons
[🕒] or [🕒]&[🕒]	Allows the time of day to be set when 'AUTO' is not active	Used with the [+] and [-] buttons
[🕒]	Resets the cooking control to manual	
[-]	Decreases time interval	Holding this button down allows a quick set
[+]	Increases time interval	Holding this button down allows a quick set
[+] & [-]	Clears all 'AUTO' and minute minder programs	

Table 3.2

Once the 'cook period' is reached, the beeper sounds and the [AUTO] symbol flashes. Turn the oven control knob to 0 and then press any button to stop the beep. Press [🕒] to return to manual cooking.

Setting a cook end time

Press and hold the 'stop time' [🕒] button (Fig. 3.7) and then press the [+] button (or [-] button) until the required 'stop time' shows (Fig. 3.8). The [🕒] symbol and [AUTO] will show in the display.

Once the 'stop time' is reached, the beeper sounds and the [AUTO] symbol flashes. Turn the oven control knob to 0 and then press any button to stop the beep. Press [🕒] to return to manual cooking.

To start and stop the ovens automatically

Before you set the clock for automatic operation you must have two numbers clearly in mind – the 'cook period' and the 'stop time'.

NOTE: You cannot set a start time directly – this is set automatically by setting the 'cook period' and the 'stop time'.

Press and hold the [🕒] button (Fig. 3.9) and then press the [+] button (or [-] button) until the required 'cook period' shows (Fig. 3.10).

Now press and hold the [🕒] button (Fig. 3.11) and then press the [+] button (or [-] button) until the required 'stop time' shows (Fig. 3.12). Release the buttons.

[AUTO] will now show in the display (Fig. 3.13).

Set the oven(s) to the required temperature. When cooking is finished [AUTO] will flash and the beeper will sound. Turn the oven knob(s) to the OFF position first, and then press any button once to stop the beep; press the [🕒] button to return to manual cooking.

If you are out, do not worry about the beeper going off, it stops after a while. When you return, turn the oven knob(s) to 0 first, and then press [🕒] to return to manual cooking.

AUTO is showing, you want to reset to manual cooking

To return to manual cooking mode from an Automatic setting, simultaneously press the [+] and [-] key, this will clear the automatic program and return to manual mode.

NOTE: This action will also clear the [Minute Minder] setting.

Beeper tone adjustment.

The beeper tone can be adjusted to three different levels.

Whilst in the time of day mode, press and hold the [-] button for a period until the display shows the Tone Bars (Fig. 3.14). Release the [-] button and immediately press again, this will adjust the tone down by a bar. Continue the process until a comfortable, tone is reached.

NOTE: During a power reset the clock will remember the last tone set.



For an overview of the functions refer to **Table 3.2**.

5. Cooking Tips

Tips on cooking with the timer

If you want to cook more than one dish, choose dishes that require approximately the same cooking time. However, dishes can be 'slowed down' slightly by using small containers and covering them with aluminium foil, or 'speeded up' slightly by cooking smaller quantities or placing them in larger containers.

Very perishable foods such as pork or fish should be avoided if a long delay period is planned, especially in hot weather.

-  **DO NOT place warm food in the oven to be timed.**
-  **DO NOT use a timed oven that is already warm.**
-  **DO NOT use the timed oven if the adjoining oven is already warm.**

Whole poultry must be thoroughly defrosted before being placed in the oven. Check that meat and poultry are fully cooked before serving.

General oven tips

The wire shelves should always be pushed firmly to the back of the oven.

Baking trays with food cooking on them should be placed level with the front edge of the oven's wire shelves. Other containers should be placed centrally. Keep all trays and containers away from the back of the oven, as overbrowning of the food may occur.

For even browning, the maximum recommended size of a baking tray are:

- depth: 340 mm (13 3/8") by width: 340 mm (13 3/8") in the main oven

When the oven is on, DO NOT leave the door open for longer than necessary, otherwise the knobs may get very hot.

- Always leave a "finger's width" between dishes on the same shelf. This allows the heat to circulate freely around them.
- To reduce fat splashing when you add vegetables to hot fat around a roast, dry them thoroughly or brush lightly with cooking oil.
- Where dishes may boil and spill over during cooking, place them on a baking tray.
- The 'Cook & Clean' oven liners (see 'Cleaning Your Cooker') work better when fat splashes are avoided. Cover meat when cooking.
- Sufficient heat rises out of the oven while cooking to warm plates in the grill compartment.
- If you want to brown the base of a pastry dish, preheat the baking tray for 15 minutes before placing the dish in the centre of the tray.

4. Cooking Table

The oven control settings and cooking times given in the table below are intended to be used **as a guide only**. Individual tastes may require the temperature to be altered to provide a preferred result.

Food is cooked at lower temperature in a fan oven than in a conventional oven. When using recipes, reduce the fan oven temperature by 10°C and the cooking time by 5-10 minutes. The temperature in the fan oven does not vary with height in the oven so you can use any shelf.

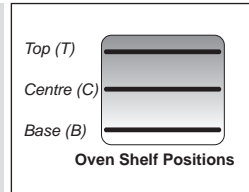

Food	Conventional Oven °C (Shelf Position)	Fan Oven Temperature	Approximate Cooking Time	
Meat				
Beef (no bone)	160 (C)	150 °C	30-35 minutes per 500g +30-35 minutes.	Thoroughly thaw frozen joints before cooking. Meat may be roasted at 220°C (210°C for fan oven) and the cooking time adjusted accordingly. For stuffed and rolled meats, add approximately 10 minutes per 500g, or cook at 200°C (190°C) for 20 minutes then 160°C (150°C) for the remainder.
	200 (C)	190 °C	20-25 minutes per 500g +20-25 minutes.	
Lamb	160 (C)	150 °C	30-35 minutes per 500g +30-35 minutes.	
	200 (C)	190 °C	25-30 minutes per 500g +25-30 minutes.	
Pork	160 (C)	150 °C	35-40 minutes per 500g +35-40 minutes.	
	200 (C)	190 °C	25-30 minutes per 500g +25-30 minutes.	
Poultry				
Chicken	160 (C)	150 °C	20-25 minutes per 500g +20-25 minutes.	For stuffed poultry, you could cook at 200°C (190°C) for 20 minutes then 160°C (150°C) for remainder. Do not forget to include the weight of the stuffing.
	200 (C)	190 °C	15-20 minutes per 500g +15-20 minutes.	
Turkey	160 (C)	150 °C	20 minutes per 500g +20 minutes.	
	200 (C)	190 °C	15 minutes per 500g +15 minutes.	
Duck	160 (C)	150 °C	25-30 minutes per 500g.	For fresh or frozen prepacked poultry, follow instructions on the pack. Thoroughly thaw frozen poultry before cooking.
	200 (C)	190 °C	20 minutes per 500g.	
Casserole	140-150 (C)	130 °C-140 °C	2-4 hours according to recipe.	
Yorkshire Pudding	220 (C)	210 °C	Large tins 30-35 minutes; individual 10-20 minutes.	
Cake				
Very rich fruit - Christmas, wedding, etc.	140 (C/B)	130 °C	45-50 minutes per 500g of mixture.	Using the conventional oven: when two tier cooking leave at least one runner space between shelves.
Fruit 180 mm tin	150 (C/B)	140 °C	2-2½ hours.	
Fruit 230 mm tin	150 (C/B)	140 °C	Up to 3½ hours.	
Madeira 180 mm	160 (C/B)	150 °C	80-90 minutes.	Position the baking tray with the front edge along the front of the oven shelf.
Queen cakes	190 (C/B)	180 °C	15-25 minutes.	
Scones	220 (C/B)	210 °C	10-15 minutes.	
Victoria sandwich				
180 mm tin	180 (C/B)	170 °C	20-30 minutes.	
210 mm tin	180 (C/B)	170 °C	30-40 minutes.	
Desserts				
Shortcrust tarts	200 (C/B)	190 °C	20-30 minutes on a preheated tray.	Up to three tiers can be cooked in a fan oven at the same time but make sure to leave at least one runner space between each shelf being cooked on.
Fruit pies	200 (C/B)	190 °C	35-45 minutes.	
Tartlets	200 (C/B)	190 °C	10-20 minutes according to size.	
Puff pastry	210 (C/B)	200 °C	20-40 minutes according to size.	
Meringues	100 (C/B)	90 °C	2-3 hours.	Up to three tiers can be cooked in a fan oven at the same time but make sure to leave at least one runner space between each shelf being cooked on.
Baked egg custard	160 (C/B)	150 °C	45-60 minutes.	
Baked sponge pudding	180 (C/B)	170 °C	40-45 minutes.	
Milk pudding	140-150 (C/B)	130 °C-140 °C	2 to 3 hours.	
Bread	210 (C)	200 °C	20-30 minutes.	
Fish				
	Fanned Grilling			
Fillet	190 (C/B)	190 °C (C/B)	15-20 minutes	
Whole	190 (C/B)	190 °C (C/B)	15-20 minutes per 500g.	
Steak	190 (C/B)	190 °C (C/B)	Steaks according to thickness.	

7. Cleaning your cooker

Essential information

Isolate the electricity supply before carrying out any thorough cleaning. Allow the cooker to cool.

⚠ NEVER use paint solvents, washing soda, caustic cleaners, biological powders, bleach, chlorine based bleach cleaners, coarse abrasives or salt.

⚠ DO NOT mix different cleaning products – they may react together with hazardous results.

All parts of the cooker can be cleaned with hot soapy water – **but take care that no surplus water seeps into the appliance.**

Remember to switch on the electricity supply and reset the clock before re-using the cooker.

Hotplate burners

Some models have a separate trim ring, which fits on the burner head.

The burner heads and caps can be removed for cleaning.

⚠ DO NOT put the burner heads in a dishwasher.

Make sure they are absolutely dry before replacing them.

The Single Ring Burners

When refitting the burner head, make sure that the notch lines up with the electrode or hole in the base. Check that the burner head is level and that the cap is fitted centrally on the burner head (**Fig. 7.1**).

The Wok Burner

The Wok burner can also be taken apart for cleaning.

When reassembling the wok burner (**Fig. 7.2**), turn over the large base ring and find the 'D' shaped area (**Fig. 7.3**). Turn the head until the 'D' matches the one on the burner base. Flip the burner over once again and place it on the burner base.

To fit the small inner burner, find the larger electrode notch in the burner rim. Line this up with the white ignition electrode and place the inner burner on the large base ring (**Fig. 7.4**).

Now fit the two burner caps, ensuring that they are seated properly.

Check the burner ports are not blocked. If a blockage occurs, remove stubborn particles using a piece of fuse wire.

The Wok Cradle

Recommended cleaning materials are hot soapy water, a moistened soap pad, cream cleaner or a nylon scourer.

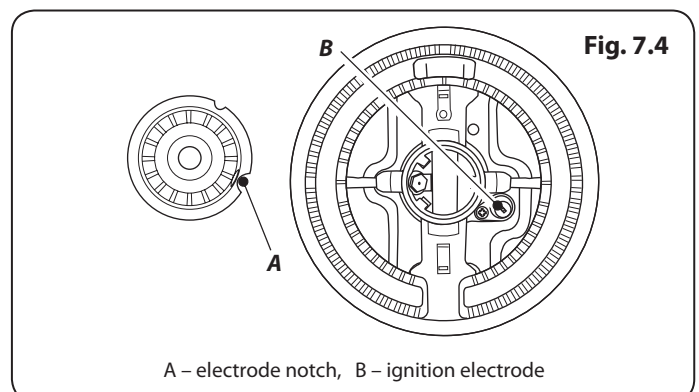
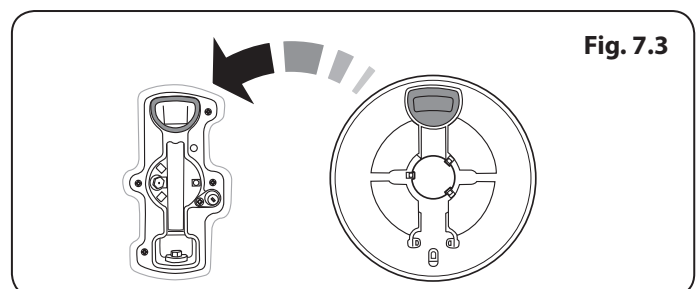
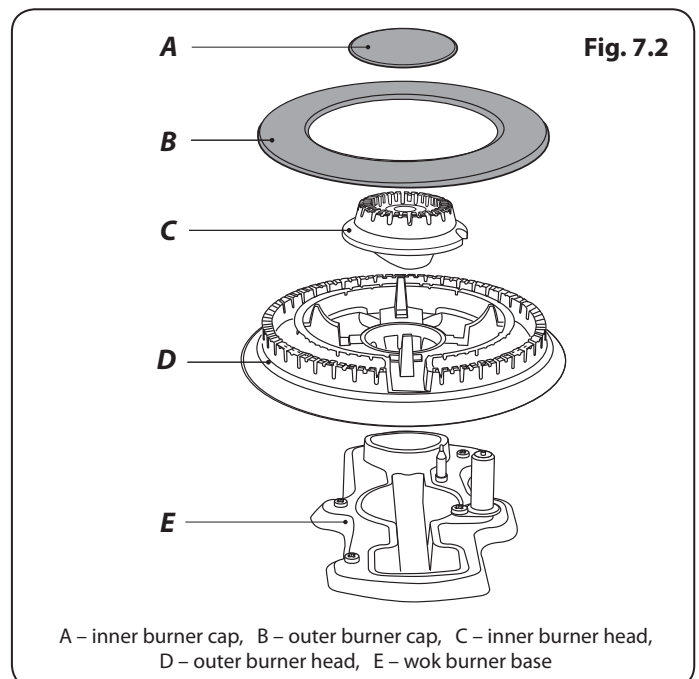
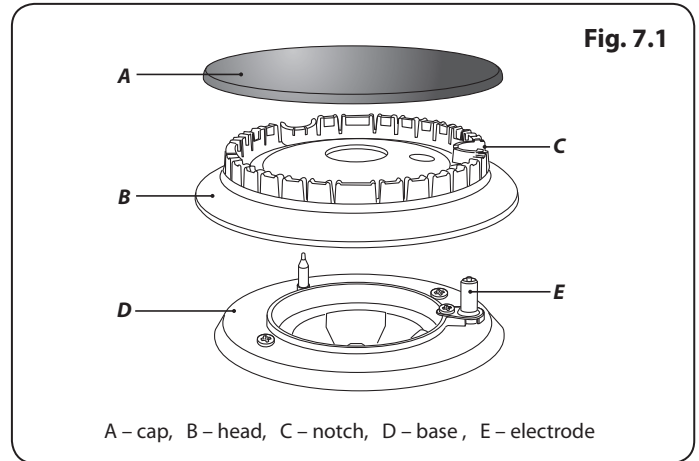

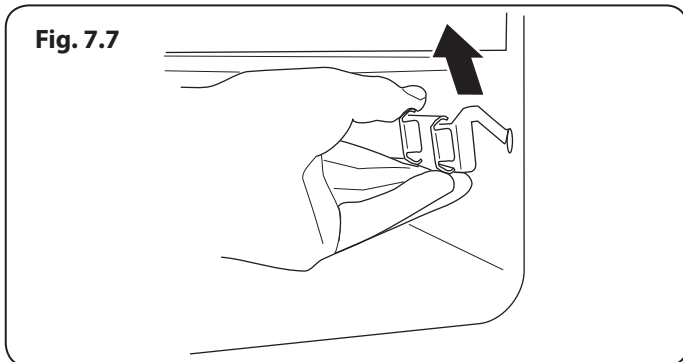
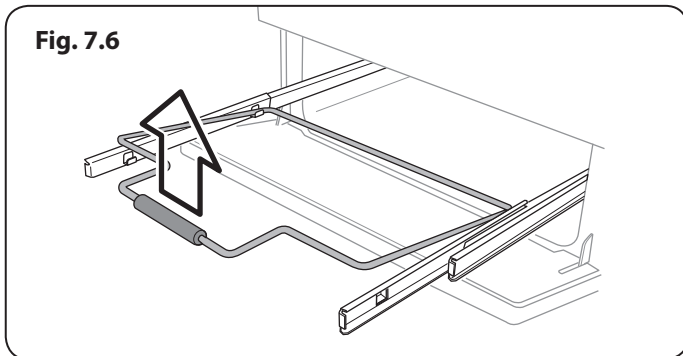
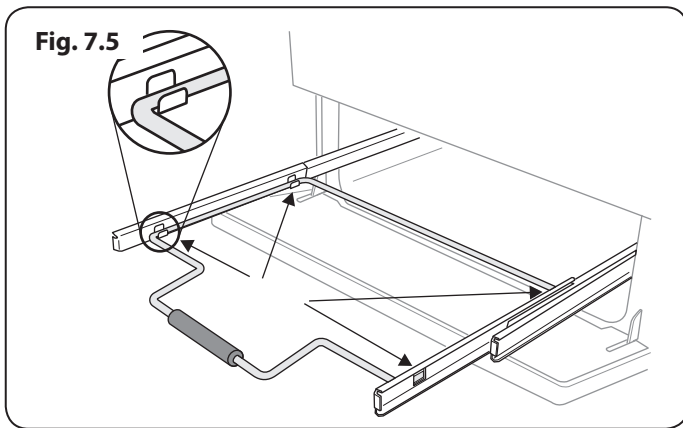

The Griddle

Always clean the griddle after use. Allow it to cool completely before removing. Immerse the griddle plate in hot soapy water. Use a soft cloth or, for stubborn stains, a nylon washing up brush.

NOTE: If the griddle is washed in a dishwasher then some dishwasher residue may appear on the back. This is normal and will not affect the performance of your griddle.

Glide-out Grill

The grill pan and trivet should be washed in hot soapy water. Alternatively, the grill pan can be washed in a dishwasher.

After grilling meats or any foods that soil, leave to soak for a few minutes in the sink immediately after use. Stubborn particles may be removed from the trivet using a nylon brush.

⚠ Before you remove any of the grill parts for cleaning, make sure that they are cool, or use oven gloves.

⚠ DO NOT use any abrasive substances.

Cleaning the Glide-out Grill

The grill pan can be easily removed for cleaning as follows:

Remove the grill pan support frame by pulling the grill pan forward.

Lift the grill pan clear of the support frame. The support frame is held to the side rails by two clips on each side (**Fig. 7.5**).

For each side, support the side rail with one hand and with the other hand lift the frame up and out of the side clips (**Fig. 7.5**).

For safety, push the side rails back into the grill chamber.

If you need to remove the side rails to allow cleaning of the grill chamber, you can unhook them from the grill chamber sides (**Fig. 7.6**) and wipe the sides clean with a soft cloth and mild detergent.

⚠ DO NOT put the side runners in a dishwasher.

Once you have finished, hook the side rails back onto the sides of the chamber. To refit the frame, pull the side rails forward and, for each side in turn, support the side rail and press the frame down into the side rails. Replace the grill pan

Control panel and doors

Avoid using any abrasive cleaners including cream cleaners, on brushed stainless steel surfaces. For best results, use a liquid detergent.

The control panel, knobs and doors should only be cleaned with a soft cloth wrung out in clean hot soapy water – but take care that no surplus water seeps into the appliance.

After cleaning, polish with a dry cloth.

Glass fronted door panels

The oven door front panels can be taken off so that the glass panels can be cleaned. Move the cooker forward to gain access to the sides (see the 'Moving the Cooker' section under 'Installation').

Open the oven door slightly and remove the front panel fixing screws from the door sides, two each side (Fig. 7.8).

Carefully lift off the outer door panel. The inside face of the glass panels can now be cleaned – take care not to disturb or wet the door insulation.

NOTE: If the door is triple glazed then the inner two panels are fixed together and should not be separated.

After cleaning, carefully refit the outer door panel and replace the side fixing screws.

⚠ DO NOT use harsh abrasive cleaners or sharp metal scrapers to clean the oven door glass since they can scratch the surface, which may result in shattering of the glass.

Ovens

'Cook & Clean' Panels

The main oven has panels which have been coated with a special enamel that partly cleans itself. This does not stop all marks on the lining, but helps to reduce the amount of manual cleaning needed.

The Cook & Clean panels work better above 200 °C. If you do most of your cooking below this temperature, occasionally remove the panels and wipe with a lint free cloth and hot soapy water. The panels should then be dried and replaced and the oven heated at 200 °C for about one hour. This will make sure that the Cook & Clean panels are working effectively.

⚠ DO NOT use steel wool, oven cleaning pads, or any other materials that will scratch the surface.

Removing the main oven linings

Some of the lining panels can be removed for cleaning.

If you wish to clean the enamel interior of the oven, you will need to remove the shelves before removing the 'Cook & Clean' panels. You do not have to remove the support brackets to remove the panels. Lift each panel upward and slide forward off the support brackets (Fig. 7.9).

Once the panels have been removed, the oven enamel interior can be cleaned.

Refit in the reverse order.

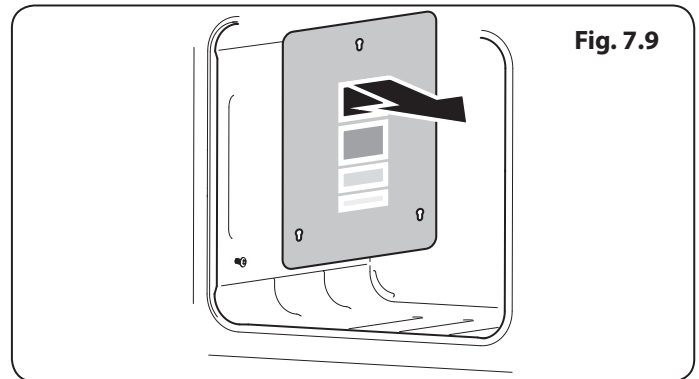
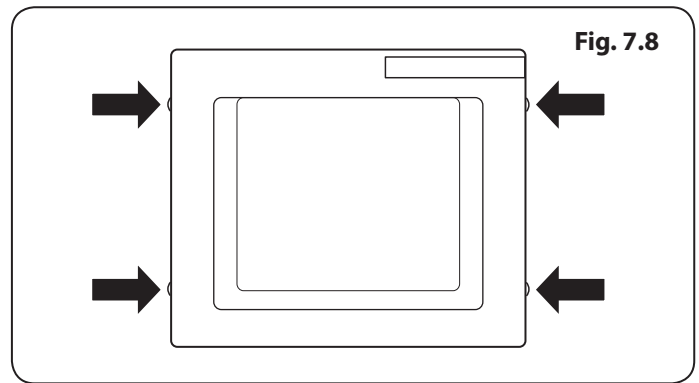

Cleaning table

Cleaners listed are available from supermarkets or electrical retailers as stated.

For enamelled surfaces use a cleaner that is approved for use on vitreous enamel.

Regular cleaning is recommended. For easier cleaning, wipe up any spillages immediately.

Hotplate		
Part	Finish	Recommended Cleaning Method
Hob top (including burner heads and caps)	Enamel, stainless steel, aluminium	Hot soapy water, soft cloth. Any stubborn stains remove gently with a nylon scourer.
Ceramic/Induction hob	Toughened glass	Hot soapy water; cream cleaner/scourer if necessary.
Griddle plate (some models only)	Non-stick surface	Allow to cool. Wash in hot soapy water. Do not use abrasive cleaners/scourers. Dishwasher.
Warming zone (some models only)	Toughened glass	Hot soapy water, cream cleaner/scourer if necessary.
Outside of Cooker		
Part	Finish	Recommended Cleaning Method
Door, door surround and storage drawer exterior	Enamel or paint	Hot soapy water, soft cloth. Any stubborn stains, remove gently with a liquid detergent.
	Stainless steel	E-cloth (electrical retailers) or microfibre all-purpose cloth (supermarket).
Sides and plinth	Painted surface	Hot soapy water, soft cloth.
Splashback/rear grille	Enamel or stainless steel	Hot soapy water, soft cloth. Cream cleaner, with care, if necessary.
Control panel	Paint, enamel or stainless steel	Warm soapy water. Do not use abrasive cleaners on lettering.
Control knobs/handles & trims	Plastic/chrome, copper or lacquered brass	Warm soapy water, soft cloth.
	Brass	Brass polish.
Oven door glass/glass lid	Toughened glass	Hot soapy water, cream cleaner/scourer if necessary.
Oven and Grill		
Part	Finish	Recommended Cleaning Method
Sides, floor & roof of oven NOT COOK & CLEAN OVEN PANELS (see below)	Enamel	Any proprietary oven cleaner that is suitable for enamel. CAUTION: CORROSIVE/CAUSTIC OVEN CLEANERS: FOLLOW MANUFACTURER'S INSTRUCTIONS. Do not allow contact with the oven elements.
Cook & Clean oven panels (some models only)	Special enamel that partly cleans itself	This surface cleans itself at 200 °C and above, or the panels can be removed and washed with hot soapy water and a nylon brush (see 'The Ovens' in 'Cleaning your Cooker').
Oven shelves, Handyrack, Grill trivet, Handygrill rack	Chrome	An oven interior cleaner that is suitable for chrome. Soap filled pad. Dishwasher.
Grill pan/meat tin (some models only)	Enamel	Hot soapy water. Soap filled pad. Dishwasher.

9. Troubleshooting

Hotplate/Cooktop ignition or hotplate burners faulty

Is the power on? Is the clock illuminated?

If not, there maybe something wrong with the power supply.

Are the sparker (ignition electrode) or burner slots blocked by debris?

Are the burner trim and caps correctly located? See the section on 'Cleaning'.

Hotplate/Cooktop burners will not light

Make sure that the burner parts have been replaced correctly after wiping or removing for cleaning.

Check that there is not a problem with your gas supply. You can do this by making sure that other gas appliances you may have are working.

Do the burners spark when you push in the knob or button?

If not, verify that the power is on by checking that the clock is illuminated.

Steam is coming from the oven

When cooking foods with high water content (e.g. oven fries) there may be some steam visible at the rear grille.

Take care when opening the oven door, as there may be a momentary puff of steam when the oven door is opened. Stand well back and allow any steam to disperse.

What cleaning materials are recommended for the cooker?

See the 'Cleaning' section for recommended cleaning materials.

⚠ Never use caustic or abrasive cleaners as these will damage the surface.

An oven fan is noisy

The note of the oven fan may change as the oven heats up – this is perfectly normal.

If there is an installation problem and I don't get my original installer to come back to fix it who pays?

You do. Service organizations will charge for their call outs if they are correcting work carried out by your original installer. It is in your interest to track down your original installer.

Power failure

In the event of a failure in the electrical supply, remember to reset the clock to make sure that the timed oven continues to operate.

Food is cooking too slowly, too quickly, or burning

Cooking times may differ from your previous oven.

Check that you are using the recommended temperatures and shelf positions – see the oven cooking guide. The oven control settings and cooking times are intended to be used only as a guide.

Individual tastes may require the temperature to be altered either way, to get the results you want.

The oven is not cooking evenly

DO NOT use a baking tray with dimensions larger than those specified in the section on 'General Oven Tips'.

If you are cooking a large item, be prepared to turn it round during cooking.

If two shelves are used, check that space has been left for the heat to circulate. When a baking tray is put into the oven, make sure that it is placed centrally on the shelf.

Check that the door seal is not damaged and that the door catch is adjusted so that the door is held firmly against the seal.

A dish of water when placed on the shelf should be the same depth all over. (For example, if it is deeper at the back, then the back of the cooker should be raised up or the front lowered.) If the cooker is not level, arrange for your supplier to level it for you.

Oven not coming on

Is the power on? Is the clock illuminated? If not, there may be something wrong with the power supply.

Is the cooker supply on at the isolator switch?

Has the time of day been set?

The timed oven is not coming on when automatic cooking

Has the oven knob been left in the OFF position by mistake?

Oven temperature getting hotter as the cooker gets older

If turning the temperature down using the oven control knob has not worked, or has only worked for a short time, then you may need a new thermostat. This should be fitted by a qualified service person.

Fig. 9.1

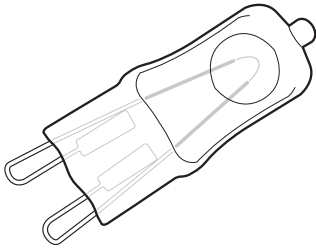

Oven light is not working

The bulb has probably burnt out. You can buy a replacement bulb (which is not covered under the warranty) from a good electrical shop. Ask for a 40W – 230V halogen lamp (G9) (**Fig. 9.1**).

Turn off the power at the circuit breaker.

Before removing the existing bulb, turn off the power supply and make sure that the oven is cool. Open the oven door and remove the oven shelves.

Unscrew the bulb cover by turning counter-clockwise. It may be very stiff (**Fig. 9.2**).

Pull the existing bulb to remove it. When handling the replacement bulb, avoid touching the glass with your fingers, as oils from your hands can cause premature failure. Push, click in the replacement bulb.

Replace the bulb cover by turning it a quarter turn, clockwise. Turn on the circuit breaker and check that the bulb now lights.

Fig. 9.2

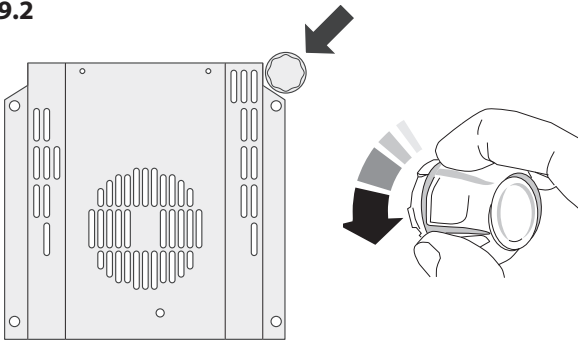

The oven door is misaligned

The bottom hinge of either oven door can be adjusted to alter the angle of the door (**Fig. 9.3**). Loosen the bottom hinge fixing screws and use the notch and a flat bladed screwdriver to move the position of the hinge to set the hinge position (**Fig. 9.4**).

Retighten the hinge screws.

Fig. 9.3

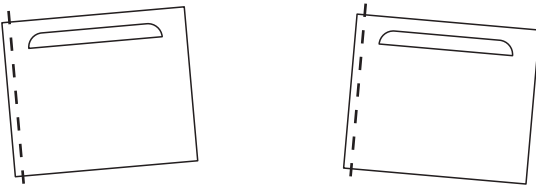

Effect of hinge adjustment – exaggerated for clarity

Grill

The fascia gets hot when I use the oven or grill

The cooker is cooled by a fan. If the fascia becomes excessively hot when the cooker is in use then the cooling fan may have failed. Should this occur please contact your installer, a qualified repair engineer or Customer Service to arrange for its repair.

The knobs get hot when I use the oven or the grill. Can I avoid this?

Yes, this is caused by heat rising from the oven or the grill, and heating them up. **DO NOT** leave the oven door open.

Make sure that the grill pan is pushed right back to the 'back stop' when grilling.

Always grill with the grill compartment door open.

Grill is not cooking properly

Are you using the pan and trivet supplied with the cooker?

Is the pan being used on the runners, not the floor of the grill compartment?

Is the grill tray pushed back fully to the stop?

Fig. 9.4

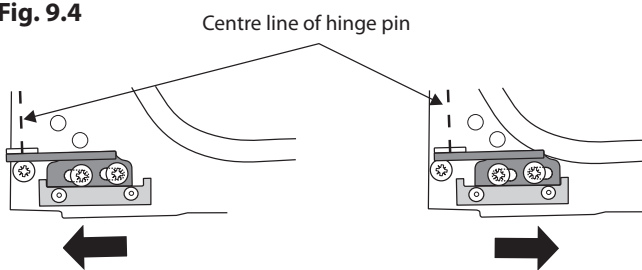

Oven door omitted for clarity

INSTALLATION

Check the appliance is electrically safe and gas sound when you have finished.







10. Installation

Dear Installer

Before you start your installation, please complete the details below, so that, if your customer has a problem relating to your installation, they will be able to contact you easily.

Installer's Name
Installer's Company
Installer's Telephone Number
Appliance Serial Number

Safety Requirements and Regulations

-  **This cooker must be installed in accordance with the relevant instructions in this booklet, with the relevant national and local regulations, and with the local gas and electricity supply companies' requirements.**
-  **This cooker is a Class 2 Subclass 1 appliance.**
-  **Before installation, make sure that the cooker is suitable for your gas type and supply voltage. See the data badge.**
-  **The appliance must be installed in accordance with the regulations in force and only in a well ventilated space.**
-  **Read the instructions before installing or using this appliance.**
-  **In your own interest and that of safety, it is law that all gas appliances be installed by competent persons. Failure to install the appliance correctly could invalidate any warranty or liability claims and lead to prosecution.**
-  **This appliance can be converted for use on another gas.**

In the UK the cooker must be installed in accordance with:

- All relevant British Standards / Codes of Practice, in particular BS 5440 Part 2.
- For Natural Gas – BS 6172 and BS 6891.
- For LP Gas – BS 5482-1 (when the installation is in a permanent dwelling), BS 5482-2 (when the installation is in a caravan or other non-permanent dwelling), or BS 5482-3 (when the installation is in a boat).
- The Gas Safety (Installation and Use) regulations.
- The relevant Building / IET regulations.

In the Republic of Ireland the cooker must be installed in accordance with:

The installation must be carried out by a competent person and installed in accordance with the current edition of IS 813 "Domestic Gas Installations", the current Building Regulations and reference should be made to the current ETCl rules for electrical installation.

Provision of Ventilation

This appliance is not connected to a combustion products evacuation device. Particular attention shall be given to the relevant requirements regarding ventilation.

All rooms require a window that can be opened, or equivalent, while some rooms require a permanent vent in addition to the window.

In the UK:

The room containing the cooker should have an air supply in accordance with BS 5440 Part 2. All rooms require an openable window or equivalent, while some rooms require a permanent vent in addition to the openable window. The cooker should not be installed in a bedsitting room with volume less than 20 m³. If it is installed in a room of volume less than 5 m³ an air vent of effective area 100 cm² is required; if it is installed in a room of volume between 5 m³ and 10 m³, an air vent of effective area 50 cm² is required; while if the volume exceeds 11 m³, no air vent is required.

If there are other fuel burning appliances in the same room, BS 5440 Part 2 should be consulted to determine the requisite air vent requirements.

In the Republic of Ireland:

Reference should be made to the current edition of IS 813, which makes clear the conditions that must be met to demonstrate that sufficient ventilation is available.

INSTALLATION

Check the appliance is electrically safe and gas sound when you have finished.

Checking the parts:

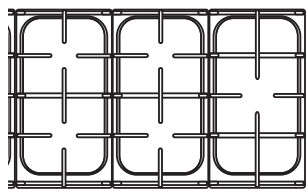
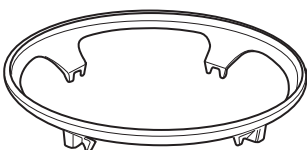
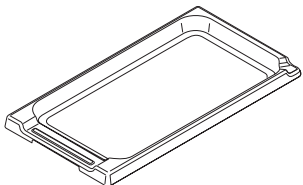
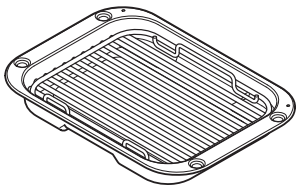
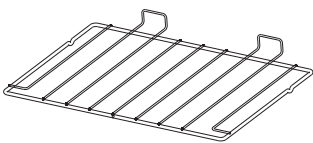
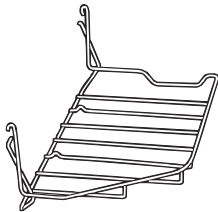
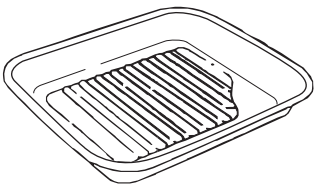
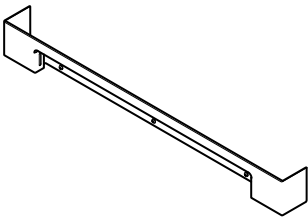
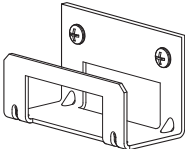
3 pan supports	Wok cradle
	
Griddle	Grill pan and trivet
	
Flat shelves	Handyrack
	
Roasting tin	Plinth
	
Stability location bracket	
	

Location of Cooker

The cooker may be installed in a kitchen/kitchen diner but NOT in a room containing a bath or shower.

This appliance is designed for domestic cooking only. Use for any other purpose could invalidate any warranty or liability claim.

Note: An appliance for use on LPG must not be installed in a room or internal space below ground level, e.g. in a basement.

Conversion

This appliance is supplied set for G20 20 mbar Cat II_{2H3+}.

A conversion kit for another gas is available for the cooker.

If the appliance is to be converted to another gas we recommend that this is carried out before installation.

After converting the appliance, please attach the Gas Conversion sticker over the appropriate area of the data badge – this will identify the gas type for which the appliance is now set.

You will need the following equipment to complete the cooker installation satisfactorily:

- Stability bracket: If the cooker is to be supplied with gas through a flexible hose, a stability bracket or chain must be fitted. **These are not supplied with the cooker but are available at most builders' merchants.**
- Gas pressure tester/manometer.
- Flexible gas hose: Must be in accordance with the relevant standards.
- Multimeter: For electrical checks.

You will also need the following tools:

1. Electric drill
2. Masonry drill bit (only required if fitting the cooker on a stone or concrete floor)
3. Wall plugs (only required if fitting the cooker on a stone or concrete floor)
4. Steel tape measure
5. Cross head screwdriver
6. Flat head screwdriver
7. Spirit level
8. Pencil
9. Adjustable spanner
10. Screws for fitting stability bracket
11. 13 mm spanner or socket wrench

INSTALLATION

Check the appliance is electrically safe and gas sound when you have finished.

Positioning the Cooker

Fig. 10.1 and **Fig. 10.2** shows the minimum recommended distance from the cooker to nearby surfaces.

The cooker should not be placed on a base.

Fig. 10.1 and **Fig. 10.2** Cookers installed into recess: The cooker must have side clearance **ABOVE** hob level of 75mm up to a height of 410mm. This can be reduced to 25mm if the surface is made from a non-combustible material.

A minimum space of 650 mm is required between the top of the hob and a horizontal combustible surface.

*Any cookerhood should be installed in accordance with the hood manufacturer's instructions.

**Any splashback must be fitted in accordance with the manufacturers instructions. Allowance should be made for the additional height of the flue trim, which is fitted to the cooker hob.

Surfaces of furniture and walls at the sides and rear of the appliance should be heat, splash and steam resistant. Certain types of vinyl or laminate kitchen furniture are particularly prone to heat damage and discolouration. We cannot accept responsibility for damage caused by normal use of the cooker to any material that de-laminates or discolours at temperatures less than 65°C above room temperature.

DO NOT box the cooker in – it must be possible to move the cooker in and out for cleaning and servicing.

To allow the oven doors to open, a clearance of 130 mm is required if the cooker is near a corner of the kitchen (**Fig. 10.3**). The actual opening of the doors is slightly less, but this allows for some protection of your hand as you open the door.

Moving the Cooker

⚠ On no account try and move the cooker while it is plugged into the electricity supply.

⚠ The cooker is very heavy, so take great care.

We recommend that two people manoeuvre the cooker. Make sure that the floor covering is firmly fixed, or removed, to prevent it being disturbed when moving the cooker around.

To help you, there are two levelling rollers at the back, and two screw-down levelling feet at the front.

Remove the polystyrene base pack. From the front, tilt the cooker backwards and remove the front half of the polystyrene base (**Fig. 10.4**).

Repeat from the back and remove the rear half of the polystyrene base.

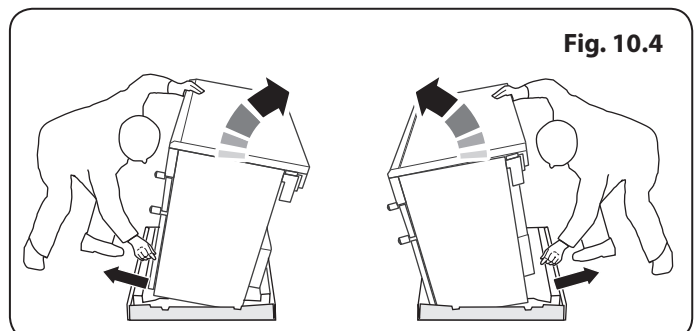
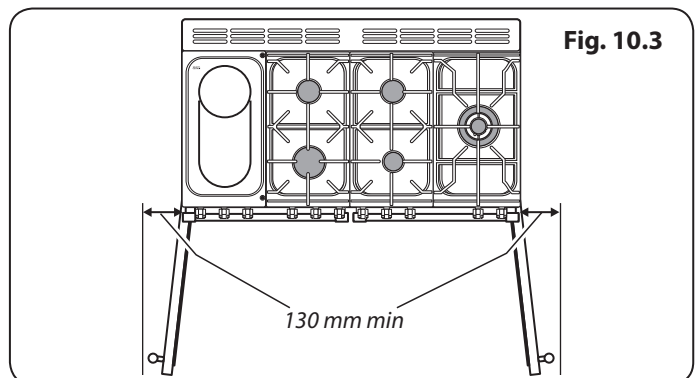
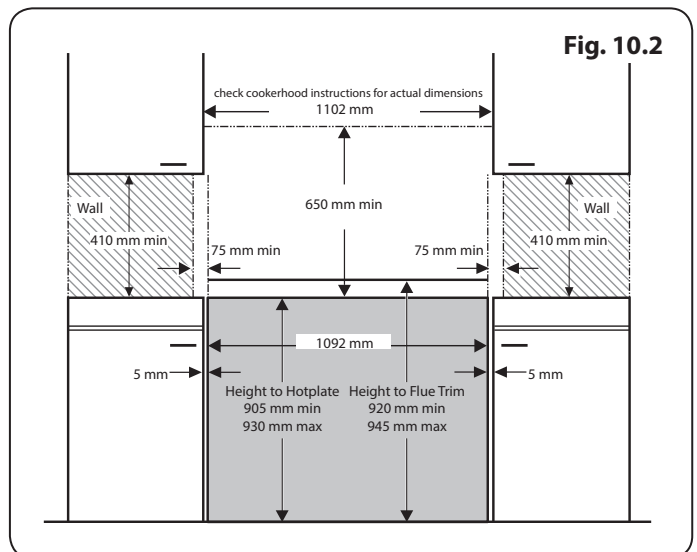
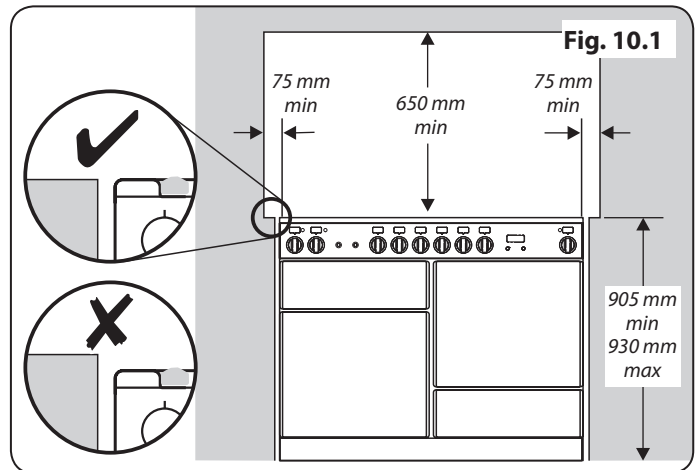

INSTALLATION

Check the appliance is electrically safe and gas sound when you have finished.

Fig. 10.5

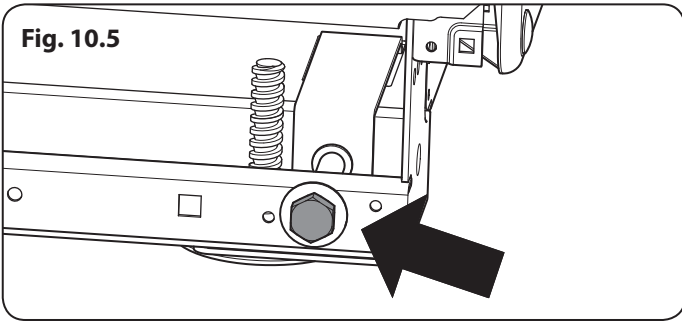

Lowering the Two Rear Rollers

To adjust the height of the rear of the cooker, first fit a 13 mm spanner or socket wrench onto the hexagonal adjusting nut (**Fig. 10.5**). Rotate the nut – clockwise to raise – counter-clockwise to lower.

Make 10 complete (360°) turns clockwise.

Make sure you lower BOTH REAR ROLLERS.

Fig. 10.6

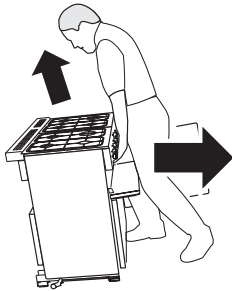

Completing the Move

Unfold the rear edge of the cardboard base tray. Open the oven doors so that you can get a good grip on the bottom of the fascia panel as you move the oven (**Fig. 10.6**).

Carefully push the cooker backwards off the base tray. Remove the base tray.

Position the cooker close to its final position, leaving just enough space to get behind it **Fig. 10.7**.

⚠ DO NOT use the door handles or control knobs to manoeuvre the cooker.

Fig. 10.7

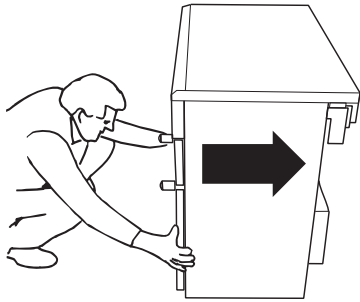

Fitting the Stability Bracket or Chain

Unless otherwise stated, a cooker using a flexible gas connector must be secured with a suitable stability device.

Suitable stability devices are shown in **Fig. 10.8** and **Fig. 10.9**.

If you are using a stability chain (**Fig. 10.8**) then the chain should be kept as short as is practicable and fixed firmly to the rear of the cooker.

If you are using a stability bracket; first attach the bracket location device to the rear of the cooker (**Fig. 10.9**). Then adjust the bracket to engage through the slot of the device (**Fig. 10.10** and **Fig. 10.11**).

Fig. 10.8

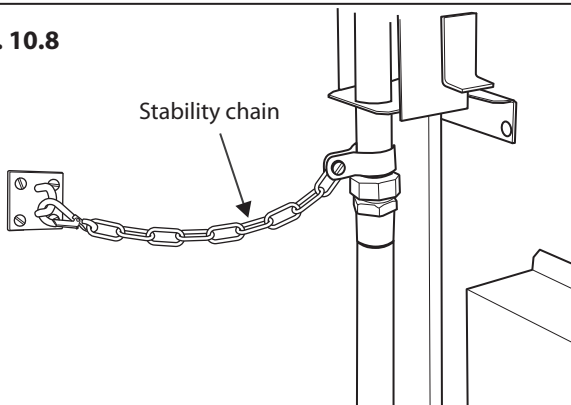
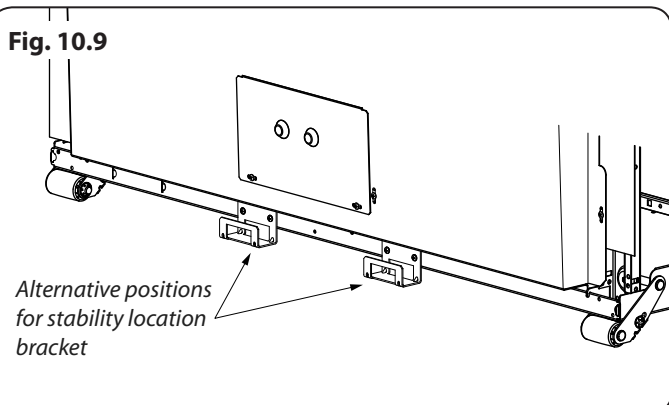

Fig. 10.9



INSTALLATION

Check the appliance is electrically safe and gas sound when you have finished.

Repositioning the Cooker Following Connection

If you need to move the cooker once it has been connected then you need to unplug it and, having gripped under the fascia panel and lifted the front of the cooker slightly (**Fig. 10.6**); you need to check behind the cooker to make sure that the gas hose is not caught.

As you progress, make sure that both the electricity cable and gas hose always have sufficient slack to allow the cooker to move.

With a stability chain fitted, release it as you ease the cooker out. Do not forget to refit it when you replace the cooker.

When you replace the cooker, again check behind to make sure that the electricity cable and gas hose are not caught or trapped.

Conversion to Another Gas

If the appliance is to be converted to another gas do the conversion at this point. See the conversion section of these instructions.

Levelling

You are recommended to use a spirit level on a shelf in one of the ovens to check for level.

Place the cooker in its intended position taking care not to twist it within the gap between the kitchen units as damage may occur to the cooker or the units.

The front feet and rear rollers can be adjusted to level the cooker.

To adjust the height of the rear of the cooker use a 13 mm spanner or socket wrench to turn the adjusting nuts at the front bottom corners of the cooker.

To set the front, turn the feet bases to raise or lower.

Fig. 10.10

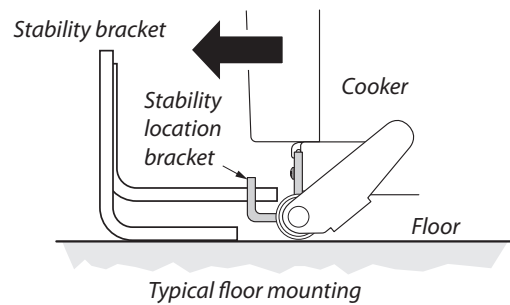
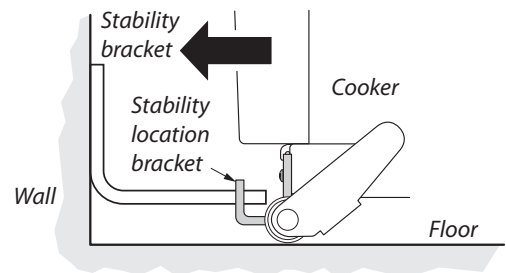

Fig. 10.11



INSTALLATION

Check the appliance is electrically safe and gas sound when you have finished.

Fig. 10.12

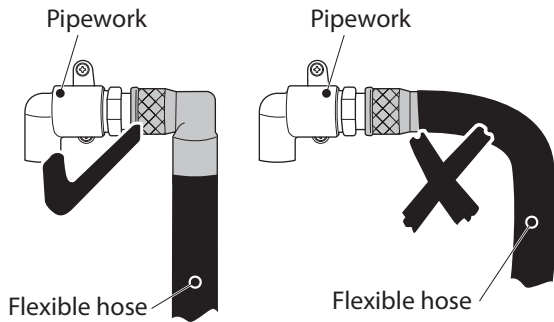

Gas Connection

This must be in accordance with the relevant standards.

The flexible hose (not supplied with the cooker) must be in accordance with the relevant standards. Hoses may be purchased at most builders' merchants.

The gas supply needs to terminate with a side facing bayonet (**Fig. 10.12**).

The connector is located just below the hotplate level at the rear of the cooker. If in doubt contact your supplier.

The rear cover boxes limit the position of the supply point.

Because the height of the cooker can be adjusted and each connection is different, it is difficult to give precise dimensions.

Although a 900 mm hose can be used, a 1250 mm hose will allow slightly more flexibility in the positioning of the bayonet and make moving the cooker easier.

The hose should be fitted so that both inlet and outlet connections are vertical so that the hose hangs downwards in a 'U' shape.

Ideally the hose supply connection should be within the shaded area 'A' (**Fig. 10.13**).

For Natural Gas, the flexible hose must be in accordance with BS669. For LP Gas, it should be capable of 50 mbar pressure and 70°C temperature rise. If in doubt contact your supplier.

Screw connect the threaded end of the hose into the gas inlet.

After completing the gas connection, make sure that the cooker is gas sound with a pressure test.

Fig. 10.13

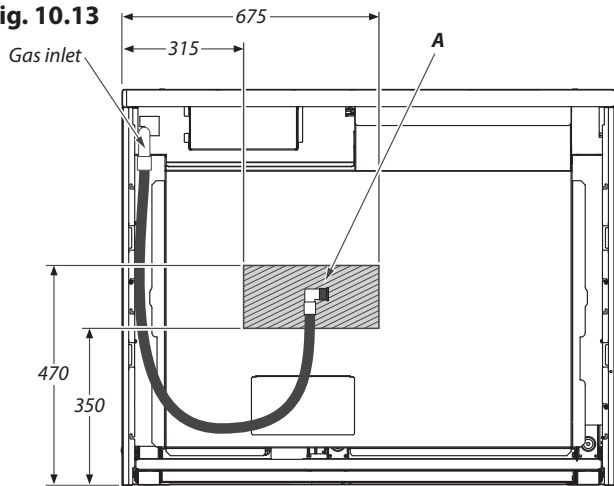

All dimensions in millimetres

Pressure Testing

The gas pressure can be measured at one of the hotplate burner injectors (not a wok burner).

Lift off a burner head. Fit the pressure gauge to the injector. Turn on and light one of the other hotplate burners.

Turn on the control knob for the burner with the pressure gauge fitted to let gas through.

See the data badge for test pressures.

Turn off the burners. Make sure that you reassemble the burner top in the correct way on the burner body.

INSTALLATION

Check the appliance is electrically safe and gas sound when you have finished.

Electrical Connection

The cooker must be installed by a qualified electrician, in accordance with all relevant British Standards/Codes of Practice (in particular BS 7671), or with the relevant national and local regulations.

⚠ WARNING: THE APPLIANCE MUST BE EARTHED.

Note: The cooker must be connected to the correct electrical supply as stated on the voltage label on the cooker, through a suitable cooker control unit incorporating a double-pole switch, having a contact separation of at least 3 mm in all poles.

⚠ The cooker MUST NOT be connected to an ordinary domestic power point.

Access to the mains terminal is gained by removing the electrical terminal cover box on the back panel. Connect the mains cable to the correct terminals for your electrical supply type (**Fig. 10.14** and **Fig. 10.15**). Check that the links are correctly fitted and that the terminal screws are tight. Secure the mains cable using the cable clamp.

Final Checks

Hob Check

Check each cooking zone in turn. Be sure to use pans of the correct size and material.

Grill Check

Turn on the grill control and check that the grill heats up.

Oven Check

Set the clock as described earlier, and then turn on the ovens. Check the oven fans start to turn and that the ovens heat up.

Final Fitting

Fitting the 2-piece Plinth

Fit the inner plinth to the bottom front of the cooker using the 4 screws provided (**Fig. 10.16**).

Fit the outer plinth (2 screws, 1 each end) to the inner plinth.

The height of the outer plinth can be adjusted by sliding it up or down via the slotted hole (**Fig. 10.17**).

Customer Care

Installer: Please complete your details in this guide, inform the user how to operate the cooker and hand over the instructions.

Thank you.

Current Operated Earth Leakage Breakers

The combined use of your induction cooker and other domestic appliances may cause nuisance tripping, so we recommend that the cooker is protected on an individual RCD (Residual Current Device) or RCBO (Residual Current Breaker with Overload).

IF IN DOUBT, PLEASE CONSULT A SUITABLY QUALIFIED ELECTRICIAN.

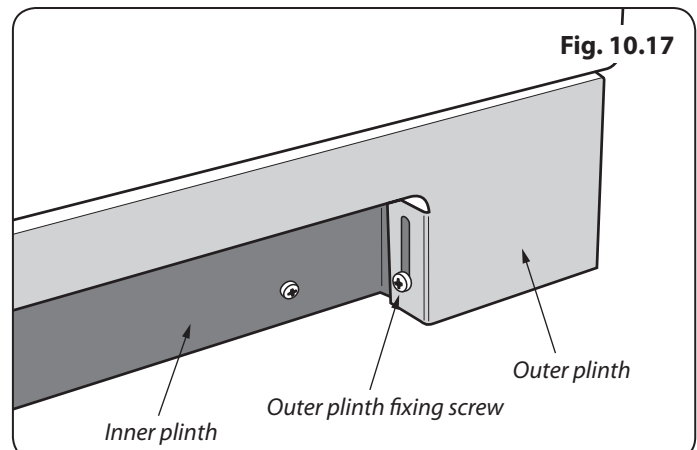
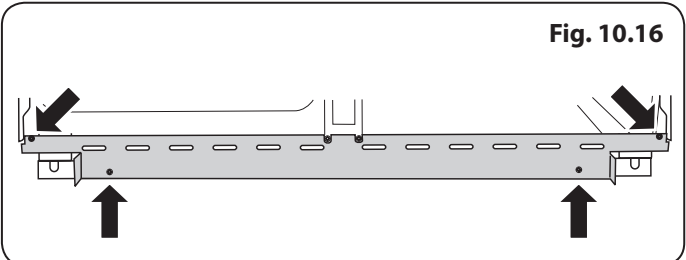
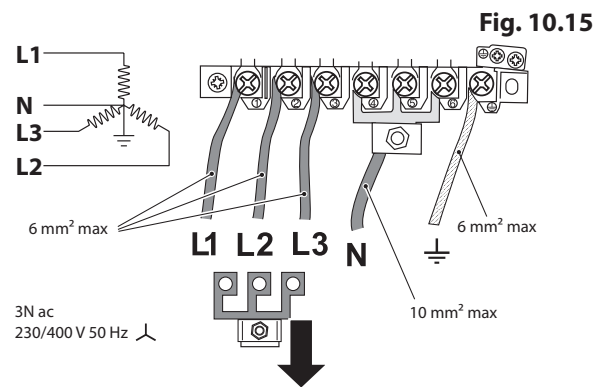
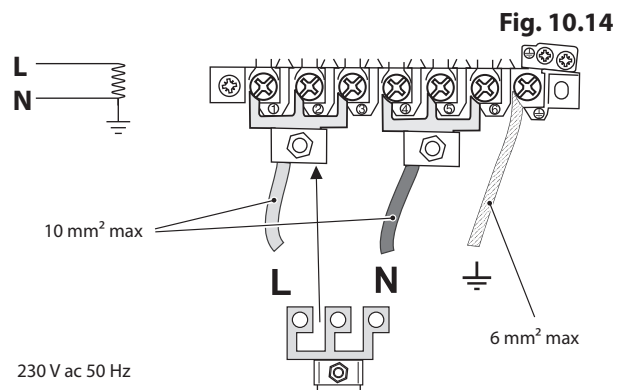

WARNING – SERVICING TO BE CARRIED OUT ONLY BY AN AUTHORISED PERSON
Disconnect from electricity and gas before servicing. Check appliance is safe when you have finished.

11. Conversion to LP Gas

Fig. 11.1

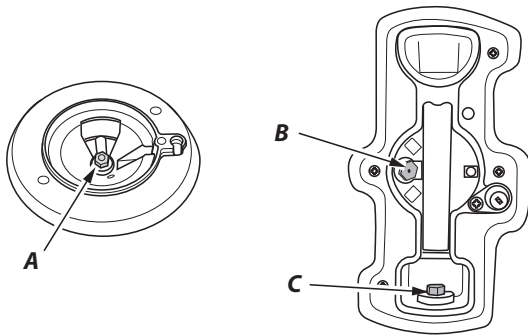

A – Jet, B – Internal injector, C – External injector

Fig. 11.2

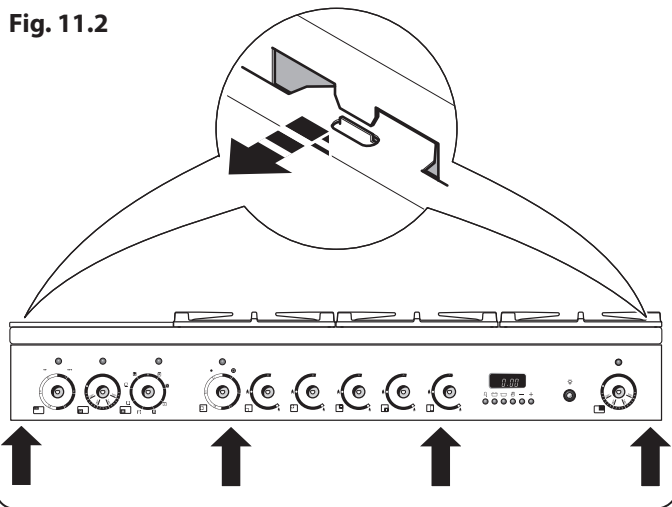
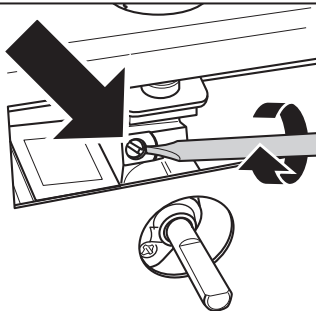

Fig. 11.3



Check the 'Technical Data' section at the back of the book that the hob is convertible to the gas you want to use.

A suitably competent person must perform the conversion. After conversion the installation must comply with the relevant regulations and also the local electricity supply company requirements. Read the instructions before converting this appliance.

- ⚠ Failure to convert the appliance correctly could invalidate any warranty or liability claims and lead to prosecution.**
- ⚠ When servicing or replacing gas-carrying components disconnect from the gas supply before starting operation. Check the appliance is gas sound after completion.**
- ⚠ DO NOT use reconditioned or unauthorised gas controls.**
- ⚠ Disconnect from the electricity and gas supply before servicing.**
- ⚠ Before electrical reconnection, check that the appliance is electrically safe.**

Injectors

Remove the burner caps and heads. Remove the old jets (Fig. 11.1). Fit the new jets (see 'Technical Data' section at the back of this book for the correct jets). Reassemble in the reverse order.

Tap Adjustment

Removing the Control Panel

Pull off all the control knobs and remove the fixing screws underneath the control panel (Fig. 11.2).

The control panel will drop down slightly. It is held at the top by two holes in the top edge, one at each end, that locate on the tags on the inner panel. Lift the control panel clear of the tags and pull forwards, taking care not to damage or strain the wiring.

Bypass Screw Adjustment

Turn the bypass screw on each control clockwise to the stop (Fig. 11.3). Refit the control panel.

Stick on Label

Stick the LP gas label over the natural gas part of the appliance data label.

WARNING – SERVICING TO BE CARRIED OUT ONLY BY AN AUTHORISED PERSON

Disconnect from electricity and gas before servicing. Check appliance is safe when you have finished.

Pressure Testing

Connect the appliance to the gas supply.

The gas pressure can be measured at one of the hotplate injectors (not a wok burner).

Lift off a burner head. Fit the pressure gauge to the jet. Turn on and light one of the other burners. Turn on and press in the control knob for the burner with the pressure gauge fitted.

The pressure should be 29 mbar for Butane and 37 mbar for Propane. After checking the pressure, turn off the taps and replace the burner head.

Reassemble burner top, making sure it is reassembled in the correct way on the burner body.

Check operation of all the burners.

Check the appliance is gas sound.

12. Circuit Diagram

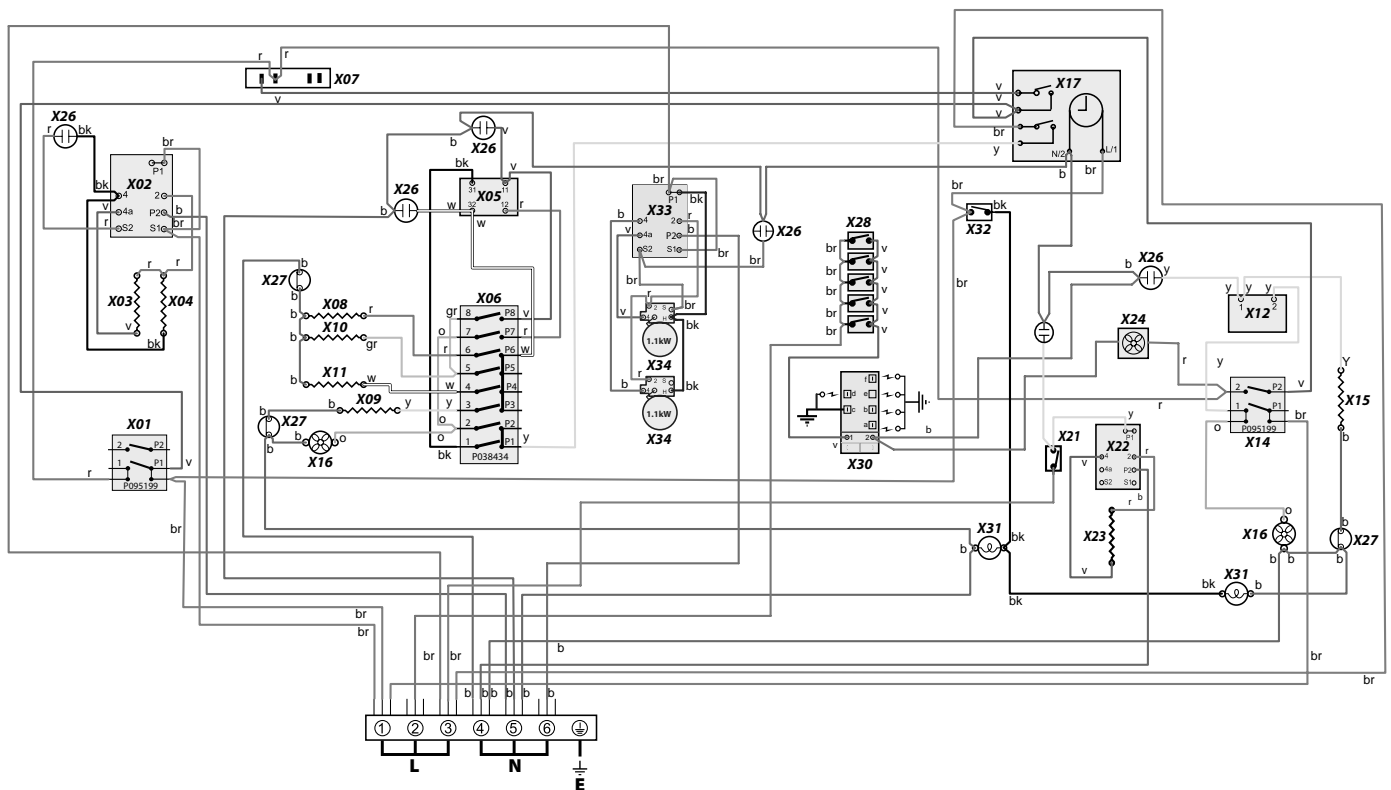

Key

The connections shown in the circuit diagram are for single-phase. The ratings are for 230V 50Hz.

Code	Description	Code	Description
X01	Grill front switch	X16	Oven Fan
X02	Grill energy control	X17	Clock /Timer
X03	Left hand Grill elements	X21	Proving drawer switch
X04	Right hand Grill elements	X22	proving drawer energy regulator
X05	Left Hand Oven Thermostat	X23	proving drawer element
X06	Left Hand Oven Switch	X24	Cooling fan
X07	Left Hand Oven Front Switch	X26	Neon
X08	Left Hand Oven Base Element	X27	Thermal cut out
X09	Left Hand Oven Fan Element	X28	Ignition switches
X10	Left Hand Oven Top Outer Element	X30	Spark generator
X11	Left Hand Oven Top Inner Element	X31	Oven light
X12	Right Hand Oven Thermostat	X32	Oven light switch
X14	Right Hand Oven Front Switch	X33	Hob Energy Regulator
X15	Right Hand Oven Fan Element	X34	Hob Element

Code	Colour
b	Blue
br	Brown
bk	Black
or	Orange
r	Red
v	Violet
w	White
y	Yellow
g/y	Green/yellow
gr	Grey

13. Technical Data

THE COOKER IS CATEGORY: CatII₂H₃+

It is supplied set for group H natural gas. A conversion kit from NG to LP is available for the cooker.

INSTALLER: Please leave these instructions with the user.

DATA BADGE LOCATION: Cooker back, serial number repeater badge below oven door opening.

COUNTRY OF DESTINATION: GB, IE.

Connections

Gas (Rp ½ at rear right-hand side)		Electric
Natural Gas	20 mbar	230/400V 50 Hz
Butane	29 mbar	
Propane	37 mbar	

See the appliance badge for test pressures.

Dimensions

Model	Classic Deluxe 110 Dual Fuel	
Overall height	minimum 905 mm	maximum 930 mm
Overall width	1092 mm	
Overall depth	608 mm excluding handles, 670 mm including handles	
Minimum height above the hotplate	650 mm	

Model	Professional Deluxe 110 Dual Fuel	
Overall height	minimum 905 mm	maximum 930 mm
Overall width	1092 mm	
Overall depth	604 mm excluding handles, 641 mm including handles	
Minimum height above the hotplate	650 mm	

Model	Elan Deluxe 110 Dual Fuel	
Overall height	minimum 905 mm	maximum 930 mm
Overall width	1092 mm	
Overall depth	608 mm excluding handles, 685 mm including handles	
Minimum height above the hotplate	650 mm	

Hotplate Ratings

Hotplate	Bypass Screw*	Natural Gas 20 mb		L.P. Gas	
			Injector		Injector
Wok burner	57	3.5 kW	internal 78	3.5 kW (246 g/h)	internal 53
			external 126		external 82
Rapide/ Large Burner	40	3 kW	134	3.0 kW (210 g/h)	87
Semi Rapide / Medium Burner	32	1.7 kW	109	1.7 kW (119 g/h)	68
Auxiliary / Small Burner	28	1 kW	75	1.0 kW (70 g/h)	51

* The valves in this cooker are fitted with adjustable bypass screws. The cooker is supplied with the bypass screws set for Natural Gas. For LPG conversion the bypass screws must be screwed all the way down.

Hotplate energy saving tips

Use cookware with a flat base.

Use the correct size cookware.

Use cookware with a lid.

Minimise the amount of liquid or fat.

When liquid starts boiling, reduce the setting.

Consumption is based on G30.

Oven energy saving tips

Cook meals together, if possible.

Keep the pre-heating time short.

Do not lengthen cooking time.

Do not open the oven door during the cooking period.

Do not forget to turn the appliance off at the end of cooking.

Hotplate Efficiency

Brand	Rangemaster
Model Identification	Classic Deluxe Professional Deluxe Elan Deluxe
Size	110
Type	Dual Fuel

Type of Hob	Gas
Number of gas burners	5
Auxiliary / Small Burner (EE gas burner)	-
Semi Rapide / Medium Burner (EE gas burner)	58%
Semi Rapide / Medium Burner (EE gas burner)	58%
Rapide / Large Burner (EE gas burner)	56%
Rapide / Large Burner (EE gas burner)	-
Wok (EE gas burner)	53%
Wok (EE gas burner)	-
Hotplate EE gas hob (*)	-

Type of Hob	Radiant
Number of electric zones	2
Zone 1 - Ø cm	14.5
Heating Technology	
Energy Consumption (EElectric cooking) - Wh/kg	180
Zone 2 - Ø cm	14.5
Heating Technology	
Energy Consumption (EElectric cooking) - Wh/kg	180
Energy Consumption (EElectric hob) - Wh/kg (*)	-

Information marked thus (*) is not required with mixed fuel hobs

Oven Data

Brand		Rangemaster
Model identification		Professional Deluxe
Mass	kg	128
Model identification		Elan Deluxe
Mass	kg	133
Model identification		Classic Deluxe
Mass	kg	133
Type of oven		Electric
Number of cavities		2
Left-hand Efficiency		
Fuel type		Electric
Cavity type		Multifunction
Power - conventional	kW	2.2
Power - forced air convection	kW	2.5
Volume	Litres	79
Energy consumption (electricity) - conventional	kWh / cycle	1.08
Energy consumption (electricity) - forced air convection	kWh / cycle	0.91
Energy efficiency index - conventional		126.1
Energy efficiency index - forced air convection		106.2
Energy class		A
Right-hand Efficiency		
Fuel type		Electric
Cavity type		Fanned
Power - conventional	kW	-
Power - forced air convection	kW	2.5
Volume	Litres	79
Energy consumption (electricity) - conventional	kWh / cycle	-
Energy consumption (electricity) - forced air convection	kWh / cycle	0.83
Energy efficiency index - conventional		-
Energy efficiency index - forced air convection		94
Energy class		A

Additional Information		
The oven complies with EN 60350-1 (electric) EN 15181 (gas)		
Maximum output @ 230V 50Hz		
Conventional		2.2 kW
Multifunction		-
Multifunction (with Rapid Response)		3.7 kW
Forced Air Convection		2.5 kW
Grill		2.3 kW
Slow Oven		-
Bread Proving Drawer		0.2 kW
Ceramic multi-zone hotplate		2.2 kW

Maximum total electrical load at 230 V (approximate total including hob, oven lights, oven fan, etc.):	11.0 kW
---	---------

Notes

Notes

Name of Appliance & Colour*				
Appliance Serial Number*				
Fuel Type*	Natural Gas	<input type="checkbox"/>	LP Gas	<input type="checkbox"/>
	Dual Fuel	<input type="checkbox"/>	Electric	<input type="checkbox"/>
Retailer's Name & Address				
Date of Purchase				
Installer's Name & Address				
Installer's Telephone Number				
Date of Installation				

*This information is on the appliance data badge - look in the appliance instructions to find out where the data badge is located.

For warranty compliance, the requirements are that the appliance:

- Has been correctly installed in accordance with current legislation, relevant British and European Standards and Codes of Practice, by a suitably competent person registered with Gas Safe or equivalent body and, where applicable, a qualified electrician.
- Has been used solely for domestic cooking purposes.
- If in use in the UK*, has not been taken abroad as a personal export. (In the Republic of Ireland conditions may vary, so consult your retailer.)
- Is not second-hand or a refurbished appliance. The manufacturer's warranty is not transferable.
- Has not been subject to misuse, accidental damage or modification, and has not deteriorated due to normal domestic wear and tear, and the manufacturer's recommendations concerning cleaning materials have been followed.
- Has not been repaired by persons or organisations other than those authorised to act on behalf of AGA Rangemaster.

Exceptions:

- Items not included under the free 1 year guarantee include pan supports, griddles, wok rings, baking trays, grill pans, trivets, filters, light bulbs and other consumable accessories.
- Any damage caused other than through normal use.
- Breakdowns associated with cooking spillage.
- Cosmetic deterioration deemed to be normal wear and tear.

This warranty is in addition to your Statutory Rights.

* Only certain models can be adapted for use with Mains Gas supplied in the Channel Islands and Isle of Man.

OUT OF WARRANTY

We recommend that Rangemaster appliances are serviced regularly throughout their life to maintain optimum performance and efficiency. Service work should only be carried out by technically competent and suitably qualified personnel.

For your own safety, always make sure that work is carried out by a Gas Safe registered engineer for gas appliances or an approved electrician for electrical models.

For a competitive quote and to arrange for a Rangemaster approved engineer to attend, call Consumer Services on: 01926 457628.

SPARE PARTS

To maintain optimum and safe performance, we recommend that only genuine Rangemaster spare parts are used. These are available from most major spares stockists, including ourselves.

Contact Consumer Services on 01926 457628, who will be happy to help.

STANDARDS

Rangemaster cookers are designed and manufactured to a recognised international quality standard, which meets the requirements of BS EN ISO 9001, BS EN ISO 14001 and OHSAS 18001 for continually improving environmental procedures.

Rangemaster cookers comply with the essential requirements of the appropriate European Directives, and carry the CE mark.

CONSUMER SERVICE

If you have any product enquiries, or in the event of a problem with your appliance once it has been installed, please telephone 01926 457628.

CONSUMER SERVICE LINES OPEN:

Monday to Thursday 8am-6pm
Friday 8am-5pm

WARRANTY

Your manufacturer warranty covers goods of our own brand for defective workmanship and materials for a period of 1 year from the date of purchase. This warranty covers mechanical breakdown and proven cosmetic and manufacturing defects.

You will receive an additional FREE full 12 months guarantee by registering your purchase using the FREEPOST form provided. Alternatively, call free on 0800 587 5747, quoting reference RMGX57A, or register online at www.rangemaster.co.uk.

Any damage, blemishes or chips identified upon receipt of the product must be reported within 90 days - proof of purchase may be required to establish validity. Scratches on the surface of ceramic hobs must be reported within 14 days. Scratches caused by usage are not covered. Accidental damage is not covered by the manufacturer's warranty.



Built from experience

Clarence Street
Royal Leamington Spa
Warwickshire
CV31 2AD
England

Consumer Services: +44 (0)1926 457628.
Fax: +44 (0)1926 450526
E-mail: consumers@agarangemaster.co.uk
www.rangemaster.co.uk

For UK Trade Enquiries Tel: +44 (0)115 946 4000
Fax: +44 (0)115 973 6602
E-mail: sales@agarangemaster.co.uk

For ROI Enquiries Tel: 1850 302 502

Rangemaster is a trading name of AGA Rangemaster Limited
Registered in England and Wales. Registration No. 354715
Registered Office: c/o Aga Rangemaster, Meadow Lane, Long Eaton, Nottingham, NG10 2GD

Rangemaster continuously seeks improvements in specification, design and production of products and thus, alterations take place periodically. Whilst every effort is made to produce up-to-date literature, this brochure should not be regarded as an infallible guide to current specification, nor does it constitute an offer for the sale of any particular appliance.

AGA RANGEmaster

