

Wickes

CORDLESS BRUSHLESS COMBI DRILL

18V LITHIUM



CDI218BW
223730

CONTENTS

GENERAL POWER TOOL SAFETY WARNINGS 3

GENERAL SAFETY WARNINGS FOR BATTERY CHARGER 6

COMPONENT LIST 7

ACCESSORIES 7

SYMBOLS 8

TECHNICAL DATA 9

NOISE INFORMATION 9

OPERATING INSTRUCTIONS 11

TROUBLESHOOTING 15

MAINTENANCE 16

ENVIRONMENTAL PROTECTION 16

PLUG REPLACEMENT (ONLY FOR REWIRABLE PLUG OF UK & IRELAND) 17

DECLARATION OF CONFORMITY 18

ORIGINAL INSTRUCTION

GENERAL POWER TOOL SAFETY WARNINGS

 **WARNING!** Read all safety warnings, instructions, illustrations and specifications provided with this power tool. Failure to follow all instructions listed below may result in electric shock, fire and/or serious injury.

SAVE ALL WARNINGS AND INSTRUCTIONS FOR FUTURE REFERENCE.

The term "power tool" in the warnings refers to your mains-operated (corded) power tool or battery-operated (cordless) power tool.

1. WORK AREA SAFETY

- a) **Keep work area clean and well lit.** Cluttered or dark areas invite accidents.
- b) **Do not operate power tools in explosive atmospheres, such as in the presence of flammable liquids, gases or dust.** Power tools create sparks which may ignite the dust or fumes.
- c) **Keep children and bystanders away while operating a power tool.** Distractions can cause you to lose control.

2. ELECTRICAL SAFETY

- a) **Power tool plugs must match the outlet. Never modify the plug in any way. Do not use any adapter plugs with earthed (grounded) power tools.**
Unmodified plugs and matching outlets will reduce risk of electric shock.
- b) **Avoid body contact with earthed or grounded surfaces, such as pipes, radiators, ranges and refrigerators.** There is an increased risk of electric shock if your body is earthed or grounded.
- c) **Do not expose power tools to rain or wet conditions.** Water entering a power tool will increase the risk of electric shock.
- d) **Do not abuse the cord. Never use the cord for carrying, pulling or unplugging the power tool. Keep cord away from heat, oil, sharp edges or moving parts.** Damaged or entangled cords increase the risk of electric shock.
- e) **When operating a power tool outdoors, use an extension cord suitable for outdoor use.** Use of a cord suitable for outdoor use reduces the risk of electric shock.
- f) **If operating a power tool in a damp location is unavoidable, use a residual current device (RCD)**

protected supply. Use of an RCD reduces the risk of electric shock.

3. PERSONAL SAFETY

- a) **Stay alert, watch what you are doing and use common sense when operating a power tool. Do not use a power tool while you are tired or under the influence of drugs, alcohol or medication.** A moment of inattention while operating power tools may result in serious personal injury.
- b) **Use personal protective equipment. Always wear eye protection.** Protective equipment such as dust mask, non-skid safety shoes, hard hat, or hearing protection used for appropriate conditions will reduce personal injuries.
- c) **Prevent unintentional starting. Ensure the switch is in the off-position before connecting to power source and/or battery pack, picking up or carrying the tool.** Carrying power tools with your finger on the switch or energising power tools that have the switch on invites accidents.
- d) **Remove any adjusting key or wrench before turning the power tool on.** A wrench or a key left attached to a rotating part of the power tool may result in personal injury.
- e) **Do not overreach. Keep proper footing and balance at all times.** This enables better control of the power tool in unexpected situations.
- f) **Dress properly. Do not wear loose clothing or jewellery. Keep your hair and clothing away from moving parts.** Loose clothes, jewellery or long hair can be caught in moving parts.
- g) **If devices are provided for the connection of dust extraction and collection facilities, ensure these are connected and properly used.** Use of dust collection can reduce dust-related hazards.
- h) **Do not let familiarity gained from frequent use of tools allow you to become complacent and ignore tool safety principles.** A careless action can cause severe injury within a fraction of a second.

4. POWER TOOL USE AND CARE

- a) **Do not force the power tool. Use the correct power tool for your application.** The correct power tool will do the job better and safer at the rate for which it was designed.
- b) **Do not use the power tool if the switch does not turn it on and off.** Any power tool that cannot be controlled with the switch is dangerous and must be

GENERAL POWER TOOL SAFETY WARNINGS

repaired.

- c) **Disconnect the plug from the power source and/or remove the battery pack, if detachable, from the power tool before making any adjustments, changing accessories, or storing power tools.** Such preventive safety measures reduce the risk of starting the power tool accidentally.
- d) **Store idle power tools out of the reach of children and do not allow persons unfamiliar with the power tool or these instructions to operate the power tool.** Power tools are dangerous in the hands of untrained users.
- e) **Maintain power tools and accessories. Check for misalignment or binding of moving parts, breakage of parts and any other condition that may affect the power tool's operation. If damaged, have the power tool repaired before use.** Many accidents are caused by poorly maintained power tools.
- f) **Keep cutting tools sharp and clean.** Properly maintained cutting tools with sharp cutting edges are less likely to bind and are easier to control.
- g) **Use the power tool, accessories and tool bits etc. in accordance with these instructions, taking into account the working conditions and the work to be performed.** Use of the power tool for operations different from those intended could result in a hazardous situation.
- h) **Keep handles and grasping surfaces dry, clean and free from oil and grease.** Slippery handles and grasping surfaces do not allow for safe handling and control of the tool in unexpected situations.

5. BATTERY TOOL USE AND CARE

- a) **Recharge only with the charger specified by the manufacturer.** A charger that is suitable for one type of battery pack may create a risk of fire when used with another battery pack.
- b) **Use power tools only with specifically designated battery packs.** Use of any other battery packs may create a risk of injury and fire.
- c) **When battery pack is not in use, keep it away from other metal objects, like paper clips, coins, keys, nails, screws or other small metal objects, that can make a connection from one terminal to another.** Shorting the battery terminals together may cause burns or a fire.
- d) **Under abusive conditions, liquid may be ejected from the battery; avoid contact. If contact accidentally occurs, flush with water. If liquid contacts eyes, additionally seek medical help.** Liquid ejected from the battery may cause irritation or burns.
- e) **Do not use a battery pack or tool that is damaged or modified.** Damaged or modified batteries may exhibit unpredictable behaviour resulting in fire, explosion or risk of injury.
- f) **Do not expose a battery pack or tool to fire or excessive temperature.** Exposure to fire or temperature above 130 °C may cause explosion.
- g) **Follow all charging instructions and do not charge the battery pack or tool outside the temperature range specified in the instructions.** Charging improperly or at temperatures outside the specified range may damage the battery and increase the risk of fire.

6. SERVICE

- a) **Have your power tool serviced by a qualified repair person using only identical replacement parts.** This will ensure that the safety of the power tool is maintained.
- b) **Never service damaged battery packs.** Service of battery packs should only be performed by the manufacturer or authorized service providers.

DRILL SAFETY WARNINGS

1) Safety instructions for all operations

- a) **Wear ear protectors when impact drilling.** Exposure to noise can cause hearing loss.
 - b) **Hold power tool by insulated gripping surfaces, when performing an operation where the cutting accessory may contact hidden wiring.** Cutting accessory contacting a "live" wire may make exposed metal parts of the power tool "live" and could give the operator an electric shock.
- ## 2) Safety instructions when using long drill bits
- a) **Never operate at higher speed than the maximum speed rating of the drill bit. At higher speeds, the bit is likely to bend if allowed to rotate freely without contacting the workpiece, resulting in personal injury.**

- b) **Always start drilling at low speed and with the bit tip in contact with the workpiece. At higher speeds, the bit is likely to bend if allowed to rotate freely without contacting the workpiece, resulting in personal injury.**
- c) **Apply pressure only in direct line with the bit and do not apply excessive pressure. Bits can bend causing breakage or loss of control, resulting in personal injury.**

SAFETY WARNINGS FOR BATTERY PACK

- a) **Do not dismantle, open or shred cells or battery pack.**
- b) **Do not short-circuit a battery pack. Do not store battery packs haphazardly in a box or drawer where they may short-circuit each other or be short-circuited by conductive materials.** *When battery pack is not in use, keep it away from other metal objects, like paper clips, coins, keys, nails, screws or other small metal objects, that can make a connection from one terminal to another. Shorting the battery terminals together may cause burns or a fire.*
- c) **Do not expose battery pack to heat or fire. Avoid storage in direct sunlight.**
- d) **Do not subject battery pack to mechanical shock.**
- e) **In the event of battery leaking, do not allow the liquid to come into contact with the skin or eyes. If contact has been made, wash the affected area with copious amounts of water and seek medical advice.**
- f) **Seek medical advice immediately if a cell or battery pack has been swallowed.**
- g) **Keep battery pack clean and dry.**
- h) **Wipe the battery pack terminals with a clean dry cloth if they become dirty.**
- i) **Battery pack needs to be charged before use. Always refer to this instruction and use the correct charging procedure.**
- j) **Do not maintain battery pack on charge when not in use.**
- k) **After extended periods of storage, it may be necessary to charge and discharge the battery pack several times to obtain maximum performance.**
- l) **Battery pack gives its best performance when it is operated at normal room temperature (20 °C ± 5 °C).**
- m) **When disposing of battery packs, keep battery packs of different electrochemical systems separate from each other.**
- n) **Recharge only with the charger specified by manufacturer. Do not use any charger other than that specifically provided for use with the equipment.** *A charger that is suitable for one type of battery pack may create a risk of fire when used with another battery pack.*
- o) **Do not use any battery pack which is not designed for use with the equipment.**
- p) **Keep battery pack out of the reach of children.**
- q) **Retain the original product literature for future reference.**
- r) **Remove the battery from the equipment when not in use.**
- s) **Dispose of properly.**
- t) **Do not mix cells of different manufacture, capacity, size or type within a device.**
- u) **Do not remove battery pack from its original packaging until required for use.**
- v) **Observe the plus (+) and minus (-) marks on the battery and ensure correct use.**

GENERAL SAFETY WARNINGS FOR BATTERY CHARGER

 **WARNING!** Read all safety warnings and all instructions. Failure to follow the warnings and instructions may result in electric shock, fire and/or serious injury.

Save all warnings and instructions for future reference.

This appliance can be used by children aged from 8 years and above and persons with reduced physical, sensory or mental capabilities or lack of experience and knowledge if they have been given supervision or instruction concerning use of the appliance in a safe way and understand the hazards involved. Children shall not play with the appliance. Cleaning and user maintenance shall not be made by children without supervision.

Additional safety instructions for your Battery Charger

1. Before charging, read the instructions.
2. Do not charge a leaking battery.
3. Do not use chargers for works other than those for which they are designed.
4. Before charging, ensure your charger is matching the local AC supply.
5. For indoor use only.
6. The charging device must be protected from moisture.
7. Do not short out the contacts of battery or charger.
8. Respect the polarity “+/-“ when charging.
9. Do not open the unit and keep out of the reach of children.
10. Do not charge the batteries of other manufactures or ill-suited models.
11. Ensure that the connection between the battery charger and battery is correctly positioned and is not obstructed by foreign bodies.
12. Keep battery charger's slots are free of foreign objects and protect against dirt and humidity. Store in a dry and frost-free place.
13. When charging batteries, ensure that the battery charger is in a well-ventilated area and away from inflammable materials. Batteries can get hot during charging. Do not overcharge any batteries. Ensure that batteries and chargers are not left unsupervised during charging.
14. Do not recharge non-rechargeable batteries, as they can overheat and break.
15. Longer life and better performance can be obtained if the battery pack is charged when the air temperature is between 18°C and 24°C. Do not charge the battery pack in air temperatures below 0°C, or above 40°C. This is important as it can prevent serious damage to the battery pack.
16. Charge only battery pack of the same model provided by manufacturer and of models recommended by manufacturer.

COMPONENT LIST

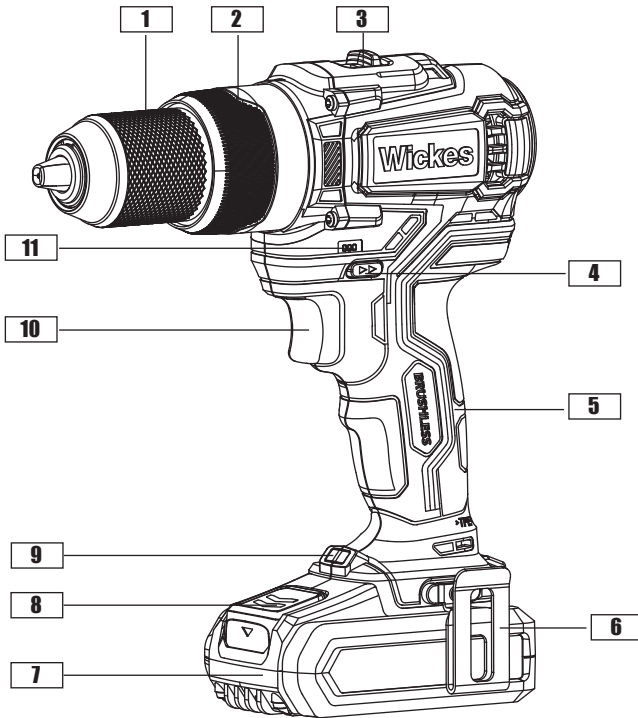

- | | | | |
|----------|----------------------------------|-----------|-----------------------------|
| 1 | Keyless chuck | 7 | Battery pack |
| 2 | Torque adjustment ring | 8 | Battery pack release button |
| 3 | Two-speed gear control | 9 | LED light |
| 4 | Forward/Reverse rotation control | 10 | On/off switch |
| 5 | Soft grip handle | 11 | Battery capacity indicator |
| 6 | Belt clip | | |

ACCESSORIES

- | | |
|---------------------------------|---|
| Charger (ACG1820W1) | 1 |
| Battery pack (ABP1820HW) | 2 |
| Belt clip | 1 |
| Double ended bits (PH2 / SL5.5) | 1 |

We recommend that you purchase your accessories from the same store that sold you the tool. Refer to the accessory packaging for further details. Store personnel can assist you and offer advice.

SYMBOLS



To reduce the risk of injury, read all of this instruction manual



Warning



Wear ear protection



Wear eye protection



Wear dust mask



Do not burn



Batteries may enter water cycle if disposed improperly, which can be hazardous for ecosystem. Do not dispose of waste batteries as unsorted municipal waste.



Read the operator's manual.



Li-ion battery. This product has been marked with a symbol relating to 'separate collection' for all battery packs and battery pack. It will then be recycled or dismantled in order to reduce the impact on the environment. Battery packs can be hazardous for the environment and for human health since they contain hazardous substances.



Indoor use only



Double insulated

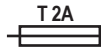

Fuse



Positive terminal



Negative terminal



Waste electrical products must not be disposed of with household waste. Please recycle where facilities exist. Check with your local authorities or retailer for recycling advice.

TECHNICAL DATA

Voltage		18V 
No load speed		0-500/0-2000 /min
Impact rate		0-8000/0-32000bpm
Number of clutch positions		22+1+1
Max torque		60N.m
Chuck capacity		13mm
Charger Protection class		 /II
Charging time		1 hr
Charger Input		100-240V~50/60Hz, 55W
Charger Output		18V  2.0 A
Max. drilling capacity	Steel	13mm
	Wood	40mm
	Masonry	16mm
Machine weight		1.50 Kg
Battery capacity		2.0Ah Li-ion battery

For additional battery technical data, refer to the rating plate on the battery pack.

*Voltage measured without workload. Initial battery voltage reaches maximum of 20 volts. Nominal voltage is 18 volts.

NOISE INFORMATION

A weighted sound pressure

L_{pA} : 82 dB(A)

A weighted sound power

L_{WA} : 93 dB(A)

K_{pA} & K_{WA}

5 dB(A)

Wear ear protection.

VIBRATION INFORMATION

Vibration total values (triax vector sum) determined according to EN 62841:	
Drilling into metal	Vibration emission value $a_{h,D} = 4.02 \text{ m/s}^2$
	Uncertainty $K = 1.5 \text{ m/s}^2$
Impact drilling into concrete	Vibration emission value $a_{h,D} = 8.23 \text{ m/s}^2$
	Uncertainty $K = 1.5 \text{ m/s}^2$

The declared vibration total value and the declared noise emission value have been measured in accordance with a standard test method and may be used for comparing one tool with another.

The declared vibration total value and the declared noise emission value may also be used in a preliminary assessment of exposure.

WARNING! The vibration and noise emissions during actual use of the power tool can differ from the declared value depending on the ways in which the tool is used especially what kind of workpiece is processed dependant on the following examples and other variations on how the tool is used:

How the tool is used and the materials being cut or drilled.

The tool being in good condition and well maintained.

The use of the correct accessory for the tool and ensuring it is sharp and in good condition.

The tightness of the grip on the handles and if any anti vibration and noise accessories are used.

And the tool is being used as intended by its design and these instructions.

This tool may cause hand-arm vibration syndrome if its use is not adequately managed.

WARNING! To be accurate, an estimation of exposure level in the actual conditions of use should also take account of all parts of the operating cycle such as the times when the tool is switched off and when it is running idle but not actually doing the job. This may significantly reduce the exposure level over the total working period helping to minimise your vibration and noise exposure risk.

Always use sharp chisels, drills and blades.

Maintain this tool in accordance with these instructions and keep well lubricated (where appropriate).

If the tool is to be used regularly then invest in anti vibration and noise accessories.

Plan your work schedule to spread any high vibration tool use across a number of days.

OPERATING INSTRUCTIONS



NOTE: Before using the tool, read the instruction book carefully.

Intended Use

The machine is intended for driving in and loosening screws as well as for drilling in wood, metal and plastic.

BEFORE PUTTING INTO OPERATION

A) CHARGING THE BATTERY

- a) Do not use any charger other than that specifically provided for use with the equipment.
- b) If the battery pack is very hot you must remove your battery pack from the charger and allow time for the battery to cool down before recharging.
- c) The battery in your new tool is not charged when it leaves the factory. It must be fully charged before using for the first time.
- d) The battery must be fully charged before storage. If the tool is not used for long periods, recharge the battery at least every 3-6 months.

B) TO REMOVE THE BATTERY PACK (See Fig. A1)

Depress the battery pack release button (8) firmly first and then slide the battery pack (7) out from your tool.

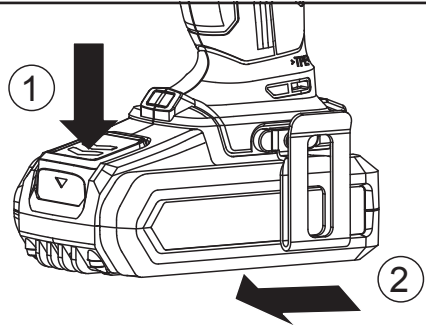

Fig. A1

C) TO INSTALL THE BATTERY PACK (See Fig. A2)

Slide the fully charged battery pack (7) onto the tool with sufficient force until it clicks into position.

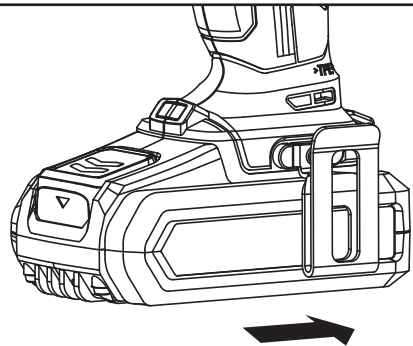



Fig. A2

D) HOW TO CHARGE YOUR BATTERY PACK (See Fig. A3)

CHARGING PROCEDURE

- 1) Plug the charger (12) into an appropriate outlet. The green LED will be lit.
- 2) Slide the battery pack (7) into the charger, the red LED will light to indicate charging.
- 3) When charging is completed, the green LED will light. The pack is now fully charged, unplug the charger and remove the battery pack.

WARNING: If the battery pack is warm e.g. after continuous use or after exposure to direct sunlight or heat, allow time to cool down before re-charging to achieve the full charge.

Light	Status
Red on ● 	Charging
Green on ● 	Fully Charged

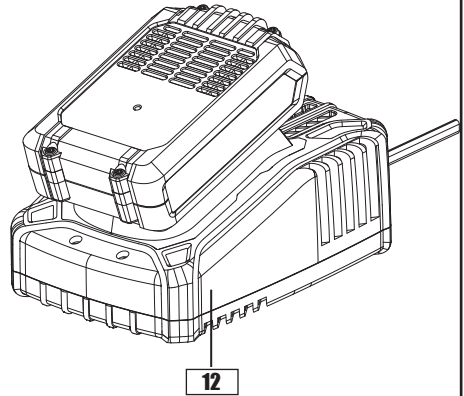

Fig. A3

OPERATION

1. ON / OFF SWITCH (See Fig. B)

Depress the On/Off switch (10) to start and release it to stop your drill. The on/off switch (10) is fitted with a brake function which stops your chuck immediately when you quickly release the switch.

It is also a variable speed switch that delivers higher speed and torque with increased trigger pressure. Speed is controlled by the amount of On/Off switch (10) depression.

WARNING! Do not operate for long periods at low speed because excess heat will be produced internally.

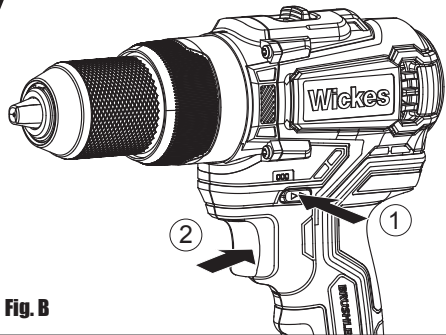

Fig. B

2. SWITCH LOCK (See Fig. B)

The On/Off switch (10) can be locked in the OFF position. This helps to reduce the possibility of accidental starting when not in use. To lock the On/Off switch (10), place the rotation control (4) in the center position.

3. DIRECTION CONTROL (See Fig. C1, C2)

Forward rotating: push the forward/reverse rotation control (4) to the right (the drill points to you). It is used for drilling and screw driving.

Reverse rotation: push the forward/reverse rotation control (4) to the left (the drill points to you). It is used for remove screws or release a jammed drill bit.

⚠ WARNING! Never change the direction of rotation when the chuck is rotating, wait until it has stopped!

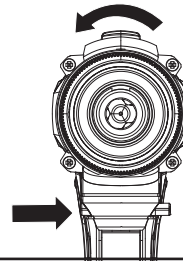

Fig. C1

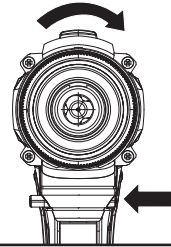

Fig. C2

4. TWO-SPEED GEAR CONTROL (See Fig. D)

This drill has a two-speed gear control (3) designed for drilling or driving at low or high speeds. A slide switch is located on top of the the drill to change between gears. When using the drill in the low gear, speed will decrease but the drill will have greater torque. At higher speeds, the torque will be reduced.

GEAR I Low speeds range: for screwdriving or working with large drilling diameter

GEAR II High speed range: for working with small drilling diameter

⚠ WARNING! To prevent gear damage, always allow the chuck to come to a complete stop before changing the direction of rotation or the two-speed gear control.

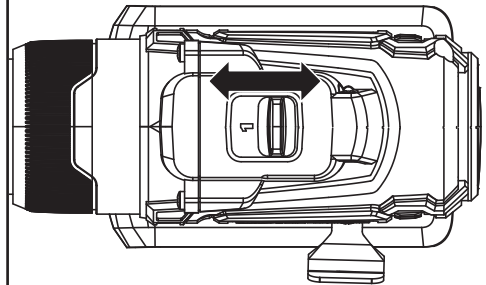

Fig. D

5. CHUCK ADJUSTMENT (See Fig. E)

To open the chuck jaws rotate the front section of the chuck (1). Insert the drill bit between the chuck jaws and rotate the front section in the opposite direction. Ensure the drill bit is in the center of the chuck jaws. Finally, firmly rotate the front chuck section in the opposite directions. Your drill bit is now clamped in the chuck.

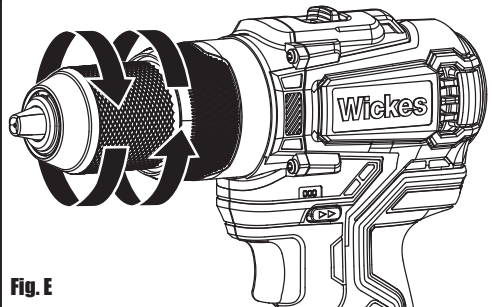

Fig. E

6. TORQUE ADJUSTMENT (See Fig. F)

(Screw driving force of your drill)

The torque is adjusted by rotating the torque adjustment ring (2). The torque is greater when the torque adjustment ring is set on a higher setting. The torque is less when the torque adjustment ring is set on a lower setting.

Make the setting as follows:

1 - 4 for driving small screws

5 - 9 for driving screws into soft material

10 - 14 for driving screws into soft and hard material

15 - 20 for driving screws into hard wood

21 -22 for driving larger screws

 for heavy drilling

 for drilling in masonry and concrete

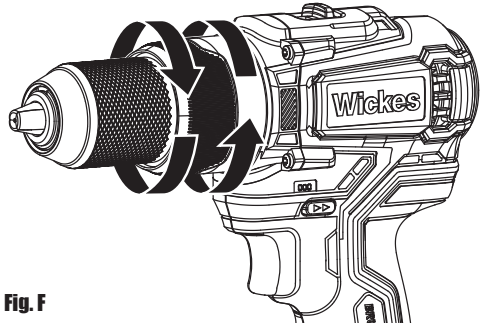

Fig. F

7. USING THE WORK LIGHT

The work light (9) will illuminate whenever the On/Off switch (10) is pressed. LED lighting increases visibility, great for dark or enclosed areas.

8. BELT CLIP

Screw the belt clip (6) on the tool with the screw provided in the plastic bag. The belt clip (6) can be hooked on your belt or pocket, etc.

9. BATTERY CAPACITY INDICATOR (See Fig. G)

Your tool is equipped with battery capacity indicator. Press the on/off switch halfway or fully, the battery capacity indicator will light up to show the amount of charge left in the battery.

Fuel Gauge	Capacity
Red on	0-33%
Red on +Yellow on	33%-66%
Red on +Yellow on + Green on	66%-100%
Green on	Fully Charged

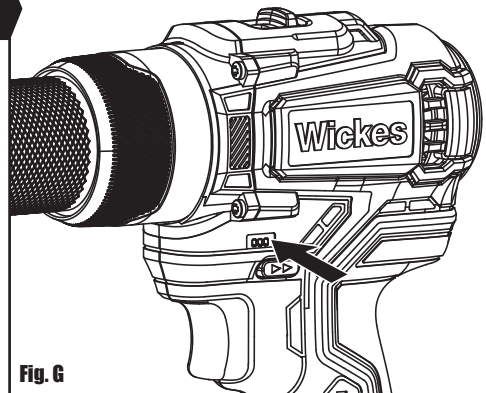



Fig. G

10. DRILLING

When drilling into a hard smooth surface, use a center punch to mark the desired hole location. This will prevent the drill bit from slipping off center as the hole is started. Hold the tool firmly and place the tip of the bit at the point to be drilled. Depress the On/Off switch (10) to start the tool. Move the drill bit into the workpiece, applying only enough pressure to keep the bit cutting. Do not force or apply side pressure to elongate a hole.

For drilling in metal or wood, turn the adjustment ring (2) to the drill position . For drilling in masonry or concrete, turn to the torque selector to the hammer position .

 **Tungsten carbide drill bits should always be used for concrete and masonry. When drilling in metal, only use HSS drill bits in good condition. Always use a magnetic bit holder (not included) when using short screwdriver bits. When screw-driving, apply a small quantity of lubricant to the screw threads to ease insertion.**

11. DISPOSAL OF AN EXHAUSTED BATTERY PACK



To preserve natural resources, please recycle or dispose of the battery pack properly. This battery pack contains Lithium batteries. Consult your local waste authority for information regarding available recycling and/or disposal options. Discharge your battery pack by operating your drill, then remove the battery pack from the drill housing and cover the battery pack connections with heavy-duty adhesive tape to prevent short circuit and energy discharge. Do not attempt to open or remove any of the components.

12. OVERLOAD PROTECTION

When overloaded, the motor comes to a stop. Relieve the load on the machine immediately and allow cooling for approx. 30 seconds at the highest no-load speed.

13. TEMPERATURE DEPENDENT OVERLOAD PROTECTION

This power tool has over-load protection built in. If the load is too high or the battery temperature exceeds 75°C, the electronic control switches off the power tool until the battery has cooled.

14. PROTECTION AGAINST DEEP DISCHARGING



The Li-ion battery is protected against deep discharging by the "Discharging Protection System". When the battery is empty, the machine is switched off by means of a protective circuit: The inserted tool no longer rotates.

TROUBLESHOOTING

1. WHY DOES THE DRILL NOT TURN WHEN YOU PRESS THE SWITCH?

The forward/reverse rotation control (4), which is on top of the trigger, is positioned in the lock function. Unlock the forward/reverse rotation control (4) by putting it into the required rotation position. Push the On/Off switch (10) and the drill will start to rotate.

2. THE DRILL STOPS BEFORE THE SCREW IS COMPLETELY TIGHTENED. WHY?

Verify the torque position of the torque adjusting ring (2), you can find the torque adjusting ring between the chuck and the drill body. Position 1 is the lowest torque (screw driving force) and position 22 is the highest torque (screw driving force). Position  is for drill operation. Position  is for hammer drill operation. Regulate the torque adjusting ring to a higher position to reach the best result.

3. REASONS FOR DIFFERENT BATTERY PACK WORKING TIMES

Charging time problems, as above, and having not used a battery pack for a prolonged time will reduce the battery pack working time. This can be corrected after several charge and discharge operations by charging & working with your drill. Heavy working conditions such as large screws into hard wood will use up the battery pack energy faster than lighter working conditions. Do not re-charge your battery pack below 0°C and above 40°C as this will affect performance.

MAINTENANCE

Remove the battery pack from the tool before carrying out any adjustment, servicing or maintenance. Your tool requires no additional lubrication or maintenance.

There are no user serviceable parts in your power tool. Never use water or chemical cleaners to clean your power tool. Wipe clean with a dry cloth. Always store your power tool in a dry place. Keep the motor ventilation slots clean. Keep all working controls free of dust. Occasionally you may see sparks through the ventilation slots. This is normal and will not damage your power tool.

For Battery tools

The ambient temperature range for the use and storage of tool and battery is 0°C-45°C.

The recommended ambient temperature range for the charging system during charging is 0°C-40°C.

ENVIRONMENTAL PROTECTION



Waste electrical products must not be disposed of with household waste. Please recycle where facilities exist. Check with your local authorities or retailer for recycling advice.

PLUG REPLACEMENT (ONLY FOR REWIRABLE PLUG OF UK & IRELAND)

If you need to replace the fitted plug then follow the instructions below.

IMPORTANT

The wires in the mains lead are colored in accordance with the following code:

Blue = Neutral

Brown = Live

As the colors of the wires in the mains lead of this appliance may not correspond with the colored markings identifying the terminals in your plug, proceed as follows. The wire which is colored blue must be connected to the terminal which is marked with N. The wire which is colored brown must be connected to the terminal which is marked with L.



WARNING:

Never connect live or neutral wires to the earth terminal of the plug. Only fit an approved 13A BS1363/A plug and the correct rated fuse.

Note: If a moulded plug is fitted and has to be removed take great care in disposing of the plug and severed cable, it must be destroyed to prevent engaging into a socket.

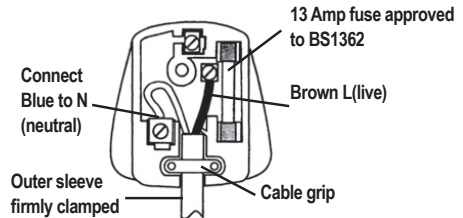

DECLARATION OF CONFORMITY

We,
Wickes Building Supplies Limited

Declare that this product: CORDLESS BRUSHLESS COMBI DRILL

Description and SKU code: 223730

Complies with the following Directives and Regulations:

2006/42/EC, Machinery Directive

2014/30/EU, Electromagnetic Compatibility Directive

2011/65/EU & (EU)2015/863 (RoHS), Restriction of Hazardous Substances Directive

2014/35/EU, Low Voltage Directive

and conforms to the following standards:

Standards specific to this product:

EN 55014-1

EN 55014-2

EN 62841-1

EN 62841-2-1

EN 60335-1

EN 60335-2-29

EN 62233

EN 61000-3-2

EN 61000-3-3

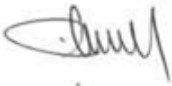

28th January, 2021

Philip Ansell

Category Technical Manager

Wickes

Vision House

19 Colonial Way

Watford

WD24 4JL"

Customer Helpline 0345 2005409