

SHOWER SEAT









Thank you for purchasing this Croydex product. Please follow the fixing and care instructions to ensure your shower seat is fitted safely and retains its high quality finish.

PLEASE RETAIN THIS LEAFLET FOR FUTURE REFERENCE.

This installation guide applies to the following product:

AP1201 - Wall Mounted Shower Seat**

TOOLS AND FITTINGS REQUIRED - NOT SUPPLIED

Stainless Steel M8 x 60mm Coach Screws	A  5x	Pencil	
10mm x 50mm Wall Plug	B  5x	Tape Measure	
Stainless Steel M8 Washers	C  5x	Spirit Level	
Hex Socket Screwdriver		Drill and Masonry Bit	
		Silicone Sealant (Optional)	

 **NOTE: Recommended fixings listed above must only be used on solid walls.**

 **NOTE: DO NOT use countersunk screws.**

KEEP DIY TOOLS OUT OF REACH OF CHILDREN

HOME SAFETY ADVICE

- It is recommended that two people fit this product to ensure that it is fitted safely.
- Always take care when using power tools, particularly in the bathroom.
- Always check for hidden cables and pipework before drilling and take extreme care if there is any water in the working area.
- It is advisable to use a residual current circuit breaker (RCCB).
- Always wear suitable eye protection when drilling.
- If the product is to be fitted on a ceramic tiled wall, a ceramic drill bit should be used.
- Always ensure that the drill hole passes through the central tiled area rather than through the grouted area. To prevent damage to the tile, mask the area around the hole with tape before drilling.
- Do not strike the product with hard or sharp objects.

FIXING SAFETY ADVICE

This product must be fitted to solid brick and concrete block walls only to support the maximum safe working load.

 **NOTE: Lightweight thermal blocks, aerated hollow brickwork or prefabricated partition walls will reduce the maximum safe working load of this product.**

Maximum safe working load for the shower seat is 100kg when fitted to a solid wall.

Shower seats are only as strong as the wall to which they are fixed and the fixings that are used.

For different wall types you will need to ensure that you are using the correct type of fixing for the material of the wall.

The addition of backboards on the outside of the wall or appropriate strengthening of internal structures may be required to provide adequate wall strength.

PRODUCT CARE

To retain the best quality finish, clean product regularly with a soft damp cloth.
Do not use abrasive or chemical cleaners as these will damage the product.
Dry the shower seat after use.

FITTING INSTRUCTION

1. Identify the most appropriate position for the shower seat ensuring the product is at a comfortable height and distance for showering.
2. The product can be folded upwards for more convenient storage so please ensure there is sufficient space above the fixing position to allow for this.
3. Place the shower seat in the desired position on the wall and using the slot centres located on the wall bracket as a template, mark the screw fixing positions on the wall surface, ensuring the product is level. **ALL FIXING SLOTS MUST BE USED** (See Fig.1).
4. Drill the holes in the marked positions using a masonry drill. If the product is to be fitted onto a ceramic tiled wall, a ceramic drill bit must be used.
5. Insert wall plugs (if applicable) flush to the surface of the wall. If fitting to a tiled surface, the wall plugs should be inserted below the surface of the tile to avoid cracking.
6. Insert the fixings through the washers and slots located on the wall bracket and secure to the wall.

 **NOTE: DO NOT use countersunk screws. DO use fixings listed under “Tools and Fittings Required” section for solid walls. DO NOT enlarge fixing slots, this can reduce the strength of the bracket and invalidate the safe working load stated.**

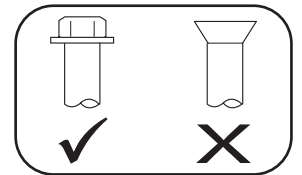

7. If stainless steel fixings are not used, apply silicone sealant around the screw heads and washers to avoid corrosion.
8. Once secured in position, clip the cover plate over the wall bracket to conceal the wall fixings and complete the assembly of the shower seat - See Fig.2
9. Always check the shower seat is securely fastened to the wall before use.

Fig.1

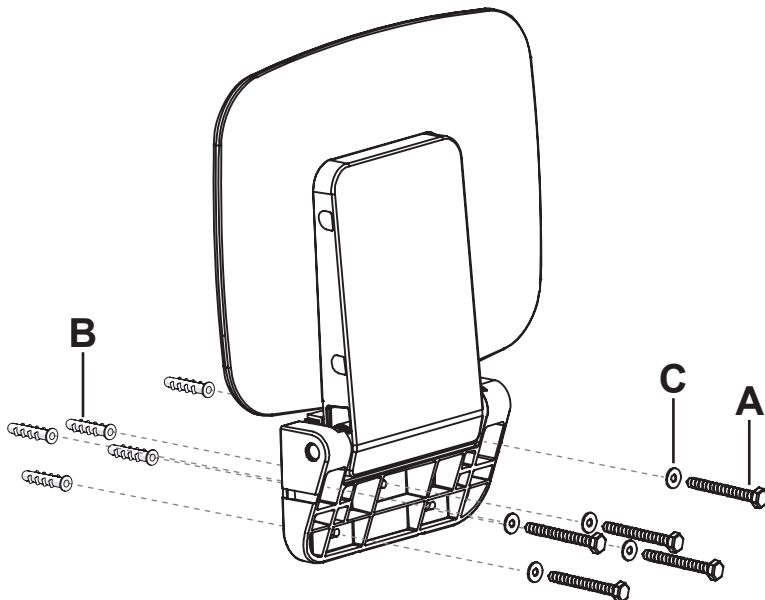
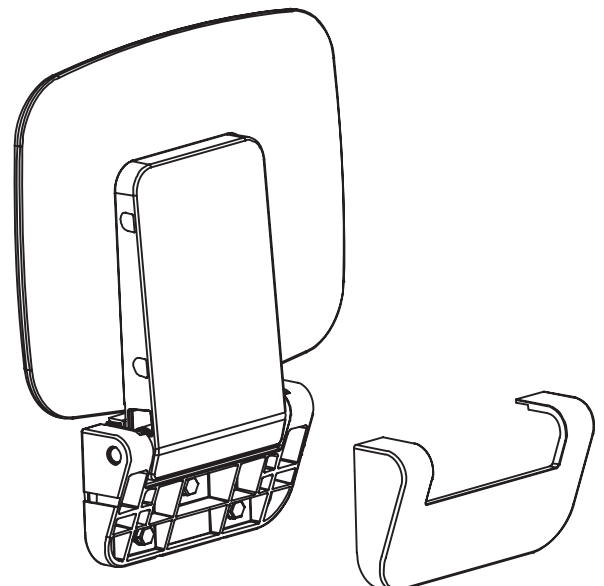

Fig.2



NOTE: All fixing slots must be used!

UK: Croydex Ltd, Central Way, Andover, Hants, SP10 5AW, UK

EU: MIL, Unit 8 Purcellsinch Ind Est, Dublin Road, Kilkenny, R95 HP71, Ireland

Tel: +44 (0) 1264 365881

Fax: +44 (0) 1264 356437

Email: info@croydex.co.uk