

Ensure the earth bonding complies with relevant regulations.

L (Live) = Brown wire
⊕ (Protective Earth) = Green /Yellow sleeved wire
N (Neutral) = Blue wire

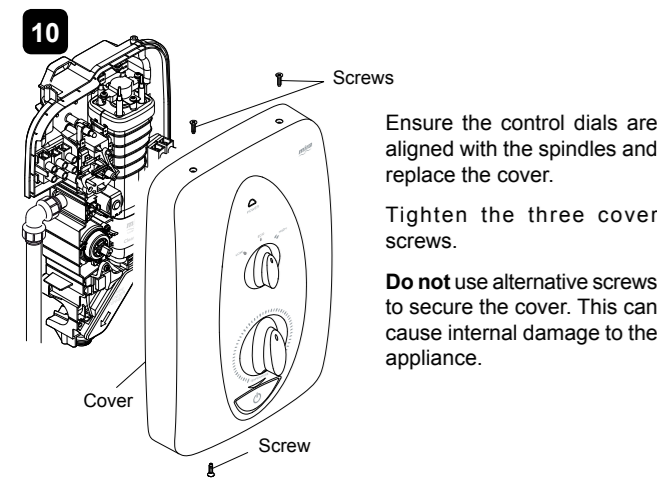

- 11** Install the shower fittings (Refer to the Shower Fittings Installation and User Guide packed with the product).
- 12** The shower must be commissioned before use, please refer to section: 'COMMISSIONING'.
- 13** This completes the installation.

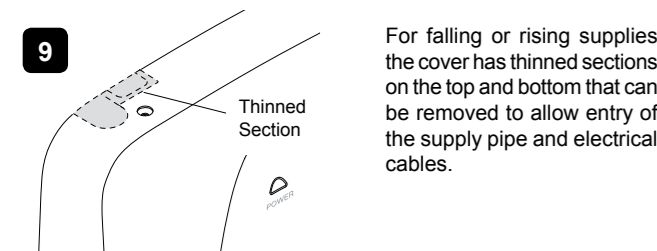
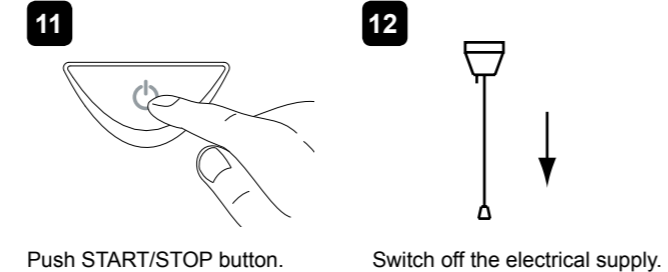
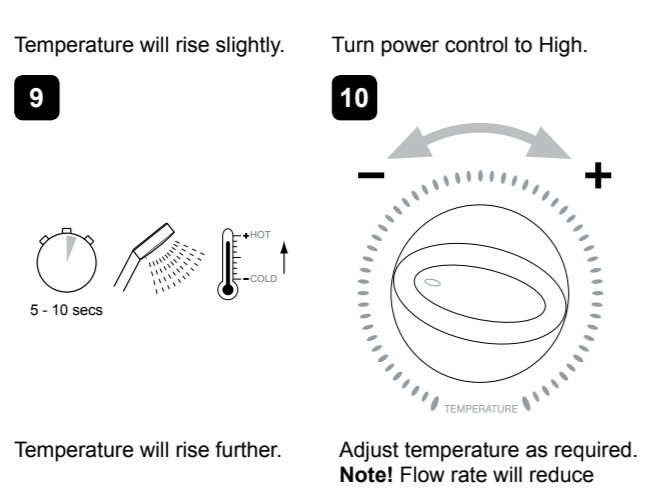
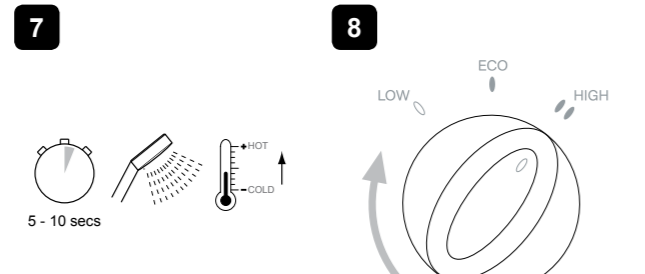
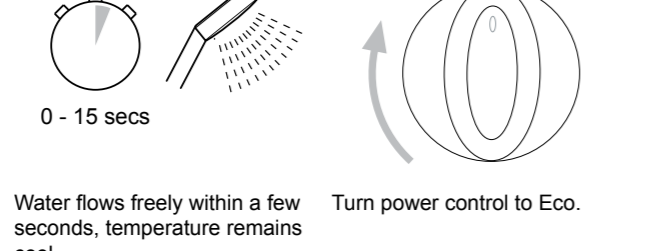
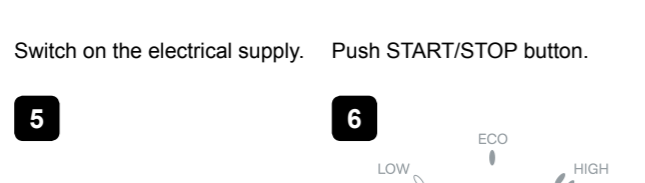
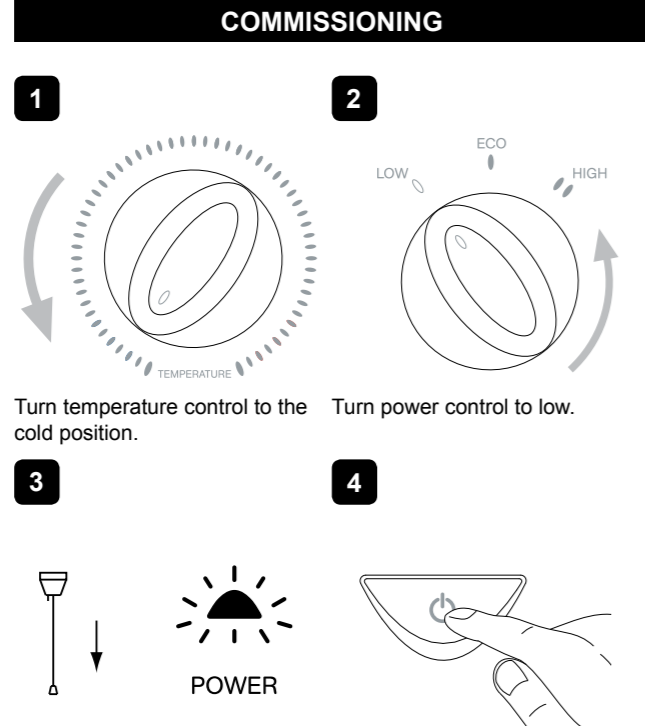

13 A small amount of water may continue to drain over a few minutes.

Note! A slight hissing sound may be heard from the shower during operation. High mains water pressure and high shower temperatures will affect the tone. This is quite normal in use.

FAULT DIAGNOSIS

Warning! There are no user serviceable components beneath the cover of the appliance. In the event of a malfunction of the shower, the troubleshooting information below provides details on possible causes and remedies that may be carried out by qualified, competent personnel. Non-qualified personnel should refer to the fault diagnosis section in the users guide.

Symptom	Possible Cause	Possible Remedy
No hot water from the shower, with the controls in ECO/HIGH position	Insufficient water supply pressure	Contact local water authority
	Failure of the microswitch or thermal switch	Check the continuity of the switches, using a suitable continuity measuring device. Replace the switches as necessary
	An internal wiring connection has failed	Check the integrity of the internal wiring
	One of the heater tank elements has failed	Replace the heater tank assembly
The shower temperature cycles between hot and cold with power control in ECO/HIGH	Switch assembly fault	Replace On / Off switching assembly
	The hose or showerhead is blocked	De-scale showerhead, check hose for kinks or damage and replace if necessary. Refer to the User Maintenance section of the user guide
The shower temperature does not affect the water temperature	The temperature is set too high. This is causing the thermal switch to turn off the heating element to reduce the water temperature	Turn the temperature control anticlockwise to reduce the water temperature or turn the power control to ECO. DO NOT TAMPER with the thermal switch
	The hose or showerhead is blocked	De-scale showerhead, check hose for kinks or damage and replace if necessary. Refer to the User Maintenance section of the user guide
Turning the temperature control does not affect the water temperature	The flow regulator is faulty	Replace the heater tank assembly
	The hose or showerhead is blocked	De-scale showerhead, check hose for kinks or damage and replace if necessary. Refer to the User Maintenance section of the user guide
No water or very low flow rate	The hose or showerhead is blocked	De-scale showerhead, check hose for kinks or damage and replace if necessary. Refer to the User Maintenance section of the user guide
	The incoming water supply stop valves, or the appliance isolating valve is closed	Open the stop/isolating valve completely
	Insufficient water supply pressure	Contact the local water authority
Power LED does not illuminate when the pull cord is operated	Electrical supply failure (MCB, pull cord etc.)	Check electrical supply
	Power LED faulty	Replace the wiring loom

No water or very low flow rate	The heater tank is excessively scaled	Replace the heater tank assembly
	The inlet filter is blocked	Clean the inlet filter
	The fuse is blown or the MCB / RCD has been tripped, indicating a possible electrical fault; for example, heater tank element failure	Switch on the power at the double pole switch
	The on / off switching assembly is faulty	Replace on / off switching assembly
	The start / stop switch is faulty	Replace start / stop switch
Water leaks from the bottom of the case near the outlet and there is no flow from the showerhead	The pressure relief valve in the tank has been triggered (usually due to a blocked outlet), when the relief valve operates a small rubber ball is ejected	Resolve the blocked outlet and replace the heater tank assembly
	The solenoid coil is faulty	Replace solenoid coil
The water cannot be turned off	The on / off switching assembly is faulty	Replace on / off switching assembly
	The start / stop switch is faulty	Replace start / stop switch
	The supply pressure is below the minimum required	Check the static water pressure. Note that the static water pressure may fall below the minimum requirement when other appliances are drawing water, for example the dishwasher or the washing machine

SERVICING

WARNING
There are no user serviceable parts inside the shower. Servicing of the shower must only be carried out by qualified, competent personnel following the instructions provided in this guide and those provided with any spare part. Before replacing any parts, ensure that the underlying cause of the malfunction has been resolved.

Cleaning the Inlet Filter
Warning! Isolate the electrical and water supplies before removing the cover.
 Remove the cover.

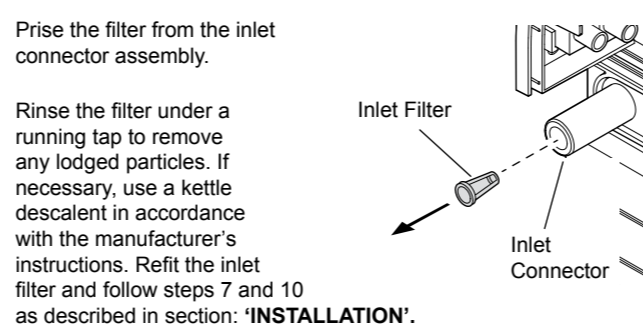
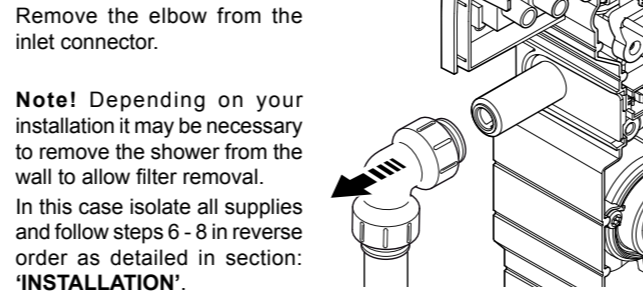

Note! If the shower was removed from the wall, steps 6, 7, 8 and 10 will need to be followed as described in section: 'INSTALLATION'.

Follow the steps detailed in section: 'COMMISSIONING' to prepare the shower for use.

ACCESSORIES

Genuine Mira accessories can be purchased direct from Customers Services (our contact details can be found on the back cover of this guide) or from approved stockists or merchants.

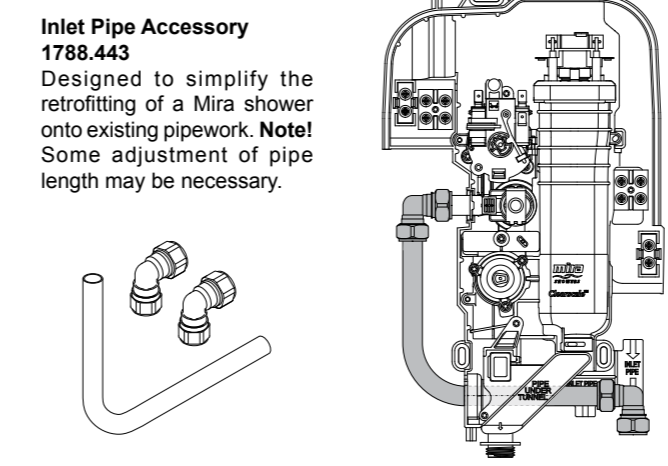

WIRING DIAGRAM

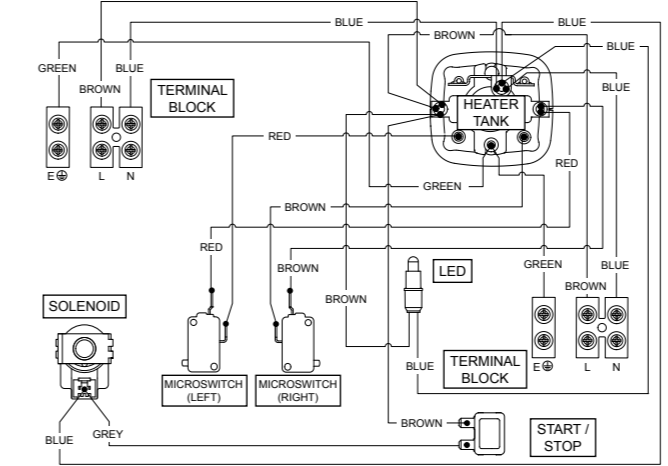

SPARE PARTS

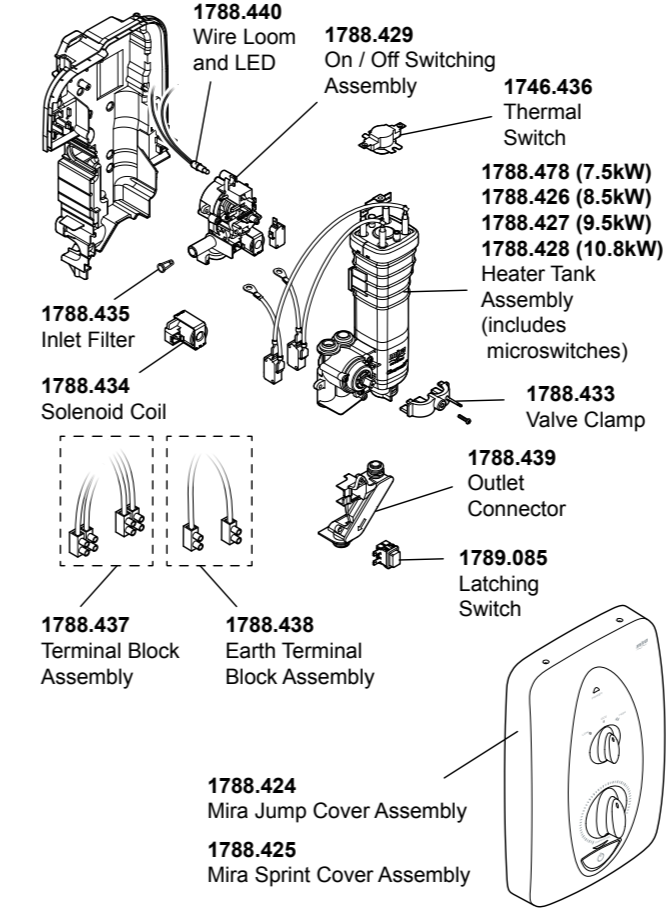

- 1693.331 Component Pack (Not illustrated)
- 1788.436 Screw Pack (Not illustrated)

CUSTOMER SERVICE

Guarantee
 Your product has the benefit of our manufacture's guarantee which starts from date of purchase. This guarantee only applies in the United Kingdom and Republic of Ireland. To activate this guarantee, please return your completed registration card, visit our website or free phone 0800 0731248 within 30 days of purchase (UK only).

Within the guarantee period we will resolve defects in materials or workmanship, free of charge, by repairing or replacing parts or product as we may choose.

This guarantee is in addition to your statutory rights and is subject to the following conditions:

- The guarantee applies solely to the original installation under normal use and to the original purchaser only. The product must be installed and maintained in accordance with the instructions given in this guide.
- Servicing must only be undertaken by us or our appointed representative. **Note!** If a service visit is required the product must be fully installed and connected to services.
- Repair under this guarantee does not extend the original expiry date. The guarantee on any replacement parts or product ends at the original expiry date.
- For shower fittings or consumable items we reserve the right to supply replacement parts only.

The guarantee does not cover:

- Call out charges for non product faults (such as damage or performance issues arising from incorrect installation, improper use, inappropriate cleaning, lack of maintenance, build up of limescale, frost damage, chemical attack, corrosion, system debris or blocked filters) or where no fault has been found with the product.
- Water or electrical supply, waste and isolation issues.
- Compensation for loss of use of the product or consequential or indirect loss of any kind.
- Damage or defects caused if the product is repaired or modified by persons not authorised by us or our appointed representative.
- Accidental or wilful damage
- Products purchased ex-showroom display.

What to do if something goes wrong
 If your product does not work correctly refer to this manual for fault diagnosis and check that it is installed and commissioned in accordance with our instructions. If this does not resolve the issue, contact us for help and advice.

Extended Guarantees
 A selection of protection plans are available that enable you to cover repair bills (excludes Eire). Ring 01922 471763 for more details.

Helpdesk Service - Contact our Customer Services Team for product advice, to purchase spare parts or accessories or to set up service visit. You can contact us via phone or e-mail - contact details below. Please provide your model name, power rating (if applicable) and date of purchase.

Mira Showers Website (www.mirashowers.co.uk)
 Visit our website to register your guarantee, download user guides, diagnose faults, purchase our full range of accessories and popular spares, or request a service visit.

Spares and Accessories - We hold the largest stocks of genuine Mira spares and accessories. Contact us for a price or visit our website to purchase items from our accessory range and popular spares. (Only available in the United Kingdom).

Service/Repairs - No one knows our products better than our nationwide team of Service Technicians. We can carry out service or repair work to your product both during and after the guarantee period (Only available in the United Kingdom and Republic of Ireland). Ask about our fixed price service repairs.

To Contact Us
0844 571 5000

Fax: 01242 282595

E-mail:
www.mirashowers.co.uk/contactus
 Mira Customer Services Dept
 Cromwell Road, Cheltenham,
 Gloucestershire
 GL52 5EP

To Contact Us: Eire Only
01 531 9337

E-mail:
CustomerServiceEire@mirashowers.com

Mira is a registered trade mark of Kohler Mira Limited.

The company reserves the right to alter product specifications without notice.

BSI
 FM 14648
mira
 SHOWERS

© Kohler Mira Limited, May 2017

Mira Jump
 7.5, 8.5, 9.5 and 10.8 kW Electric Shower

Mira Sprint
 8.5, 9.5 and 10.8 kW Electric Shower

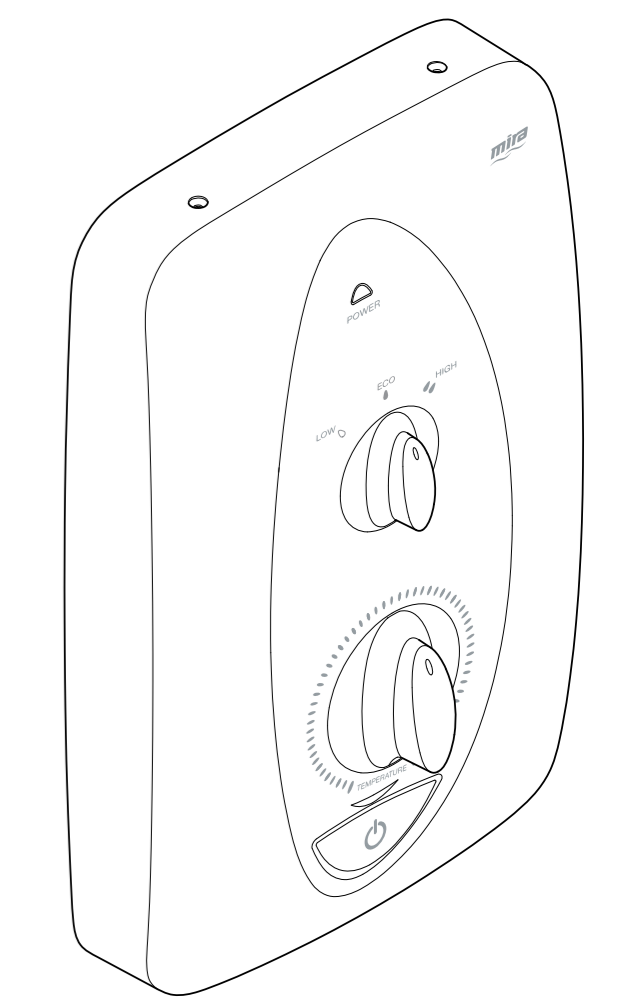

These instructions must be left with the user

INTRODUCTION

Thank you for choosing a Mira shower. To enjoy the full potential of your new shower, please take time to read this guide thoroughly, and keep it handy for future reference.

Products manufactured by Kohler Mira Ltd are designed to be safe, provided that they are installed, used and maintained in good working order, in accordance with our instructions and recommendations. Follow all warnings, cautions and instructions contained in this guide, and on, or inside the shower. This guide is also available in electronic format on our website or by contacting customer services.

This product has separate controls for power selection and for temperature/flow adjustment. A unique flow regulator stabilises any temperature changes caused by water pressure fluctuations, which can result from taps being turned on or off or toilets being flushed.

 Electrical and electronic devices contain a range of materials that can be separated for recycling and used in new products.

This shower should not be disposed of with your general household waste. When this shower has reached the end of its serviceable life please take it to a recognised WEEE (Waste Electrical and Electronic Equipment) collection facility such as your local civic amenity site for recycling.

Your local authority or retailer will be able to advise you of your nearest collection facility.

Mira Electric Showers covered by this guide:

Product	kW	Model Number	Colour
Mira Jump	7.5	J08 Hb	White / Chrome
	8.5	J08 Db	
	9.5	J08 Eb	
10.8	J08 Fb		
Mira Sprint	8.5	J08 Da	
	9.5	J08 Ea	
	10.8	J08 Fa	

Guarantee

This product has been designed for domestic use only, Mira Showers guarantee this product against any defect in materials or workmanship for a period of two years from the date of purchase (shower fittings for one year).

For terms and conditions, refer to the back cover of this guide.

Recommended Usage

Domestic	✓
Light Commercial	✓
Heavy Commercial	✗
Healthcare	✗

IMPORTANT SAFETY INFORMATION

WARNING – This shower can deliver scalding temperatures, cause fire, electric shock or other personal injury if not installed, operated or maintained in accordance with the instructions, warnings and cautions contained in this guide and on or inside the appliance.

Please read the important safety information and the installation requirements detailed in this guide before installing the shower. Failure to follow the instructions provided with this shower will invalidate the guarantee.

TO REDUCE THE RISK OF FIRE, ELECTRIC SHOCK OR INJURY:

- Installation of this shower must be carried out in accordance with these instructions by qualified, competent personnel.
- Isolate the electrical and water supplies before commencing installation. The electricity must be isolated at the consumer unit and the appropriate circuit fuse removed, if applicable. Mains connections are exposed when the cover is removed.
- DO NOT** install the shower in areas with high humidity and temperature (i.e. steam rooms and saunas).
- DO NOT** install the shower where it may be exposed to freezing conditions. Ensure that any pipework that could become frozen is properly insulated.

- DO NOT** switch the shower on if there is a possibility that the water in the shower is frozen.
- DO NOT** switch the shower on if water starts leaking from the shower case. Isolate the electrical supply to the shower immediately.
- DO NOT** connect the outlet of the shower to any tap, control valve, trigger operated handset or showerhead other than that specified for use with this shower. Only Kohler Mira recommended accessories should be used.
- The water supplies to this product must be isolated if the product is not to be used for a long period of time. If the product or pipework is at risk of freezing during this period they should also be drained of water.
- DO NOT** perform any unspecified modifications, or drill or cut holes in the product other than as instructed by this guide. When servicing only use genuine Kohler Mira replacement parts.
- If the shower is dismantled during installation or servicing then upon completion the product must be inspected to ensure all electrical connections are tight and that there are no leaks.
- Read all installation instructions before installing this shower.
- Upon completion of the installation, make sure that the user is familiar with the operation of the shower, and leave this guide and the user guide with the owner.

SPECIFICATION

Dimensions				
Height	356 mm			
Width	225 mm			
Depth	107 mm			

Plumbing	Variant			
	7.5	8.5	9.5	10.8
Min Dynamic Pressure	70 kPa (0.7 bar)	70 kPa (0.7 bar)	70 kPa (0.7 bar)	100 kPa (1.0 bar)
Max Dynamic Pressure	500 kPa (5.0 bar)			
Max Static Pressure	1000 kPa (10 bar)			
Min Static Pressure	50 kPa (0.5 bar)			
Max Inlet Temperature	30°C			
Min Inlet Temperature	2°C			
Inlet Connection	15 mm Compression / Pushfit Coupling			
Max Water Hardness	200 ppm CaCO ₃			
Outlet Connection	1/2" BSP Male			

Electrical	Variant			
	7.5	8.5	9.5	10.8
Nominal Power at 240 V ac	7.5 kW	8.5 kW	9.5 kW	10.8 kW
Nominal Power at 230 V ac	6.9 kW	7.8 kW	8.7 kW	9.9 kW
Recommended MCB Rating	32 A	40 A	40A	45 A
Max Supply Cable Size	16 mm ²			
Recommended RCD Rating	30 mA tripping current			
Recommended Isolator Switch	45 A double-pole with 3 mm contact separation			
Appliance Sealing Rating	IP X4 - Suitable for installation in Zone 1			
Max Ambient Temperature	30°C			
Min Ambient Temperature	2°C			

European Conformity Information

This range of electric showers complies with the following European directives:

2006/95/EC Low Voltage Directive, 2004/108/EC EMC Directive, 2011/65/EU RoHS Directive

This range of electric showers are high power appliances and are subject to conditional connection. If the main electrical supply fuse is rated less than 80 Amps, the local electricity supply company must be contacted to confirm if the electrical supply is adequate.

This range of showers complies with the requirements of the UK's water regulations.

PACK CONTENTS

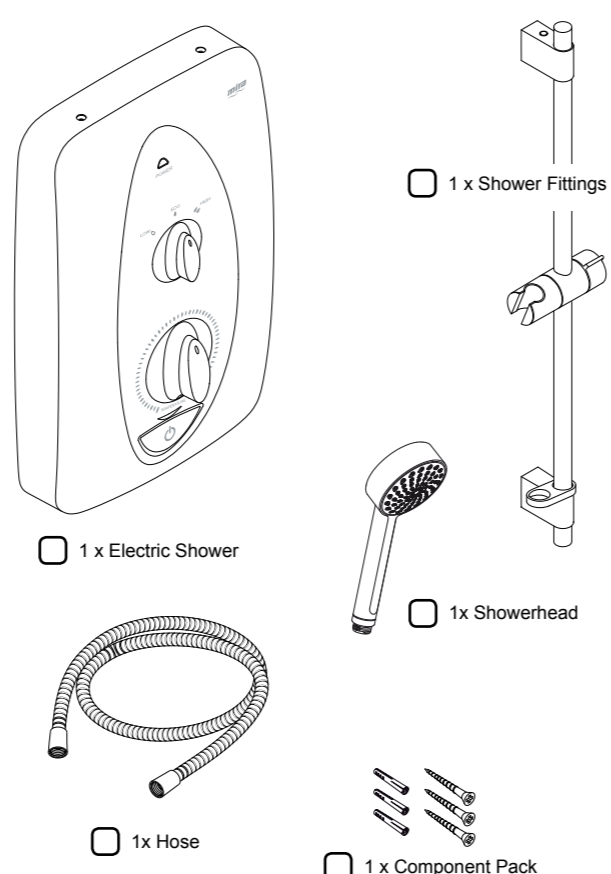

Documentation

- 1 x Guarantee Brochure
- 1 x Installation Template (printed on the inside of product carton)
- 1 x Installation Guide
- 1 x User Guide

INSTALLATION REQUIREMENTS

PLUMBING

- The plumbing installation must comply with all national or local water regulations and all relevant building regulations, or any particular regulation or practice specified by the local water supply company.
- Do not install the product in a position in which service access is limited.
- Decide on a suitable position for the shower (minimum distance of 200 mm from the ceiling to allow for cover fit and removal). The shower is suitable for installation within the shower area and is fitted with a pressure relief valve. It must be positioned over a water catchment area with the controls at a convenient height for the user.
- The shower must be fitted to a waterproof flat and even wall surface.
- DO NOT** fit the shower to the wall and tile up to the case.
- DO NOT** seal the gap between the shower and the wall surface.
- The showerhead should be positioned so that it discharges down the centre line of the bath or across the opening of a shower cubicle.
- The showerhead must be directed away from the shower unit, during normal use the showerhead must not spray directly on to the shower unit.
- DO NOT** apply excessive force to plumbing connections; always provide mechanical support when making plumbing connections. Any soldered joints should be made before connecting the shower.
- The position of the shower and shower fittings must provide a minimum gap of 25 mm between the showerhead and the spill over level of any bath, shower tray or basin and a minimum gap of 30 mm between the showerhead and the spill over level of any toilet, bidet or other appliance with a Fluid Category 5 backflow risk.

Note! There will be occasions when the hose retaining ring will not provide a suitable solution for Fluid Category 3 installations, in these instances an outlet double checkvalve must be fitted, this will increase the required supply pressure typically by 10kPa (0.1 bar). Double checkvalves fitted in the inlet supply to the appliance cause a pressure build up, which affect the maximum static inlet pressure for the appliance and must not be fitted. For Fluid category 5 double checkvalves are not suitable.

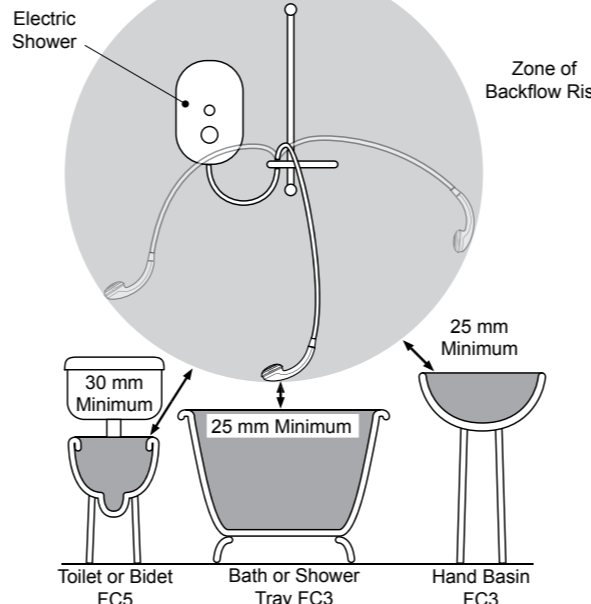

Hose retaining ring fitted and shower fittings fixed at a suitable height preventing dirty water backflow.

- This shower is not designed to be plumbed directly from the rear. For rear-entry supply, add an elbow to the supply pipe and connect as a rising or a falling supply.
- If pipework and/or electrical cables enter the shower from the rear through a hole in the wall provision must be made to prevent water ingress back into the wall structure.
- This shower is intended to be permanently connected to the mains water supply, only use the inlet connection supplied with the shower.
- DO NOT** use any other type of fitting.
- A full bore/non restrictive servicing valve must be fitted in a readily accessible position adjacent to the shower to facilitate maintenance of the shower. **DO NOT** use a valve with a loose washer plate (jumper) as this can lead to a build up of static pressure.
- A water treatment device should be installed where the water hardness may exceed 200 ppm. Malfunctions caused by excessive limescale formation are not covered by this shower's guarantee (see back page for details).
- The installation must not cause the hose to be sharply kinked during normal use.
- DO NOT** perform the electrical installation until the plumbing has been completed and checked for leaks.

ELECTRICAL

- The electrical installation must comply with BS 7671 (commonly referred to as the IEE Wiring Regulations) and all relevant building regulations, or any particular regulation or practice specified by the local electricity supply company.
- Ensure that all circuit protection devices, switches and cabling is adequate for the rated current of the shower and that the rating of the electricity supply company fuse and the consumer unit are adequate for the additional demand.
- The shower **must** be earthed. Ensure any supplementary bonding complies with the relevant regulations.
- This shower is intended to be permanently connected to the fixed electrical wiring of the mains system. A separate supply **must** be provided from the consumer unit to the shower.
- DO NOT** supply any other electrical equipment including extractor fans or pumps via this product.
- This shower must be provided with means for local disconnection that is incorporated into the fixed wiring in accordance with the relevant local wiring regulations. This **must** be a double pole switch, which has at least 3 mm contact separation in each pole. The switch can be a ceiling mounted pull-cord type within the shower room or a wall mounted switch fitted in the applicable zone area.
- For new installations a 30mA Residual Current Device (RCD) must be incorporated into the electrical supply to this shower in accordance with current wiring regulations. When replacing an existing electric shower we recommend that a 30mA RCD be incorporated in accordance with current wiring regulations if not already provided.
- DO NOT** apply excessive force to the terminal block.
- All electrical connections should be checked for tightness to prevent overheating before switching on the electrical supply.

- DO NOT** switch on the electrical supply until the plumbing has been completed and checked for leaks.

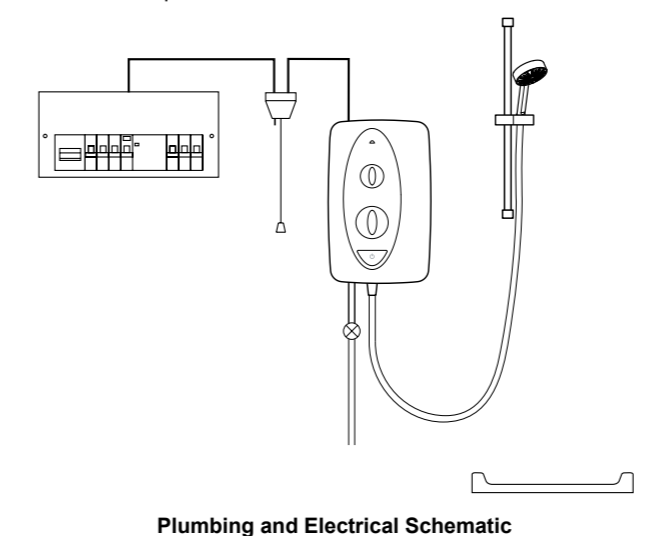

INSTALLATION

Fitting a New Shower

Warning! Isolate the electrical and water supplies before installing the shower.

- Use the Installation Template provided (printed on the product carton), together with a spirit level to mark the positions of the **three** fixing holes.
- Note!** The shower should be positioned at least 200 mm from the ceiling. Ensure that there are sufficient lengths of supply pipe and electrical cable to reach the connection points as shown on the template.
- Drill three holes to suit the fixing screws and wall plugs.
- Caution!** Do not drill into cables or pipes in the wall.
- Remove the three screws that hold the cover on and remove the cover.
- Determine the direction and route of the incoming water supply:

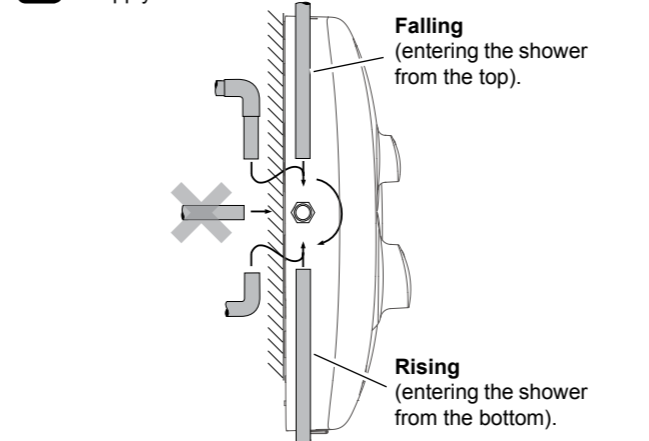

Note! - **DO NOT** use an incoming supply entering the shower directly from the back. Add an elbow to the supply pipe and connect it as a rising or falling supply.

- Thoroughly flush the supply pipe.**
- Secure the shower to the wall with fixing screws and wall plugs (supplied) or appropriate wall fixings for your installation.

7

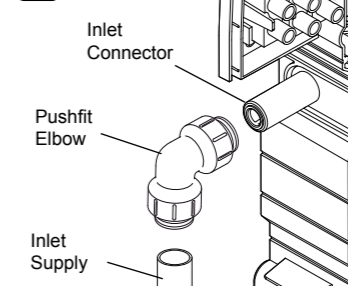

Connect the inlet supply pipe to the inlet connector using a push fit elbow or an elbow with compression nuts and olives.

Important! Do Not use pushfit elbows that require specialist tools for removal. Access to the inlet filter is required periodically and so any connector needs to be easily removed for maintenance.

Note! When making connections to the shower. Do not use jointing paste products as damage to the shower will occur.

Turn on the water supply and check connection for leaks.

8

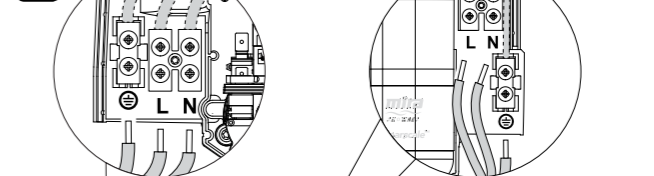

Terminal Blocks are provided on both the left and right for convenience. Use the terminal block location that is most appropriate for your installation i.e. If the electric supply is on the right hand side then use the right hand terminal block.

Strip back sufficient outer cable insulation to enable routing to the terminal block.

Fit an earth sleeve to the earth wire.

Insert the wires into the terminal block.

Tighten the screws in the terminal block, ensure the wires are secure and tight.

9

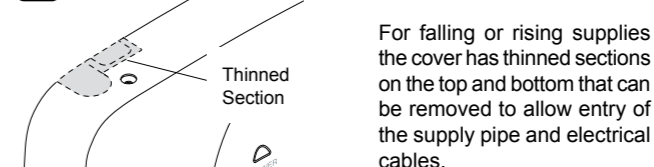

For falling or rising supplies the cover has thinned sections on the top and bottom that can be removed to allow entry of the supply pipe and electrical cables.

10

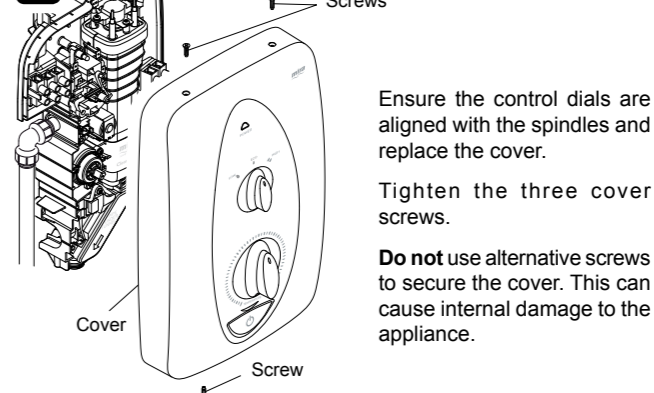

Ensure the control dials are aligned with the spindles and replace the cover.

Tighten the three cover screws.

Do not use alternative screws to secure the cover. This can cause internal damage to the appliance.

Do not seal around the back of appliance.

- The shower must be commissioned before use, please refer to section: '**COMMISSIONING**'.

13

This completes the installation.

Replacing an Existing Electric Shower

This electric shower can replace showers of approximate size and shape.

Terminal Blocks are provided on both the left and right for convenience when replacing a shower.

If the water entry point is on the right hand side of the shower then you will need to alter the incoming pipework as shown below. The Mira Inlet Pipe Accessory can be used to simplify this process. Refer to section: '**ACCESSORIES**'.

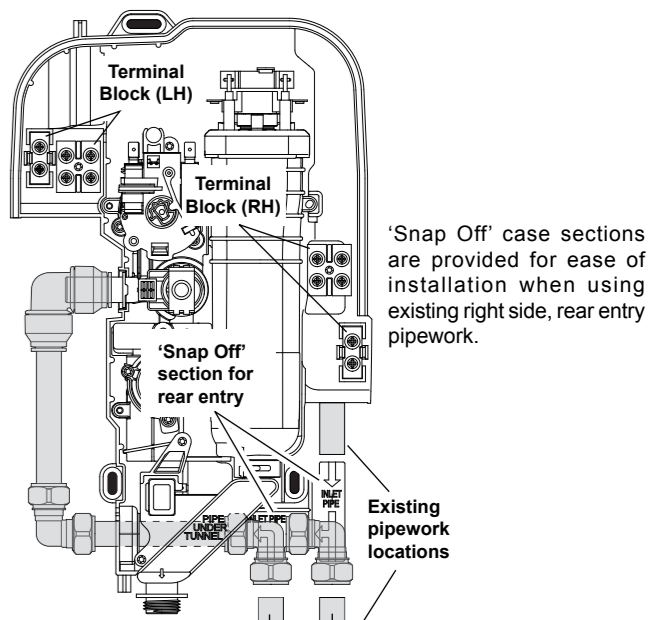

'Snap Off' case sections are provided for ease of installation when using existing right side, rear entry pipework.

Warning! Isolate the electrical and water supplies.

- Disconnect and remove the old shower from the wall.
- Place the shower on the wall where the previous shower was installed and mark the positions of the **three** fixing holes.
- Note!** Ensure that there are sufficient lengths of supply pipe and electrical cable to reach the connection points.
- Remove the shower and drill three holes to suit the fixing screws and wall plugs.

Caution! Do not drill into cables or pipes in the wall.

- Thoroughly flush the supply pipe.**
- Secure the shower to the wall with fixing screws and wall plugs (supplied) or appropriate wall fixings for your installation.
- Connect the inlet supply pipe to the inlet connector using a push fit elbow or an elbow with compression nuts and olives.
- Turn on the water supply and check connection for leaks.