

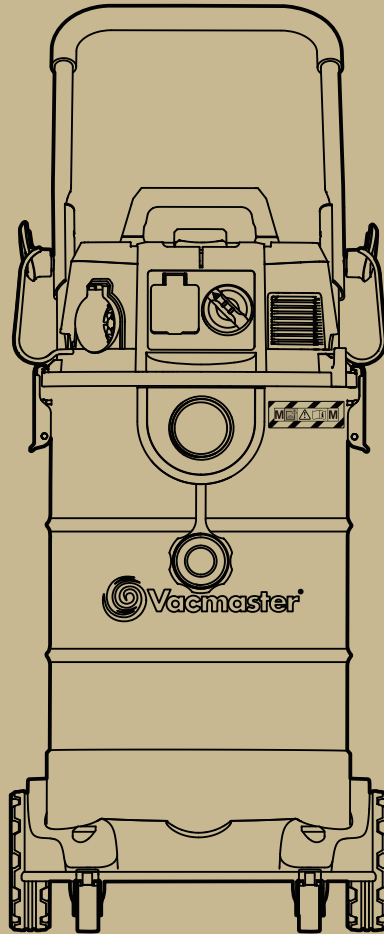

38L | 1500W
VDK1538SWC



ORIGINAL INSTRUCTIONS



IPX4

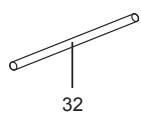
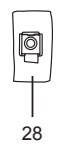
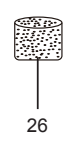
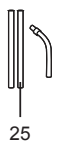
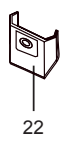
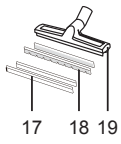
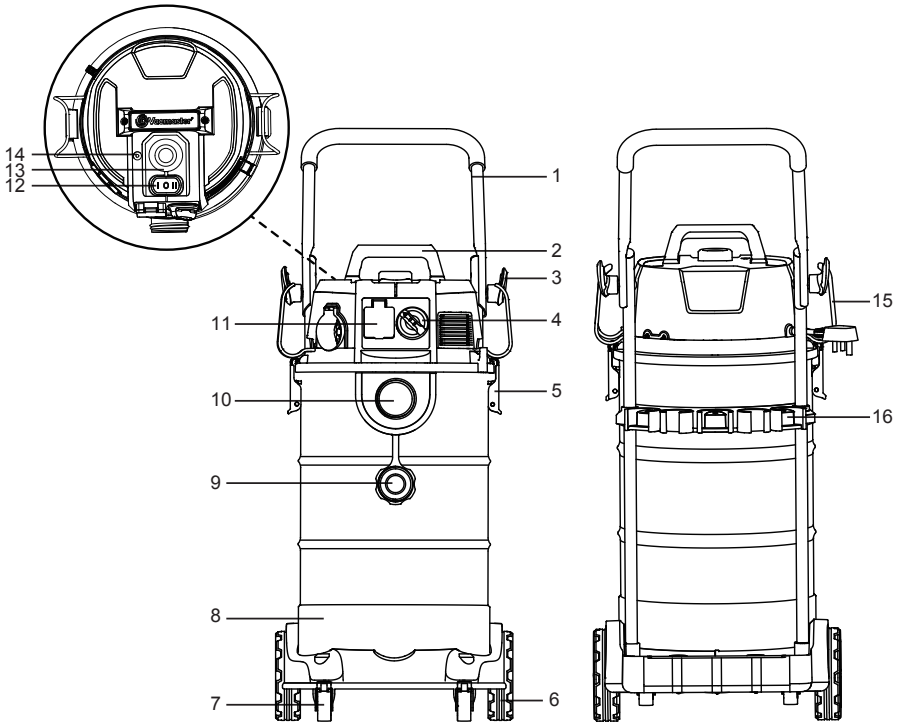





TABLE OF CONTENTS

SECTION	PAGE
Symbols.....	6
Safety Information	7
Unpacking and Checking Carton Contents	10
Assembly	11
Operation.....	12
Maintenance.....	15
Troubleshooting.....	16
Technical Data	17
Recycling and Disposal	17
Plug/Fuse Replacement (UK & Ireland Only).....	18

Thank you for purchasing this Vacmaster® wet and dry vacuum cleaner. Feel confident that with Vacmaster® you are obtaining a high quality product engineered for optimal performance. This vacuum cleaner is suitable for use with both liquids and dry materials.

FOR YOUR SAFETY: CAREFULLY READ AND UNDERSTAND ALL INSTRUCTIONS.

SYMBOLS

	Caution
	Read instruction manual. Failure to follow the warnings and instructions may result in electric shock, fire and/or serious injury.
	Vacuum cleaners of dust category M according to IEC/EN 60335-2-69 for dry vacuuming of hazardous dusts with an exposition limit value $\geq 0.1 \text{ mg/m}^3$.
	WARNING: The vacuum cleaner may contain materials that are hazardous to one's health. Have the emptying and maintenance, incl. the disposal of dust-collection container, carried out only by a specialist. Appropriate protective equipment is required. Do not operate the vacuum cleaner without the complete filter system. Otherwise there is danger to your own health.

SAFETY INFORMATION

READ AND UNDERSTAND ALL INSTRUCTIONS BEFORE USING THIS VACUUM CLEANER.

This machine is intended for commercial use, for example in hotels, schools, hospitals, factories, shops, offices and rental businesses. Any other use is considered as improper use. The manufacturer accepts no liability for any damage resulting from improper use. The risk for such improper use is borne solely by the user.

When using the equipment, a few safety precautions must be observed to avoid injuries and damage. Please read the complete operating manual with due care. Keep this manual in a safe place so that the information is always available. If you give the equipment to any other person, give them these operating instructions as well. We cannot accept any liability for damage or accidents which arise due to a failure to follow these instructions and the safety information.

- Never leave the appliance switched on unattended, if you leave the work area, switch the appliance off or unplug it from the power supply.
- Do not vacuum or use this vacuum cleaner near flammable liquids, gases or explosive vapours like gasoline or other fuels, lighter fluids, cleaners, oil-based paints, natural gas, hydrogen, or explosive dusts like coal dust, magnesium dust, grain dust or gun powder. Sparks inside the motor can ignite flammable vapours or dust.
- This vacuum cleaner is not suitable for the vacuuming of asbestos or asbestos dust.
- Do not vacuum anything that is burning or smoking, such as cigarettes, matches, or hot ashes.
- Ensure the hose and connections are always pointed away from the users face, hair, ears and eyes during operation and never direct the nozzle towards persons or animals.

- Clear the working area of any items or possessions that you do not wish to be vacuumed before operation.
- Keep cord away from heated surfaces.
- Do not expose to rain. Store indoors.
- Do not unplug by pulling on the cord. To unplug, grasp the plug, not the cord.
- Do not use with damaged cord, plug or other parts.
- Do not pull or carry by cord, use cord as handle, close a door on cord, or pull cord around sharp edges or corners.
- Do not handle the plug or vacuum cleaner with wet hands.
- Frequently check that the float valve positioned underneath the motor is able to move freely.
- Do not use this vacuum cleaner with a torn filter or without the filter installed.
- Do not allow to be used as a toy. Close attention is necessary when used by or near children.
- To reduce the risk of injury from accidental starting, unplug power cord before changing or cleaning filter.
- Unplug from power supply when not in use and before carrying out maintenance.
- Do not cover the ventilation openings. Do not vacuum with any ventilation openings blocked; keep free of dust, lint, hair or anything that may reduce air flow.
- Keep hair, loose clothing, fingers, all parts of body away from openings and moving parts.
- If the supply cord is damaged, it must be replaced by the manufacturer, a qualified service agent or similarly qualified persons in order to avoid a hazard.
- This machine is not intended for use by persons (including children) with reduced physical, sensory or mental capabilities, or lack of experience and knowledge.
- Children shall not play with the appliance.
- Cleaning and user maintenance shall not be made by children without supervision.
- For additional protection: It is recommended that this vacuum cleaner can be used in conjunction with residual current device (RCD) with a rated residual current of 30mA or less.
- Only use the socket outlet on the machine for purposes

specified in the instructions.

- If foam or liquid escapes from the machine, switch off immediately.
- Check the float valve regularly to ensure it is moving freely and examine it for signs of damage.
- Precautions should be taken when changing attachments.
- For user servicing, the machine must be dismantled, cleaned and serviced, as far as is reasonably practicable, without causing risk to the maintenance staff and others. Suitable precautions include decontamination before dismantling, provision for local filtered exhaust ventilation where the machine is dismantled, cleaning of the maintenance area and suitable personal protection.
- Perform a technical inspection at least annually, consisting of, for example, inspection of filters for damage, air tightness of the machine and proper function of the control mechanism.
- Besides the operating instructions and the binding accident prevention regulations valid in the country of use, observe recognized regulations for safety and proper use.
- When dust removers are used, the rate at which air is exchanged in the room must be adequate if the exhaust air from the vacuum cleaner is blown into the room (please observe regulations valid in your country).
- Before starting work, the operating staff must be informed on
 - use of the vacuum cleaner
 - risks associated with the material to be picked up
 - safe disposal of the picked up material.
- Before transporting the collection tank, close all the locks. Do not tilt the cleaner if there is liquid in the collection tank. Do not use a crane hook to lift the cleaner.
- For class M machines, the outside of the machine should be decontaminated and wiped clean or treated with sealant before being taken out of a hazardous area. All the machine parts shall be regarded as contaminated when removed from the hazardous area and appropriate action taken to prevent dust dispersal.
- When using an extension lead, check the minimum cross-sections of the cable:

Cable length	Cross section	
	< 16 A	< 25 A
up to 20 m	1.5 mm ²	2.5 mm ²
20 to 50 m	2.5 mm ²	4.0 mm ²



WARNING: When carrying out service or repair operations, all contaminated items which cannot be satisfactorily cleaned are to be disposed of; such items shall be disposed of in impervious bags in accordance with any current regulation for the disposal of such waste.

UNPACKING AND CHECKING CARTON CONTENTS

1	Push/Pull Handle	13	Filter Cleaning Button	25	Metal Extension Wand (x3)
2	Carry Handle	14	Air Flow Indicator	26	Foam Filter
3	Wing Knob	15	Hose Storage Rack	27	Cartridge Filter (pre-installed)
4	Power Regulator	16	Accessory Storage	28	Disposable Bag (x5)
5	Latch	17	Squeegee Inserts	29	Washer (x4)
6	Rear Wheel	18	Brush Inserts (pre-installed)	30	Hub Cap (x2)
7	Front Caster	19	Floor Nozzle	31	Wheel Retaining Pin (x2)
8	Container	20	Suction Hose	32	Wheel Axle
9	Cover Gasket	21	Crevice Tool	33	Screw (x2)
10	Suction Port	22	Dust Bag (x5)	34	Instruction Manual
11	Power Take-off Socket	23	Round Dust Brush		
12	On/Off Switch	24	Power Tool Hose Adaptor		

ASSEMBLY

NOTE: A Phillips screwdriver is required. 

1. Remove all the contents from inside of the vacuum cleaner container.
2. Attach the carry handle into the slots located on the top of the power head. Secure them with supplied screws (Fig. 1).
3. Turn the container upside down and insert the front feet with casters into the slots and apply pressure until they click into place (Fig. 2).
4. Insert the wheel axle into the rear wheel housing on the base. Insert a washer onto the axle followed by the rear wheel and another washer. Insert the wheel retaining pin into the hole on the end of the axle to lock into place. Push fit the hub cap onto the wheel. Repeat the same steps on the other end of the axle (Fig. 3).
5. To position the hose storage rack, insert one end into the channel on the side of the power head, making sure it is secured in place. Apply inward pressure to the other side and insert it into the opposite channel (Fig. 4).
6. Unfold the upper handle assembly into the upright position. The upper handle has two adjustable height positions. Secure in place by tightening the wig knobs clockwise (Fig. 5).
7. Your vacuum cleaner comes ready for dry vacuum cleaning with the cartridge filter pre-installed. If the cartridge filter is not installed, refer to page 13.
8. To maintain M-class certification this vacuum cleaner must be used with a disposable collection means. By removing the dust bag and disposable bag when collecting debris the user runs the risk of voiding vacuum cleaner certification.
 - 1) To use a dust bag, fully fit the dust bag flange onto the inlet stub (Fig. 6).
 - 2) To use a disposable bag, place the disposable bag into the container, and fully fit the disposable bag flange onto the inlet stub. Fold the top edge of the disposable bag over the rim of the container (Fig. 7).
 - 3) To use a disposable bag and a dust bag together, place the disposable bag into the container and fully fit the disposable bag flange onto the inlet stub, and fold the top edge of the disposable bag over the rim of the container, then fully fit the dust bag flange onto the inlet stub (Fig. 8).
9. For wet vacuum cleaning, replace the cartridge filter with the foam filter supplied. Do not use a dust bag and/or a disposable bag when wet vacuuming. If the foam filter is not installed, refer to page 14.
10. Secure the power head back on the container using the latches. Insert the locking end of the hose into the suction port of the container and turn clockwise to lock into place (Fig. 9).
11. Choose the desired accessories and/or extension wands and push fit onto the hose nozzle.

Floor Nozzle Attachments

The floor nozzle comes supplied with additional attachments to ensure correct suction across different floor surfaces and applications.

- 1) To remove the floor nozzle attachments, turn the floor tool holder upside down.
- 2) Using a flathead screwdriver or other suitable tool, locate the holding clips on each outer edge. Insert a flat edged object directly next to the holding clip, between the insert and the floor tool

holder. Pry the attachment up from underneath (Fig. 10 & 11).

3) Insert the new attachments into the holder applying downwards pressure (Fig. 11).

4) The attachments can be used in three combinations (Fig. 12):

Brush and Squeegee Combination: For use with mixture of wet or dry liquids.

Dual Brush Combination: For use with dry materials or carpeted floor surfaces.

Dual Squeegee Combination: For use on hard floor with wet liquids.

NOTE: The textured side of the rubber squeegee must be facing outwards.

OPERATION

1. Switching On/Off

Connect the mains plug to a suitable power outlet.

Position	Status
I	on
O	off
II	automatic synchronized start-up



2. Power Tool Take-Off Operation (Fig. 13)



WARNING: Always check the maximum wattage compatibility of the power tool take off socket against the desired power tool before connecting to prevent overloading.

- 1) Connect the power cable of your power tool to the power take-off socket.
- 2) If applicable, connect the vacuum suction hose to the dust extractor connector on your tool with the supplied adaptor.
- 3) Switch the vacuum cleaner to position II, as described in Switching ON/OFF. The moment you switch on the power tool, the vacuum cleaner will also switch on. Once the electrical appliance has been switched off, the vacuum cleaner switches off following a time lapse (around 5 seconds) to allow the suction tube to be emptied.

3. Power Regulator

The airflow can be continuously adjusted by turning the power regulator (Fig. 14).

MIN: Reduced suction for applications which generate a low level of dust.

MAX: Maximum suction performance for use in applications which generate a high level of dust.

4. Filter Cleaning Operation

IMPORANT: Only perform the filter cleaning operation when the cartridge filter is installed.

After continuous dry vacuuming operation, air flow will decrease due to heavy accumulation of material and debris on the cartridge filter. This vacuum is equipped with integrated filter cleaning to increase dust collection efficiency.

When reduction of air flow ($\leq 20\text{m/s}$) has occurred during operation, the air flow indicator next to the filter cleaning button located on top of the power head will admit a flashing red LED. If the suction performance diminishes, you can improve the suction power with the help of the filter cleaning system (Fig. 15).

- 1) Position the end of the suction hose nozzle into the channel located within the filter cleaner button.
- 2) Move the on/off switch to the "I" position.
- 3) Turn the power regulator to the MAX position.
- 4) Press the filter cleaning button down and hold it down for 3-4 seconds (Fig. 16).
- 5) Repeat the process two more times.

5. Wet & Dry Vacuum Operation



WARNING: ENSURE YOU READ, UNDERSTAND AND APPLY SECTION ENTITLED 'SAFETY INFORMATION'.



WARNING: DO NOT VACUUM IN AREAS WITH FLAMMABLE GASES, VAPOURS, OR EXPLOSIVE DUSTS IN THE AIR. FLAMMABLE GASES OR VAPOURS INCLUDE BUT ARE NOT LIMITED TO; LIGHTER FLUID, SOLVENT TYPE CLEANERS, OIL-BASE PAINTS, GASOLINE, ALCOHOL OR AEROSOL SPRAYS. EXPLOSIVE DUSTS INCLUDE BUT ARE NOT LIMITED TO; COAL, MAGNESIUM, GRAIN OR GUN POWDER.

- 1) Verify that the correct filter is installed and the container latches are secured.
- 2) Secure the locking end of the hose into the vacuum suction port.
- 3) Push the desired accessories onto the hose nozzle. The air flow regulation allows you to change vacuum cleaner suction. For best cleaning results, fully close the air flow regulation (Fig. 17).
- 4) Plug the power cord into a power outlet.
- 5) Turn on the motor by assigning the switch to the "I" ON position.
- 6) Once you have completed vacuuming, switch to the "O" OFF position and unplug the power cord from the power outlet.

For Dry Vacuuming:



WARNING: BEFORE INSTALLING, REMOVING OR CLEANING THE VACUUM CLEANER FILTER, ENSURE THAT THE POWER CORD IS SWITCHED OFF AND UNPLUGGED.



WARNING: ALWAYS USE A P2-RESPIRATOR WHEN VACUUMING HAZARDOUS DUSTS.





- 1) To prepare your vacuum cleaner for dry vacuuming, install the cartridge filter over the filter cage. Carefully push filter until it sits flush forming a tight seal. Tighten the filter retainer lock clockwise to secure against the internal filter cage (Fig. 18).
- 2) Install the dust bag and/or the disposable bag onto the suction port inlet. Refer to page 11 for installation instructions.

IMPORTANT: Before picking up dust with occupational exposure limit values:

Check that all the filters are present and properly fitted.

For safety reasons, a visual warning indicator will activate if the air flow in the suction hose drops to below 20 m/s.

Depending on how hazardous the dust is, the cleaner must be fitted with appropriate filters and collection means.

Dusts with OEL values ≥ 0.1 mg/m ³ (observe any additional national regulations) Wood dusts & concrete dusts.		Cartridge Filter + Disposable Bag	Cartridge Filter Order No.: 951557 Disposable Bag Order No.: 951558 Dust Bag Order No.: 951559 Purchase online at www.cleva-europe.com
		Cartridge Filter + Dust Bag	
		Cartridge Filter + Dust Bag+ Disposable Bag	
All dusts vacuuming must fit with cartridge filter.		Cartridge Filter	

IMPORTANT: Dispose of the dirt in accordance with legal regulations.

Remove the electrical plug from the socket before emptying after dry pick-up. After removing the suction hose from the machine, close the cover gasket.

NOTE: The requirements for the ingress degree (dust category M) have only been certified for dry vacuuming.

IMPORTANT: Check the filter regularly for optimal performance. An old or blocked filter will reduce suction performance.



WARNING: When using the disposable bag, be careful not to vacuum heavy or sharp objects. When removing the disposable bag, use a P2-respirator, and securely tie a knot in the disposable bag. Do not make contact with any sharp objects and then carefully dispose of in accordance with legal regulations.

For Wet Vacuuming:



Caution!

Never vacuum liquids without the water level limit system and foam filter in place.

NOTE: Empty the container before wet vacuuming.

- 1) To prepare your vacuum cleaner for wet vacuuming, release the retainer lock and remove the dry use cartridge filter.
- 2) Carefully install the supplied foam filter over the internal filter cage (①), making sure the whole cage is covered (Fig. 19).



WARNING: DO NOT USE DUST COLLECTION BAGS FOR WET VACUUMING.

IMPORTANT! The vacuum cleaner is equipped with a float valve (②) which is operational during wet suction (Fig. 20). The suction power decreases when the maximum filling level is reached.

When this happens, switch the vacuum cleaner off immediately, and empty the container.

MAINTENANCE



WARNING: REMOVE THE POWER CORD FROM THE POWER SUPPLY BEFORE CARRYING OUT ANY MAINTENANCE.



WARNING: ALWAYS USE A P2-RESPIRATOR WHEN REMOVING THE CARTRIDGE FILTER AFTER VACUUMING HAZARDOUS DUSTS.

- 1) Keep all safety devices, air vents and the motor housing free of dirt and dust. Use a soft, dry brush to clean the equipment regularly.
- 2) Clear all dirt or debris from the collection tank after each use. Allow to dry before replacing the power head.
- 3) Check the hose, attachments, and power cord to verify that they have not been damaged or any debris is trapped and blocking airflow.

1. Cleaning Cartridge Filter

IMPORTANT! After vacuuming hazardous dusts, it is recommended to dispose of the cartridge filter within a sealed bag and dispose of in accordance with legal regulations.

IMPORTANT! When manually cleaning the cartridge filter, be careful not to damage the filter.

- 1) Remove the cartridge filter and clean by gently tapping or brushing dirt off. Ensure you always use a P2-respirator and only do so in a well ventilated environment. For optimal performance it is recommended to replace the old filter with a new filter regularly.
- 2) If necessary, use a mild soap and water solution to wash cartridge filter and rinse with clean water. Allow the filters to air dry before re-installing.

2. Cleaning Foam Filter

Remove the foam filter and use a mild soap and water solution to wash and rinse with clean water (Fig. 21). Allow filter to air dry before installing and using again.

TROUBLESHOOTING



WARNING: TO REDUCE THE RISK OF ELECTRIC SHOCK-UNPLUG BEFORE TROUBLESHOOTING.

Cleaning Performance

Vacmaster vacuum cleaners are tested for endurance. If your motor is operating, then the most likely cause for a loss in suction is a blockage or an opening in the vacuum.

To maintain a high cleaning performance from your machine, it is important to replace or clean cartridge filters as necessary. Replace full dust collection bags to prevent performance drops. A performance drop with clean filters can only be caused by a blockage in the tools or the hose.

PROBLEM	POSSIBLE CAUSE	SOLUTION
The appliance does not work.	No power.	Check the power supply and fuse.
	Functional fault in the power cord, switch, or motor.	Have the damaged part checked by qualified personnel or contact the after sales helpline.
Dust is escaping from the motor cover.	The cartridge filter is missing or damaged.	Put in a cartridge filter or replace it.
	Misuse the foam filter when dry vacuuming.	Replace the foam filter with the cartridge filter.
Power tool take-off socket does not work.	Power tool wattage is not compatible with the power tool take-off socket.	Check the wattage is compatible with the power tool take-off socket.
	Incorrect operating mode selected.	Ensure the switch is moved into position II.
Low suction power and high operating noise / vibrations.	Dust bag or disposable bag is full.	Replace the dust bag or disposable bag.
	Suction nozzle, hose, or tank inlet is blocked.	Check the suction nozzle, hose, and tank inlet for obstructions.
	Cartridge filter is blocked.	Remove the cartridge filter and clean.
	Float valve has closed.	Empty the container of any liquid waste and ensure the float valve located underneath the filter is able to move freely.
	Power regulator switch is set to minimum.	Adjust variable power regulator.
The air flow indicator is still red flashing after completing filter cleaning operation.	Suction nozzle, hose, or tank inlet is blocked.	Check the suction nozzle, hose, and tank inlet for obstructions.
	The cartridge filter has been contaminated heavily.	Remove and clean or replace with a new filter.
	The container is full.	Empty the container.

TECHNICAL DATA

Model Number	VDK1538SWC
Motor	220-240V~ 50Hz
Power Input	1500W
Max. Power Consumption Of the Power Tool Take-Off Socket Outlet	1490W for BS Socket 2180W for VDE Socket
Tank Volume	38L
Net Weight	14.0kg
Max. Vacuum Pressure	25kPa / 250hPa
Max. Flow Rate	71L/s / 255.6m³/h
Bearing Capacity of Disposable Bag	11.0kg
Bearing Capacity of Dust Bag	12.0kg

Noise/Vibration Information

Noise emission values determined according to **EN 60335-2-69**.

Typically, the A-weighted sound pressure level of the power tool is <78 dB(A).

Uncertainty K = 3 dB. The noise level when working can exceed 80 dB(A).

Total vibration values ah (triax vector sum) and uncertainty K determined according to

EN 60335-2-69: $a_h < 2.5 \text{ m/s}^2$, $K = 1.5 \text{ m/s}^2$.

RECYCLING AND DISPOSAL



This marking indicates that this product should not be disposed with other household wastes throughout the EU. The machine must be delivered in rigid packaging to avoid damage during transportation. The packaging and the machine itself are manufactured from recyclable materials and should be disposed of accordingly.

PLUG/FUSE REPLACEMENT (UK & IRELAND ONLY)

This product is fitted with a non-rewirable plug. If the plug has to be changed, refer to the picture below.

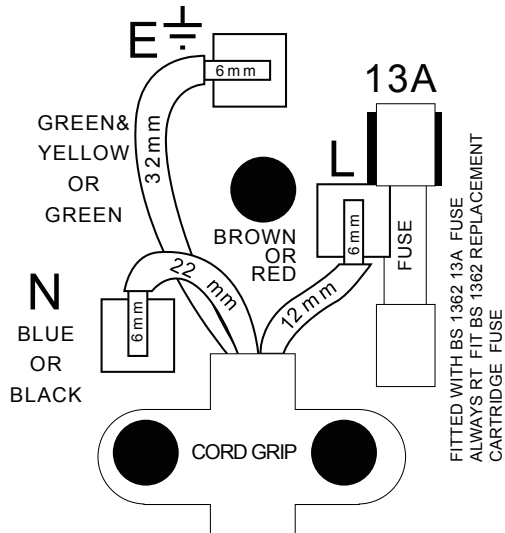

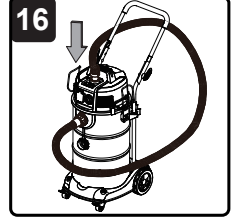
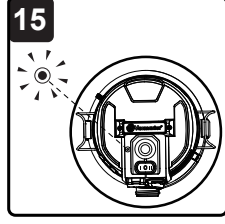
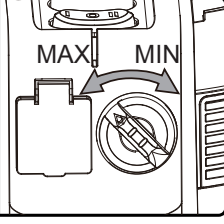
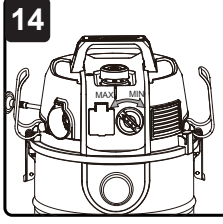
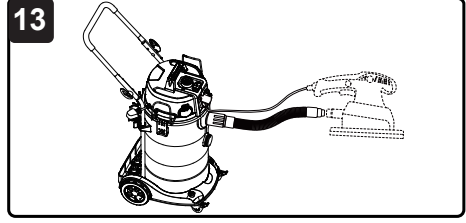
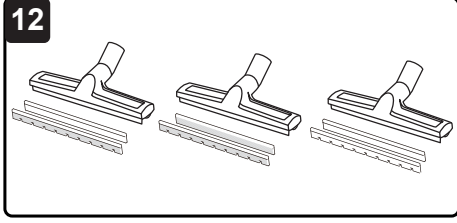
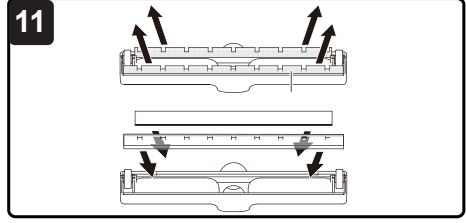
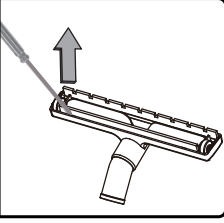
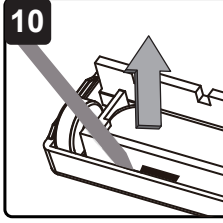
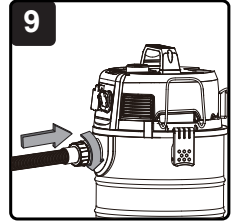
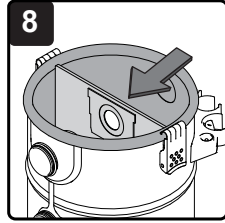
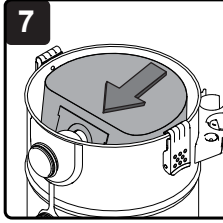
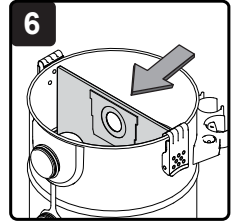
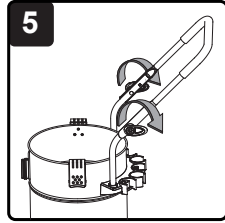
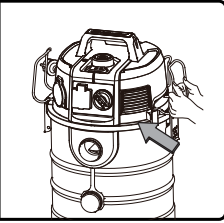
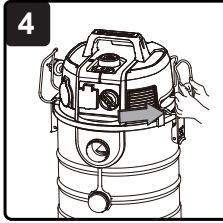
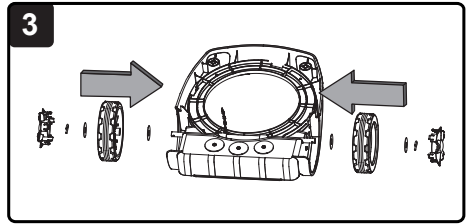
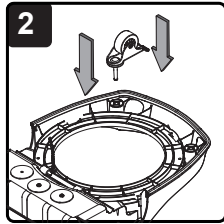
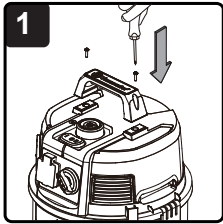

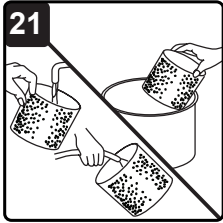
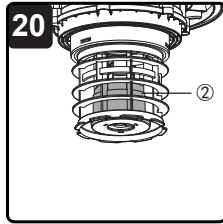
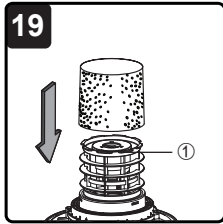
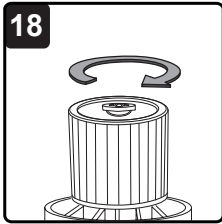
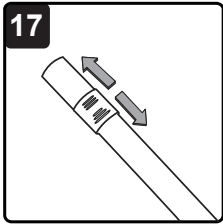

VDK1538SWC
Suzhou Cleva Electric Appliance Co., Ltd.
No.8 Ting Rong Street
Suzhou Industrial Park, Suzhou
Jiangsu Province, China
www.cleva-europe.com
Made in P.R.C