

KOBLE

www.kobledesigns.com

Bahamas Armchair

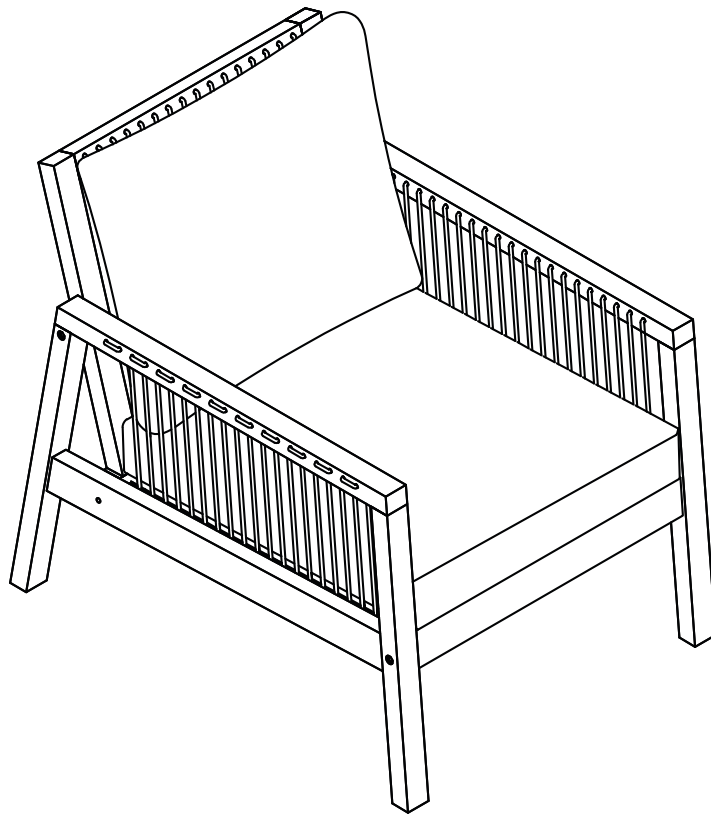

Care & Instruction Manual

Please read and retain these instructions for future reference

STOCK CODES : GFBAHC

Imported By: Koble Designs (Justwise Group Ltd). CB11 3AP.



Safety and Care Advice

Important – Please read these instructions fully before

Check you have all the components and tools listed on pages 3 and 4.

Remove all fittings from the plastic bags and separate them into their groups.

Small parts could choke if swallowed, keep children and animals away from work area.

Make sure you have enough space to layout the parts before starting.

Assemble the item as close to its final position (in the same room) as possible.

Assemble on a soft level surface to avoid damaging the unit or your floor.

Assembly requires 2 people.

Do not fully tighten bolts until the whole bed is assembled. Do not overtighten the nuts to avoid causing damage to the threads.



We do not recommend the use of power drill/drivers **for inserting screws,**

as this could damage the unit. Only use hand screwdrivers and Allen keys.

Dispose of all packaging carefully and responsibly.

Place product on an even surface prior to using.

Suitable for Domestic Garden use only.

Children should not be left alone with product.

Please refrain from climbing onto the product.

Frequently check any damage to the product including the underside and tighten fixings where is required.

Cleaning Guidance

Daily cleaning:
Wipe clean with a damp cloth.
Use only clean water.
Wipe dry with a clean soft cloth.
Do not use detergents, solvents or other chemicals on oiled surfaces, as this may cause discoloration.
Color stains from eg. red wine or the like must be wiped off immediately.

For cushion covers, use sponge clean only.

We recommend the use of furniture covers when not in use.

In order to prolong the life of your product, we recommend it be stored in a dry and protected area during of season periods.

Do not use any abrasive substance which may scratch the surface.

Care and maintenance

From time to time check that there are no loose screws on this unit.

This product should not be discarded with household waste. Take to your local authority waste disposal centre.

Do not stand on seating. Do not sit on arm or backrest ledges. Give your hardwood furniture a yearly scrub with soapy water, followed by a thorough rinse. This removes algae and pollution to restore the timber's surface, keeping it in good condition.

Main Components

Please check you have all the parts listed below

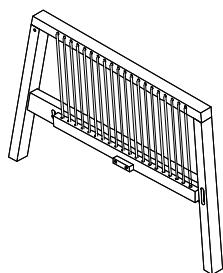

4 Leg Frame (Left) Qty 1 (585 x83mm) (880x83mm)

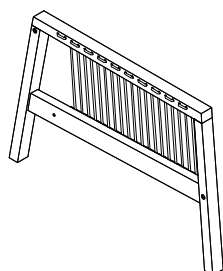

5 Leg Frame (Right) Qty 1 (585x83mm) (880x83mm)

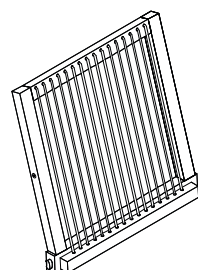

6 Backrest Frame Qty 1 (625x75mm) (608x75mm)

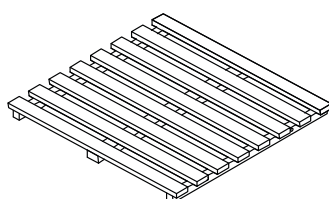

7 Seat Frame Qty 1(557x37 mm)(606x37 mm)

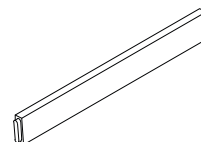

8 Front Crossbar Qty 1 (70x37 mm) (610x37mm)

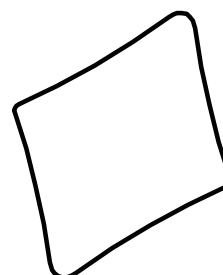

9 Back Cushion Qty 1 (510 x 590 x 150mm)

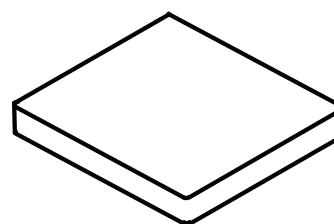



10 Seat Cushion Qty 1 (650 x 590 x 100mm)

For missing or damaged parts, call our **Customer Helpline: 01799 513466** or email cs@kobledesigns.com

Fixings, Fittings And Tools

Please check you have all the fittings listed below

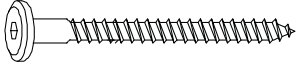
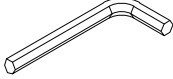
Note: The quantities below are the correct amount to complete the assembly. In some cases more fittings may be supplied than are required.

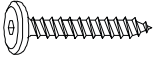
<p>A</p>  <p>80mm M7 Screw Qty 2</p>	<p>B</p>  <p>M4 Allen Key Qty 1</p>	<p>C</p>  <p>70mm M7 Screw Qty 4</p>
<p>D</p>  <p>40mm M6 Screw Qty 4</p>		

For missing or damaged parts, call our **Customer Helpline: 01799 513466** or email cs@kobledesigns.com

Assembly Steps

Step 1

Two people required

Assemble front crossbar **8** and backrest **6** in between leg frames **4** and **5** using fixings **A**, **C**.

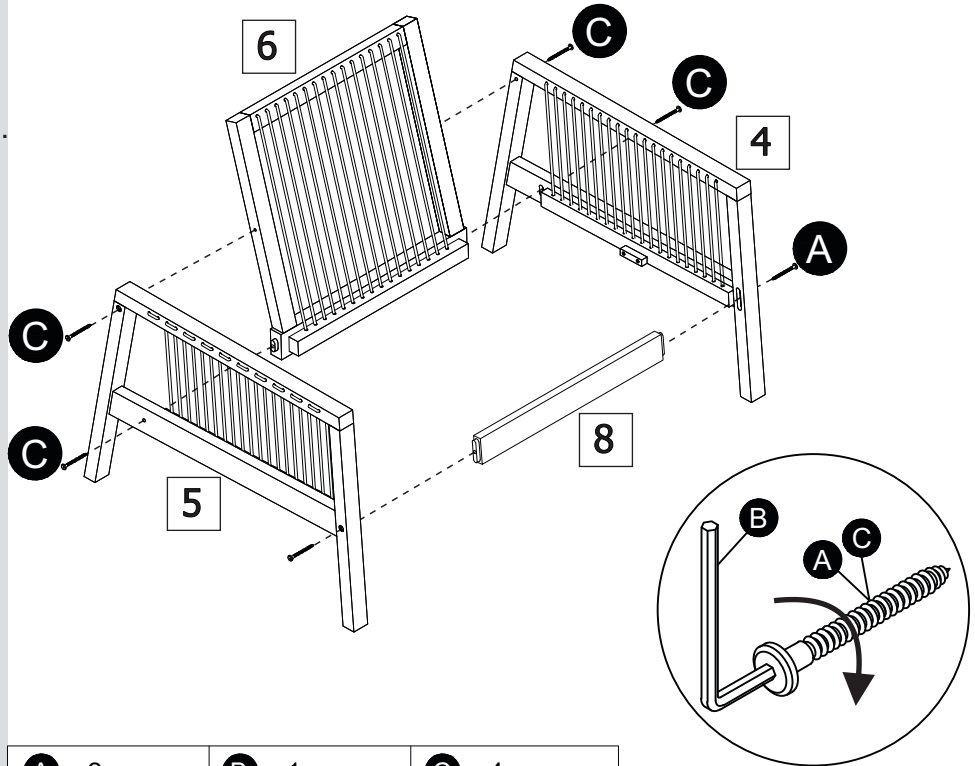

A x 2

B x 1

C x 4

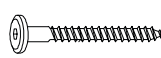

Step 2

Locate seat frame **7** into position as shown. Secure from the underside, using fixings **D**.

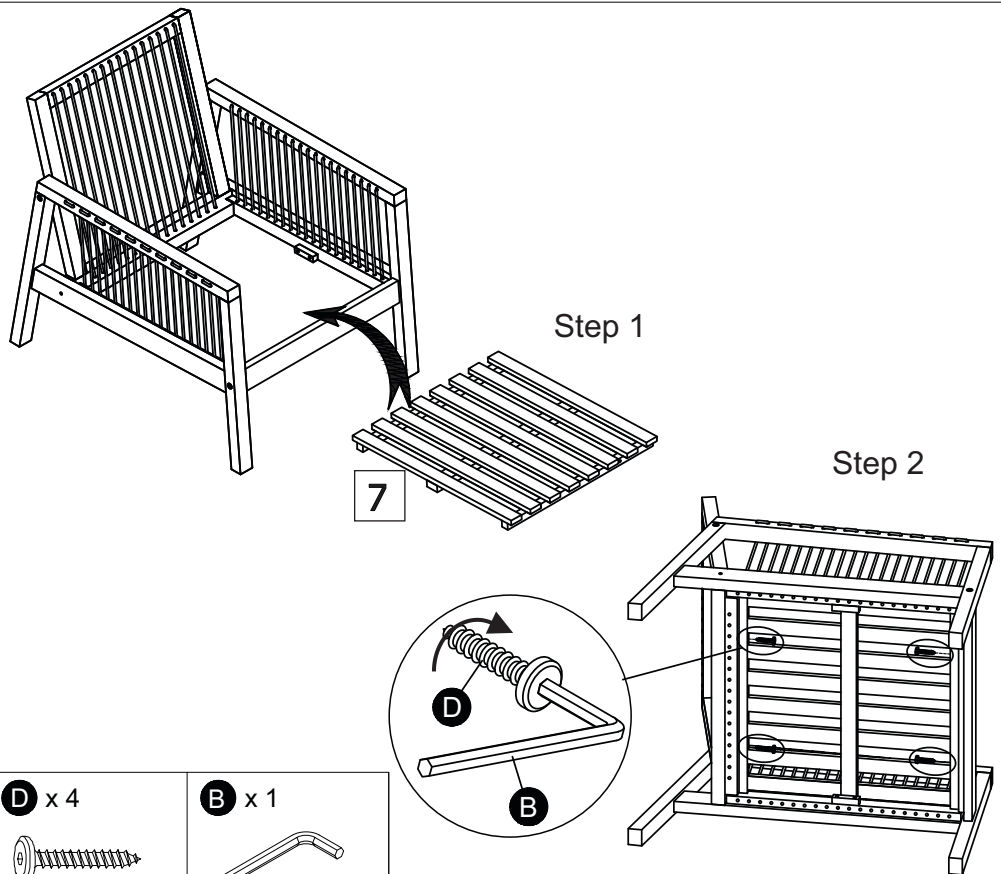

D x 4

B x 1



Assembly Steps

Step 3

Place the seat cushion **10** and back cushion **9** onto the sofa

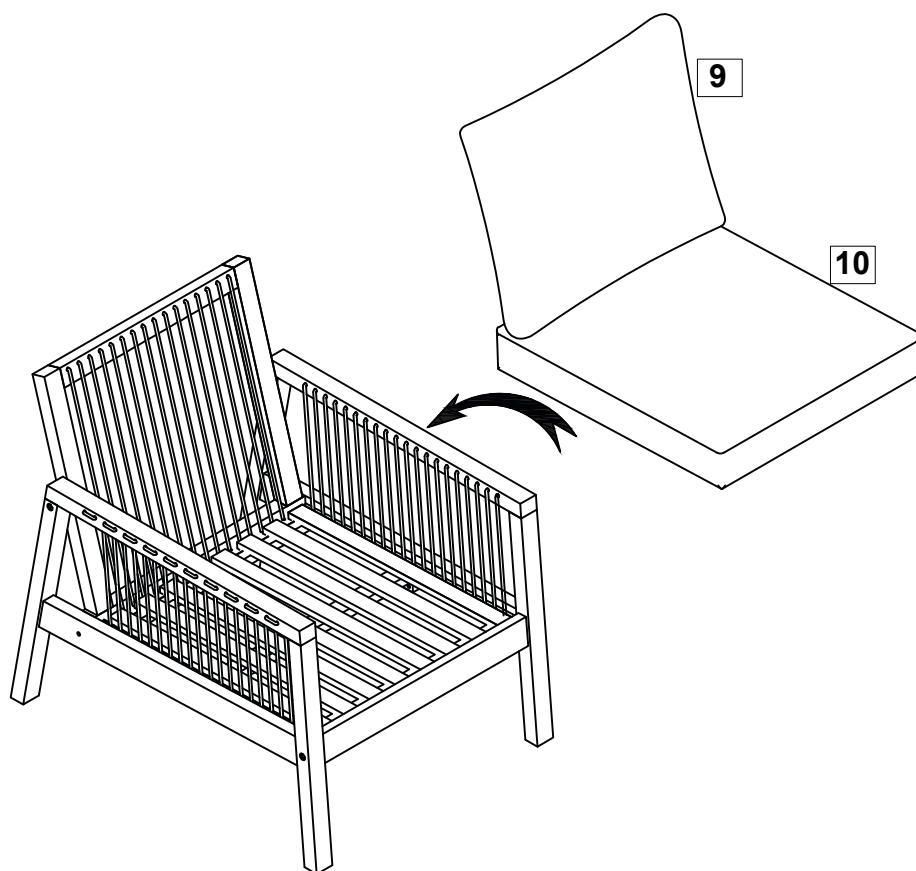

Step 4

Assembly is complete.

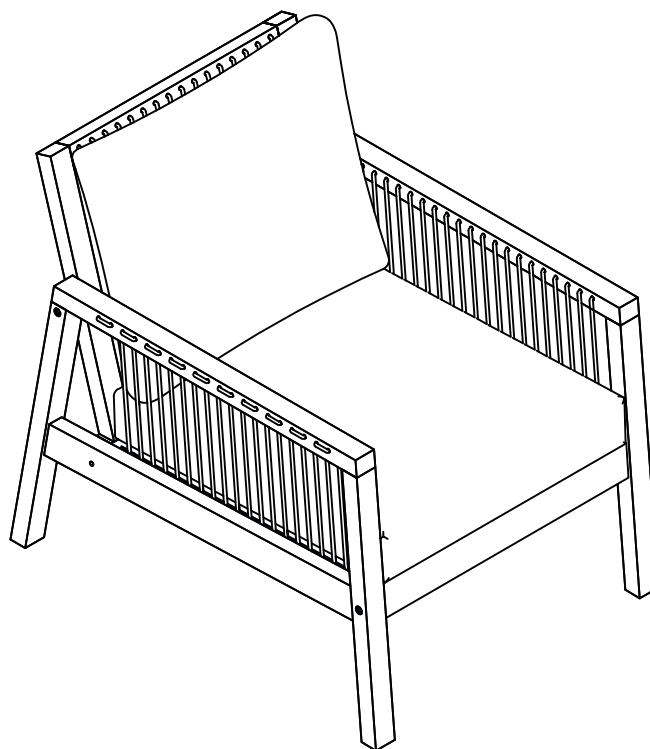

IMPORTANT, RETAIN FOR FUTURE REFERENCE: READ CAREFULLY

WARNINGS

- Dispose of all packing carefully and responsibly.
- Place product on an even surface prior to using.
- Suitable for Domestic Garden use only.
- Children should not be left alone in situ with product, please refrain children climbing onto the product.
- Frequently check any damage to the product including the underside and tighten fixings where required.

Self Assembly

- Check you have all the components and tools listed before assembly.
- Remove all fittings from the plastic bags and separate them into their groups.
- Keep children and animals away from the work area, small parts could choke if swallowed.
- Make sure you have enough space to layout the parts before starting.
- Do not stand or put weight on the parts during assembly, this could cause damage.
- Assemble on a soft level surface to avoid damaging the unit or your floor.

Tables

- Do not sit or stand on the table.

Chairs

- Do not stand on the seating.

Sun loungers

- Only one person to use lounger at any given time.
- Ensure there are no persons sitting on lounger whilst adjusting back height.

Sofas

- Do not sit on arm or back rest ledges.

CARE/CLEANING

- We recommend the use of furniture covers when not in use.
- In order to prolong the life of your product, we recommend it be stored in a dry and protected area during off season periods.
- Do not use any abrasive substances which may scratch the surface.

Glass

- Wash glass with mild soap and water, rinse thoroughly, and dry glass completely.
- Do not use any abrasive substances which may scratch the surface.

Timber

- Give your hardwood furniture a yearly scrub with soapy water, followed by a thorough rinse. This removes algae and pollution to restore the timber's surface, keeping it in good condition.

Metal/Rattan

- Use a clean soapy damp cloth and wipe down the surfaces – leave to fully dry before storing.
- Do not use any abrasive substances which may scratch the surface.

Cushions

- Sponge clean cushions only, For stubborn stains commercial available fabric cleaners are available please review application instructions on product before using on your cushions.

After Sales Support / Product Returns

Purchased from Kobledesigns.com

In the unlikely event that you need to return the item because it is faulty, please follow the 'Product Returns' instructions at www.kobledesigns.com website.

Should you need to request replacement parts, please contact our after sales support team at:-

Email - CS@kobledesigns.com

Tel:+ 44 (0)1799 513 466

Address: Koble Designs, 6 The Shires, Shirehill industrial Estate, Saffron Walden, Essex, CB11 3AP

Purchased from other retailer

If you purchased your product from one of our retailer partners, please refer back to the retailer directly, for any customer services related issued , refunds or returns requests.

Koble designs may still be able to offer supports with technical related to queries.

Disposal



This marking indicates that this product should not be disposed with other household wastes. To prevent possible harm to the environment or human health from uncontrolled waste disposal, recycle it responsibly to promote the sustainable reuse of material resources. To return your used device, please use the return and collection systems or contact the retailer where the product was purchased. They can take this product for environmental safe recycling.