

1: MARK POSITION OF POSTS

**GATE WIDTH
+ 30MM - 60MM**

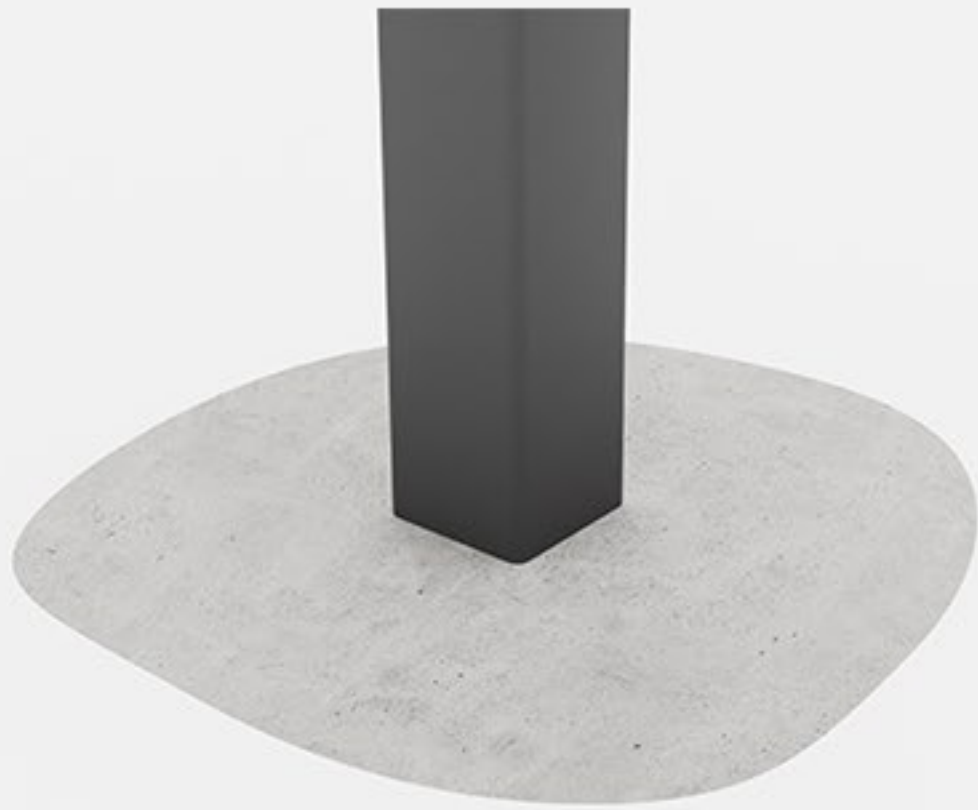

2: FLOOR OR CONCRETE MOUNT



**CONCRETE -
GO TO STEP 5**

OR

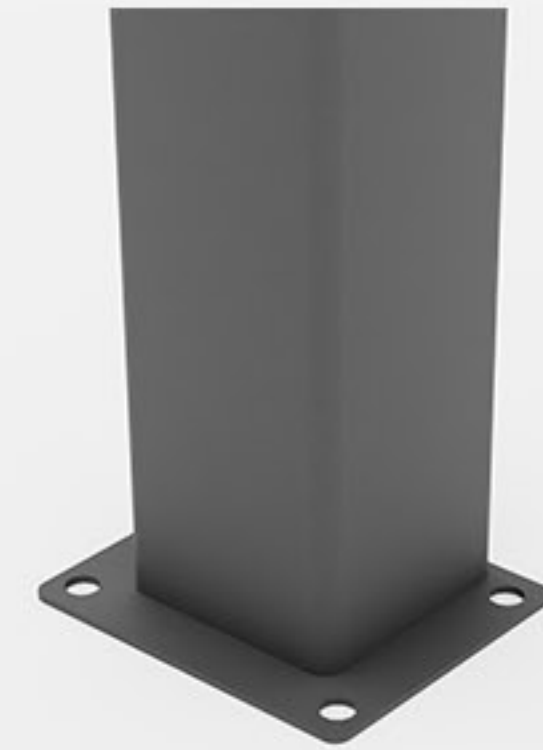

**FLOOR MOUNT -
GO TO STEP 3**

3: DRILL FLOOR BOLTS

10MM DRILL - 8 PLACES

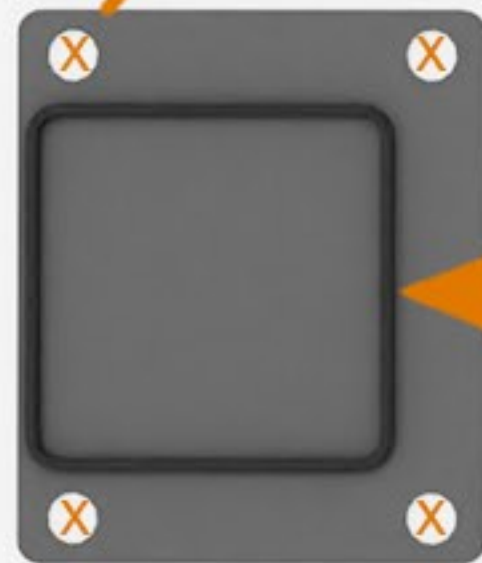

GATE WIDTH
+ 30MM

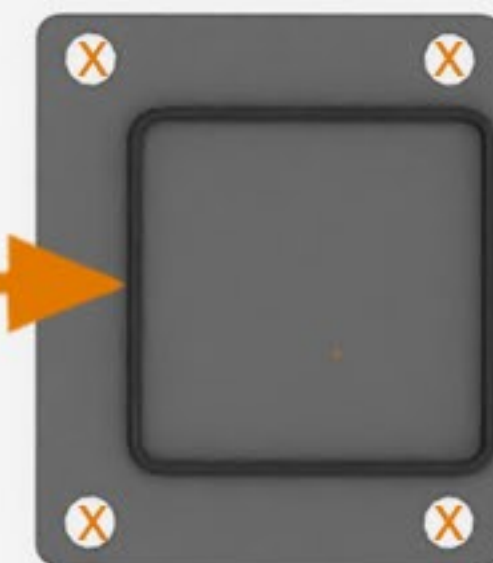

4: FIX TO FLOOR

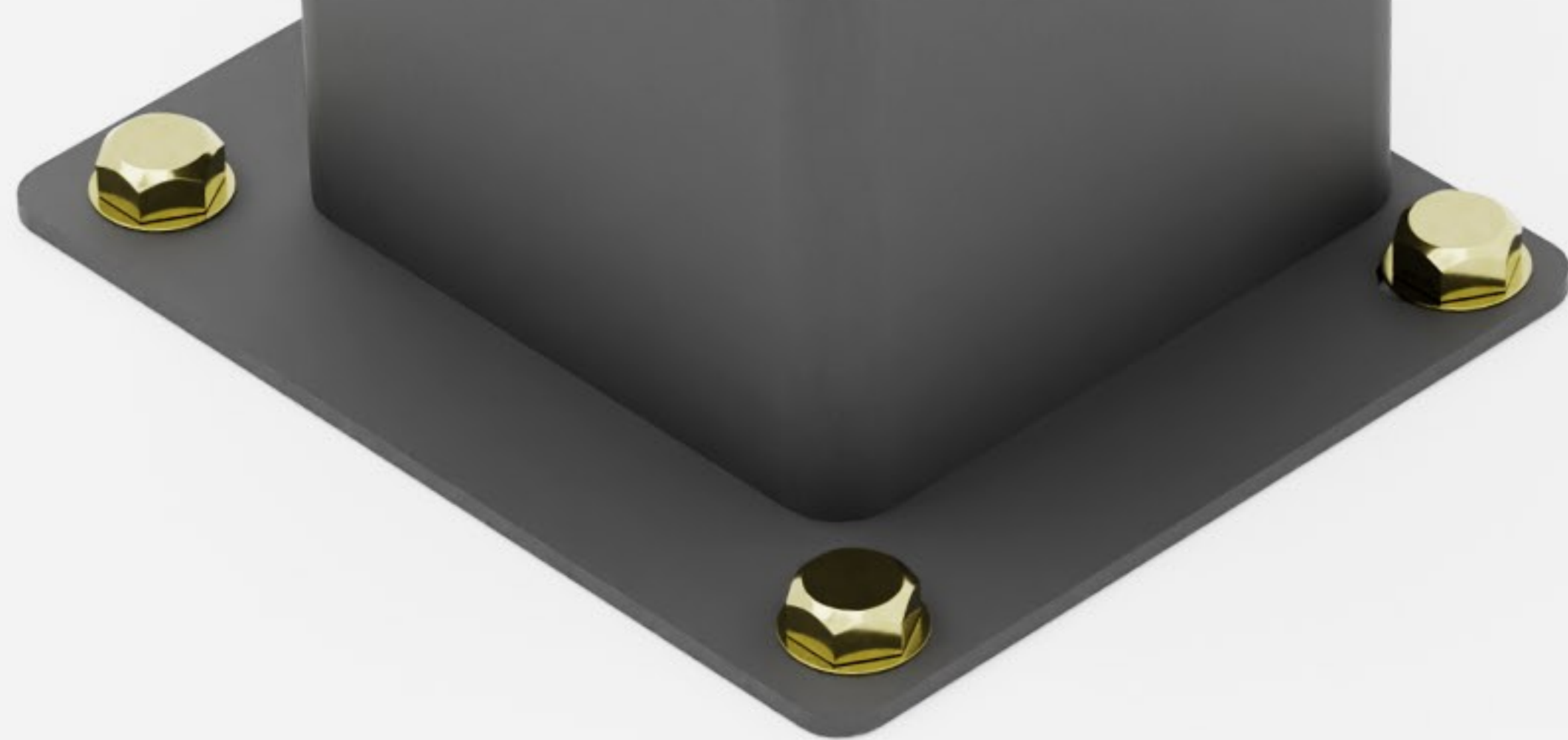

GO TO STEP 8

NOTES

- M10 X 75MM BOLTS
- 8 X PLACES
- WRENCH OR SOCKET SET



***FOR CONCRETE MOUNT ONLY**

5: DIG POST HOLES

**DIG 2 x POST HOLES
MINIMUM 500MM
BELOW GROUND LEVEL**



6: CUT 2 X POSTS TO LENGTH

**GATE HEIGHT
+ 100MM FROM
GROUND LEVEL**



7: CONCRETE POSTS

← SET WIDTH BETWEEN POSTS
GATE WIDTH + 30MM →

USE QUICKSET CONCRETE

ENSURE POSTS ARE
SQUARE IN BOTH AXIS



NOTES

- BRACKET TO POST
40MM MIN
60MM MAX
- DRILL 2 x PLACES
- 10MM DRILL





9: PRE-ASSEMBLE LOWER SPIGGOT

**M10 BOLTS
2 x PLACES**

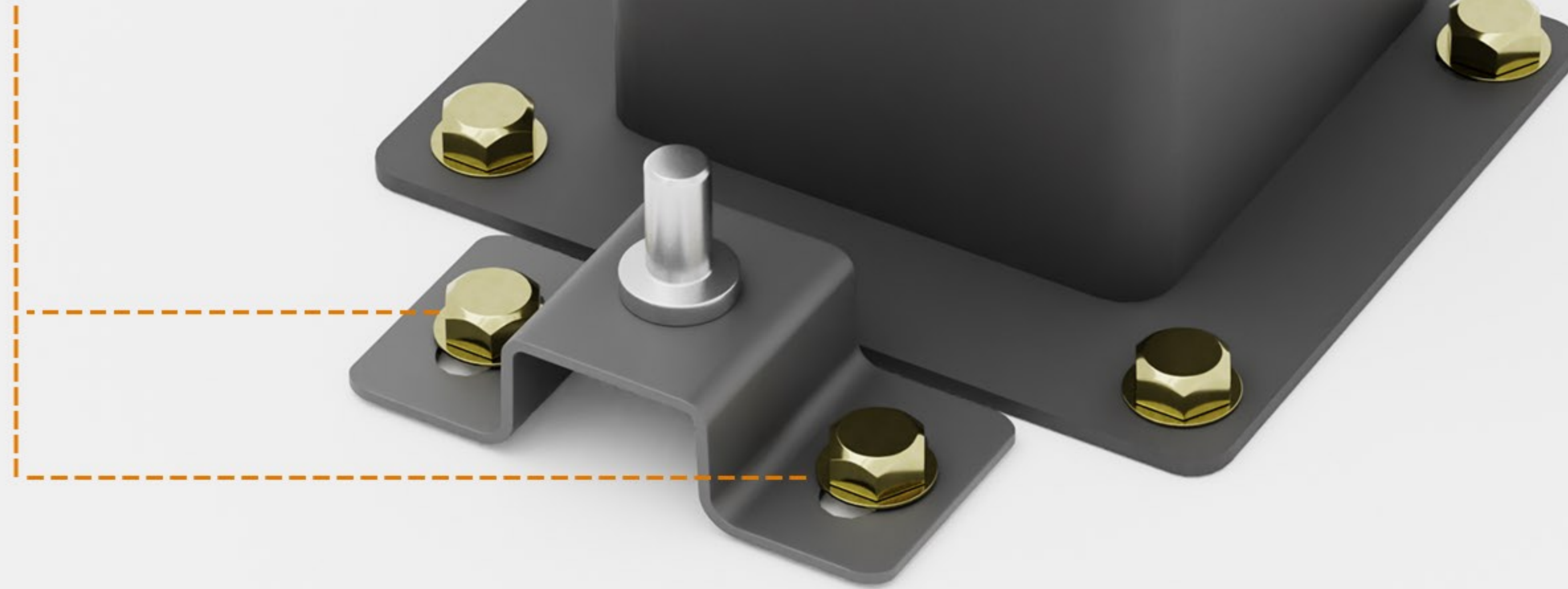

10: FIX LOWER HINGE TO FLOOR

11: ASSEMBLE UPPER SPIGGOT

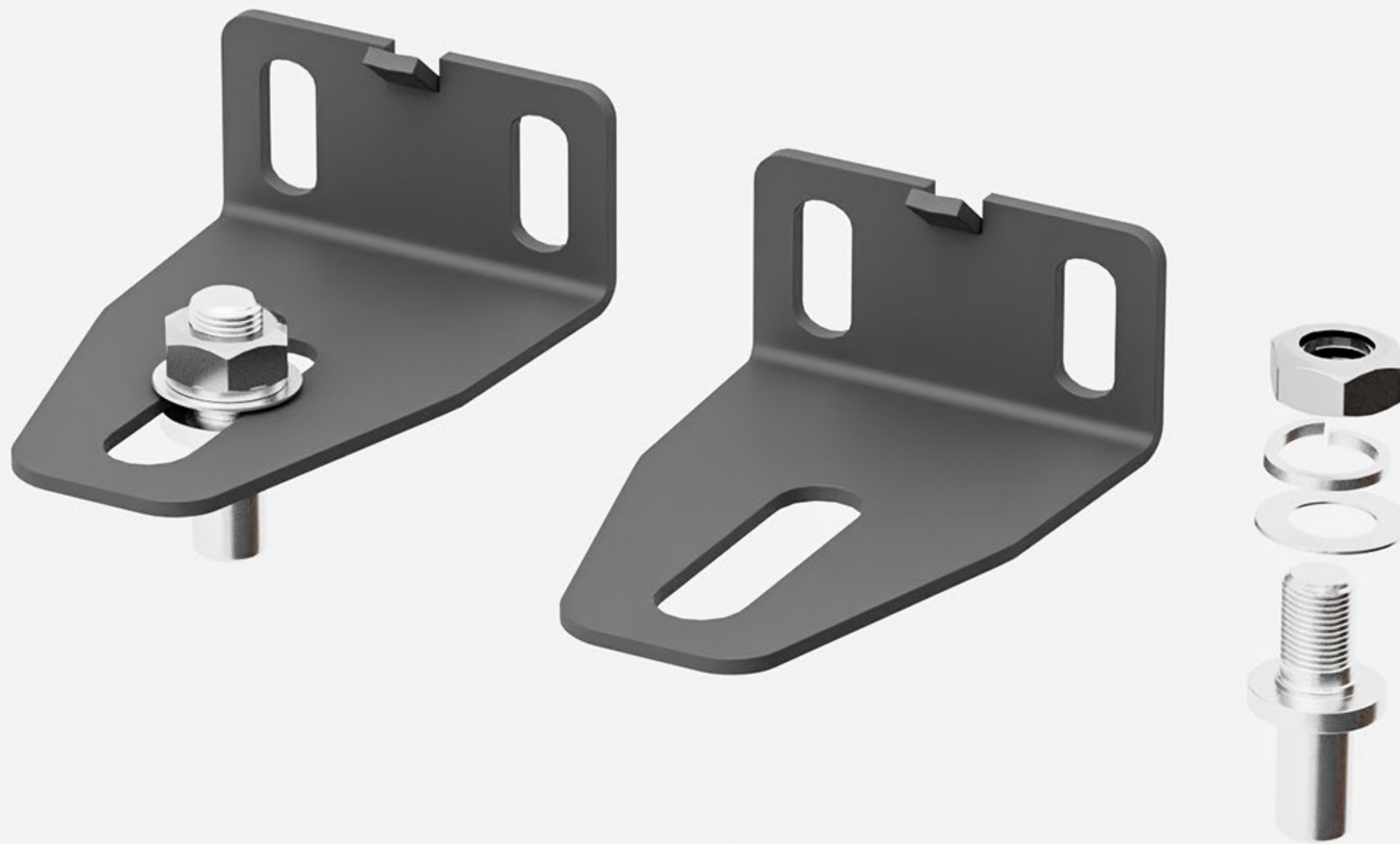

NOTES

- OPPOSITE TO LOWER BRACKET

12: LOAD GATE - HOLD SQUARE



NOTES

- HOLD GATE SQUARE
- LOAD UPPER HINGE
- MARK 2 X PLACES



13: MARK UPPER HINGE POSITION

NOTES

- DRILL 2 x PLACES
- 12MM DRILL



13: DRILL POST

NOTES

- 2 x M12 x 35MM
- 2 x M12 NUTS
- 4 x WASHERS



14: FIX UPPER HINGE

REPEAT
STEP 8 TO 15
FOR LH GATE



10MM GAP

17: ADJUST UPPER HINGES



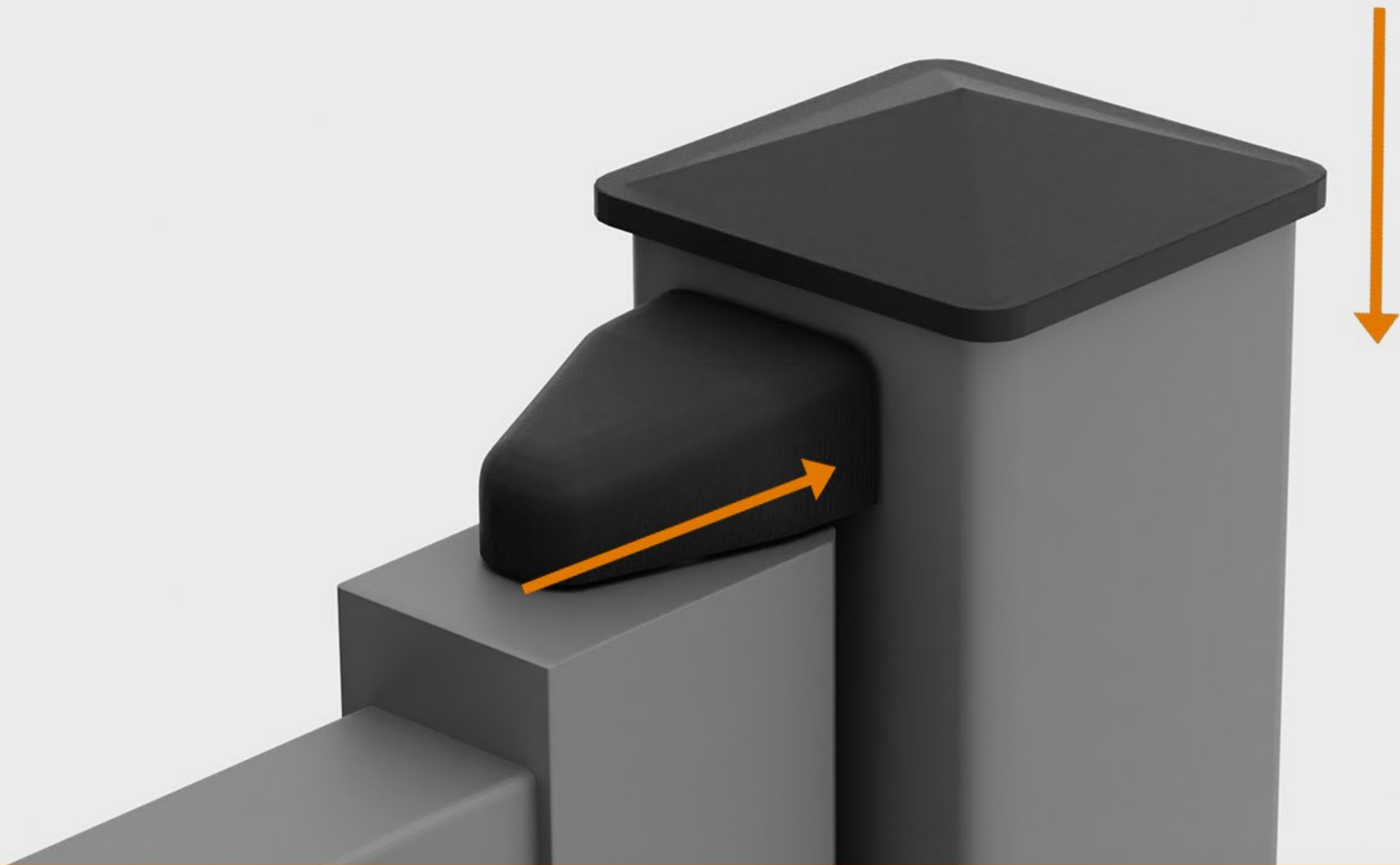

18 : FIT COVERS - 4 X PLACES

PROJECT COMPLETE

