

*N 90, INDUCTION HOB, 90 CM, BLACK,
T69FUV4L0*

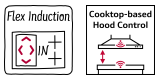
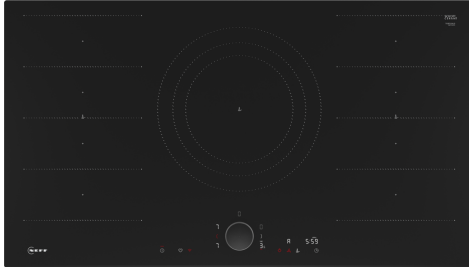

Optional accessories

Z9401FF0 Flex Pan, large, Z9401TY0 Teppan Yaki, Z9403FF0 Flex Pan set, 3 pcs., Z9404FF0 Flex Pan set, 4 pcs., Z9404SE0 4 pieces Set, Z9406SE0 6 pieces Set, Z9410ES0 Espresso maker 4 cups, Z9410X1 Stainless Steel roaster with glas lid, Z9415X1 Steaming Rack for Stainless Steel roaste, Z9416X2 Griddle Plate, Z9417X2 Teppan Yaki (large), Z9428FE0 Iron pan Ø 18 / 28 cm, Z943SE0 Set of 2 pots and 1 pan, Z9451X0 System pan diameter 15 cm, Z9453X0 System pan diameter 21cm, Z9454X0 Paella pan Ø 31 cm, Z9801TWAY0 Twist Pad Flex, Anthracite Grey

Standalone Flex Induction hob with Twist Pad® control.

- ✓ Flex Induction – Your hob detects and heats your individual cookware.
- ✓ Hob-based Hood Control – convenient operation of the hood via your hob.
- ✓ Power Boost – An extra surge of heat when you need fast results.
- ✓ Induction – the heat is generated directly in the cookware for precise cooking that stops when power is off.

Features

Technical Data

Product name/family: Cooking zone ceramic
 Construction type: Built-in
 Energy input: Electric
 Number of cooking zones: 5
 Min. required niche size for installation (HxWxD): .. 51 x 880-880 x 490-500 mm
 Width of the appliance: 918 mm
 Dimensions: 51 x 918 x 522 mm
 Dimensions of the packed product (HxWxD): 126 x 1073 x 608 mm
 Net weight: 18.4 kg
 Gross weight: 22.1 kg
 Residual heat indicator: Separate
 Location of control panel: Hob front
 Basic surface material: Ceramic
 Color of surface: Black
 EAN code: 4242004269137
 Voltage: 220-240 V
 Frequency: 50-60 Hz



N 90, INDUCTION HOB, 90 CM, BLACK, T69FUV4L0

Features

- 90 cm: space for 5 pots or pans.

Flexibility of cooking zones

- 2 Flex zones: use cookware of any shape or size anywhere within the 40cm long zone.
- Ring zone triple: use regular up to extra large cookware (e.g. paella pans) on the expandable cooking zone.
- Cooking zone front left: 200 mm, 230 mm, 2.2 KW (max. power 3.7 KW)
- Cooking zone rear left: 200 mm, 230 mm, 2.2 KW (max. power 3.7 KW)
- Cooking zone middle: 210 mm, 260 mm, 320 mm, 2.2 KW (max. power 3.7 KW)
- Cooking zone rear right: 200 mm, 230 mm, 2.2 KW (max power 3.7 KW)
- Cooking zone front right: 200 mm, 230 mm, 2.2 KW (max. power 3.7 KW)

Usage convenience

- Two coloured display (white/red): easily see which function is activated.
- yes: directly access favourite functions with a configurable button (available with connected Home Connect account).
- Variable 17-stage power settings for each zone: precisely adapt the heat with 17 power levels (9 main levels and 8 intermediate levels).
- Switch-off timer: switches off the cooking zone at the end of the time set (e.g. for boiled eggs).
- alternative: an alarm sounds at the end of the time set (e.g. for pasta).
- Sound volume adaptable to personal preference and needs.

Time saving & efficiency

- Power Boost function for all zones
- : boil water faster thanks to 50% more energy than at the highest standard level.
- Cooking zones will be automatically joined or separated based on the shape and size of the cookware placed.
- PowerTransfer: when moving a pot to a different cooking zone, this feature transfers all previous settings to the new zone at the touch of a button.
- yes: when switched on, the hob automatically selects the cooking zone on which a new cookware is placed. yes: when switched on, the hob automatically selects the cooking zone on which a new cookware is placed.
- when moving a pot, the settings adjust instantly and the cooking zone adapts to the size of the cookware
- QuickStart function: when switching on, the hob automatically selects the cooking zone with cookware (when placed on a zone whilst the hob is off).
- ReStart function: in case of unintentional switch-off, this feature restores all previous settings by switching on the hob again within 4 seconds.

Cooking assistance

- 11 frying levels: prevents overcooking with the automatic temperature regulation of the integrated sensor.
- Dish assistant: easily find the right temperature setting for a certain

dish via the home connect app.

Connectivity

- Home Connect with Remote Monitoring: check if the hob is switched off even when not at home, and find recipes or additional functions in the Home Connect app.
- Hob Hood Control - hood control (with Wi-Fi enabled hood): automatically activates the hood when cooking, thanks to the WiFi connection of hob and suitable hood.
- yes, after software update: hood automatically adapts fan speed thanks to hob continuously providing cooking data (with matching hood and connected Home Connect account).
- via MyButton: open up the smart universe from your cooktop (partner service required). via MyButton: open up the smart universe from your cooktop (partner service required).
- Updateable appliance (available with connected Home Connect account): keep appliance always up to date with latest status of software. Updateable appliance (available with connected Home Connect account): keep appliance always up to date with latest status of software.

Design

- Bevelled front edge

Safety

- 2 stage residual heat indicators: indicates which cooking zones are still hot or warm.
- Control panel lock: prevent unintended activation of the hob.
- pause function: pause the heating process, e.g to answer the door.
- Main switch: switch off all cooking zones at the touch of a button.
- Safety cut out facility: for safety reasons, heating stops after a preset time if not used (possible to customise).

Installation

- Dimensions of the product (HxWxD mm): 51 x 918 x 522
- Required niche size for installation (HxWxD mm) : 51 x 880 x (490 - 500)
- Min. worktop thickness: 16 mm
- Connected load: 11.1 KW
- 4.6kW power output (20A); current management options for 16A, 13A or 10A connection: limit the maximum power if needed (depends on fuse protection of electric installation).

Accessories

- Twist Pad included

N 90, INDUCTION HOB, 90 CM, BLACK,
T69FUV4L0

Dimensioned drawings

Measurements in mm

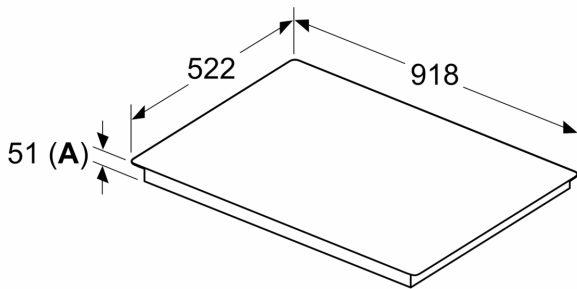

A: Recessed depth

Measurements in mm

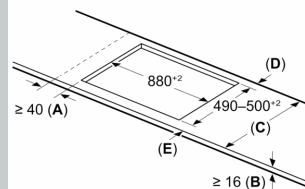

A: Min. distance from the hob cut-out to the wall

B: The clearance between the surface of the worktop and the top of the front of the oven must be 30 mm

See space requirements for the oven

The worktop into which the hob is installed must withstand loads of approx. 60 kg; suitable substructures must be used if required

C	D	E
585-600	50	≥ 35
> 600	≥ 50	≥ 50

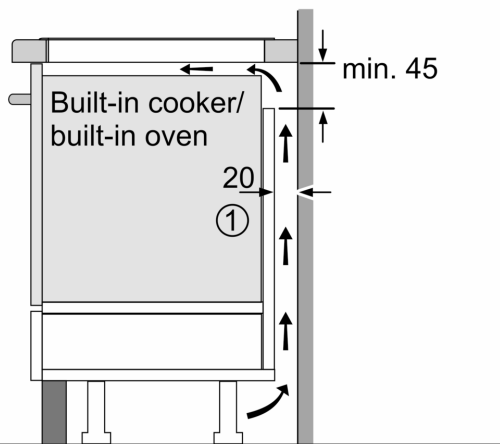

① Ventilation gap must be present

All measurements in mm

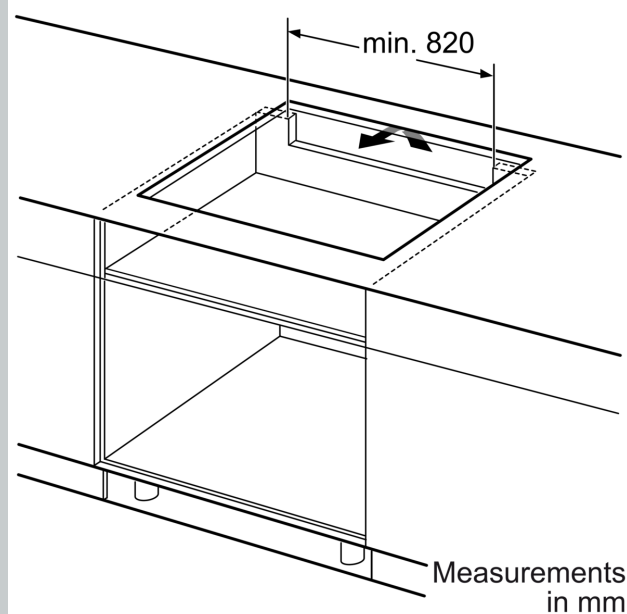

Measurements in mm

Dimensioned drawings

