

AED560

125mm x 6m ducting kit

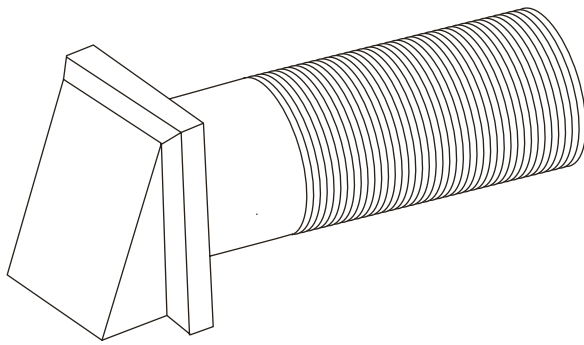

Contents

1. External wall vent x 1
2. 125mm x 6m hose
3. Cable Tie x 2
4. Fixing Screws with wall plugs x 4
5. Hose fixing studs x 3

Fitting Instructions

1. Using a core drill cut apertures through wall
2. Thread flexible hose through hole in wall and fix to outside wall vent using the 3 studs supplied
3. Position outside wall vent, mark 4 fixing positions, drill fixing holes, then fit vent using the 4 screws and wall plugs supplied
4. Ensuring flexible hose is as straight as possible, trim to length, fit over cooker hood spigot and fix with cable tie provided (**Note:** Do not kink hose as this could restrict airflow)

IMPORTANT:

Ensure that you check your cooker hood grease filter on a regular basis as grease vapours can become trapped and this could affect the efficiency of your extractor.

WARNING:

It is important that where an air extraction unit is fitted in a room with an open flame appliance, an air back flow should be provided to avoid the reversal of flue gasses.