



EN User Manual | **Cooker Hood**

GDE682HM

GDE686HM

GDE689HM



Welcome to AEG! Thank you for choosing our appliance.



Get usage advice, brochures, trouble shooter, service and repair information:
www.aeg.com/support

Subject to change without notice.

CONTENTS

1. SAFETY INFORMATION.....	2
2. SAFETY INSTRUCTIONS.....	5
3. INSTALLATION.....	6
4. PRODUCT DESCRIPTION.....	6
5. DAILY USE.....	7
6. CARE AND CLEANING.....	8
7. TROUBLESHOOTING.....	10
8. ENVIRONMENTAL CONCERNS.....	10

1. ⚠ SAFETY INFORMATION

Before the installation and use of the appliance, carefully read the supplied instructions. The manufacturer is not responsible for any injuries or damage that are the result of incorrect installation or usage. Always keep the instructions in a safe and accessible location for future reference.

1.1 Children and vulnerable people safety

- This appliance can be used by children aged from 8 years and above and persons with reduced physical, sensory or mental capabilities or lack of experience and knowledge if they have been given supervision or instruction concerning the use of the appliance in a safe way and understand the hazards involved. Children of less than 8 years of age and persons with very extensive and complex disabilities shall be kept away from the appliance unless continuously supervised.
- Children should be supervised to ensure that they do not play with the appliance.
- Keep all packaging away from children and dispose of it appropriately.

- Keep children and pets away from the appliance when it operates.
- Children shall not carry out cleaning and user maintenance of the appliance without supervision.

1.2 General Safety

- This appliance is intended for domestic use above hobs, cookers and similar cooking devices.
- This appliance is designed for single household domestic use in an indoor environment.
- This appliance may be used in, offices, hotel guest rooms, bed & breakfast guest rooms, farm guest houses and other similar accommodation where such use does not exceed (average) domestic usage levels.
- Before carrying out any maintenance, disconnect the appliance from the power supply.
- **CAUTION:** Accessible parts may become hot during use with cooking appliances.
- Use only the fixing screws supplied with the appliance if not supplied, use the screws recommended in the installation instructions. Install the appliance in a safe and suitable place that meets installation requirements.
- **WARNING:** Failure to install the screws or fixing device in accordance with these instructions may result in electrical hazards.
- Do not use adhesives to fix the appliance.
- The minimum distance between the hob surface on which the pans stand and the lower part of the appliance shall be at least 65 cm, unless otherwise specified in the installation instructions for the appliance or hob.
- The discharge of air must comply with local authorities regulations.
- Ensure good air ventilation in the room where the appliance is installed to avoid the backflow of gases into the room from appliances burning gas or other fuels, including open fires.

- Make sure that the ventilation openings are not blocked and the air collected by the appliance is not conveyed into a duct used to exhaust smoke and steam from other appliances (central heating systems, thermosiphons, water-heaters, etc.).
- When the appliance operates with other appliances the maximum vacuum generated in the room should not exceed 0.04 mbar.
- If the supply cord is damaged, it must be replaced by the manufacturer, its Authorised Service Centre or similarly qualified persons to avoid an electrical hazard.
- If the cord set is damaged, it must be replaced by a special cord set available from the manufacturer or its Authorised Service Centre.
- If the appliance is connected directly to the power supply, the electrical installation must be equipped with an isolating device that allows to disconnect the appliance from the mains at all poles. Complete disconnection must comply with conditions specified in the overvoltage category III. The means for disconnection must be incorporated in the fixed wiring in accordance with the wiring rules.
- Do not flambé under the appliance.
- Do not use to exhaust hazardous or explosive materials and vapours.
- Clean the appliance regularly with a soft cloth to prevent the deterioration of the surface material.
- Do not use a steam cleaner, water spray, harsh abrasive cleaners or sharp metal scrapers to clean the surface of the appliance. Use only neutral detergents.
- Clean grease filters regularly (at least every 2 months) and remove grease deposits from the appliance to prevent the risk of fire.
- Use a cloth to clean the interior of the appliance.

2. SAFETY INSTRUCTIONS

2.1 Installation

WARNING!

Risk of injury, electric shock, fire, burns or damage to the appliance.

- Only a qualified person must install this appliance.
- Do not install or use a damaged appliance.
- Follow the installation instructions supplied with the appliance.
- Always take care when moving the appliance as it is heavy. Always use safety gloves and enclosed footwear.
- Before installing the appliance remove all the packaging, the labelling and the protective film.
- Do not install the exhaust air into a wall cavity, unless the cavity is designed for that purpose.

2.2 Electrical connection

WARNING!

Risk of fire and electric shock.

- All electrical connections should be made by a qualified electrician.
- Make sure that the parameters on the rating plate are compatible with the electrical ratings of the mains power supply.
- If the symbol () is not printed on the rating plate, the appliance must be earthed.
- Always use a correctly installed shockproof socket.
- Do not let the electricity mains cable tangle.
- Do not use multi-plug adapters and extension cables.
- If the mains socket is loose, do not connect the mains plug.
- Do not pull the mains cable to disconnect the appliance. Always pull the mains plug.
- The shock protection of live and insulated parts must be fastened in such a way that it cannot be removed without tools.

- Make sure the appliance is installed correctly. Loose and incorrect electricity mains cable can make the terminal become too hot.
- Connect the appliance at the end of the installation. Make sure that there is access to the mains after the installation.

2.3 Use

WARNING!

Risk of injury, burns and electric shock.

- This appliance is for cooking purpose only. Do not use the appliance for other purpose.
- Do not change the specification of this appliance.
- Do not operate the appliance with wet hands or when it has contact with water.
- Use only the accessories supplied with the appliance.
- Keep flames or heated objects away from fats and oils during cooking and frying.
- Do not use uncovered electric grills.
- Do not use the appliance as a storage surface.
- Do not use magnifying glasses, binoculars or similar optical devices to look directly at the lighting of the appliance.
- If the appliance works with other devices, the maximum developed pressure must not exceed 4 Pa (4x10⁻⁵ bar).

2.4 Service

- To repair the appliance contact the Authorised Service Centre. Use original spare parts only.
- Concerning the lamp(s) inside this product and spare part lamps sold separately: These lamps are intended to withstand extreme physical conditions in household appliances, such as temperature, vibration, humidity, or are intended to signal information about the operational status of the appliance. They are not intended to be used in other applications and are not suitable for household room illumination.

2.5 Disposal

⚠ WARNING!

Risk of injury or suffocation.

- Contact your municipal authority for information on how to dispose of the appliance.

- Disconnect the appliance from the mains supply.
- Cut off the mains electrical cable close to the appliance and dispose of it.

3. INSTALLATION

⚠ WARNING!

Refer to Safety chapters.

3.1 Installation instructions



For complete information about the installation of the appliance refer to a separate installation booklet.

⚠ WARNING!

Before connection to electricity make sure the blower support has been removed from the motor.

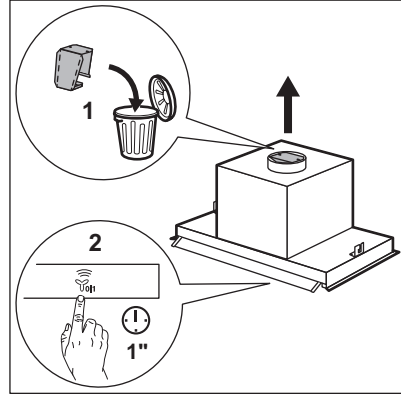

4. PRODUCT DESCRIPTION

4.1 Control panel overview

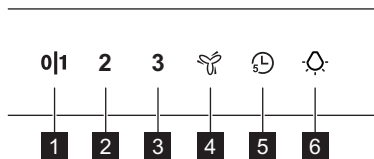

Function	Description
1 First speed / Off	The motor switches to first speed level. Second press turns off the appliance.
2 Second speed	The motor switches to second speed level.
3 Third speed	The motor switches to third speed level.

Function	Description
4 Maximum speed	The motor switches to maximum speed level. After 5 minutes appliance switches to third speed.
5 Timer	Turns off the appliance after 5 minutes. Reminds to clean or replace the filter. Refer to Filter notification in Daily use chapter.
6 Lamp	Turns the lights on and off.

5. DAILY USE

5.1 Using the hood

Check the recommended speed according to the table below.

0 1	While heating up food, cooking with covered pots.
2	While cooking with covered pots on multiple cooking zones or burners, gentle frying.
3	While boiling and frying big quantities of food without a lid, cooking on multiple cooking zones or burners.
	While boiling and frying big quantities of food without a lid, big humidity.



It is recommended to leave the hood operating for approximately 15 minutes before and after cooking.

Activating the appliance



The control Panel is a sensor field. To operate the hood touch the symbol exactly in the middle for at least 1 second.

To operate the hood:

1. Open the glass with control panel symbols.

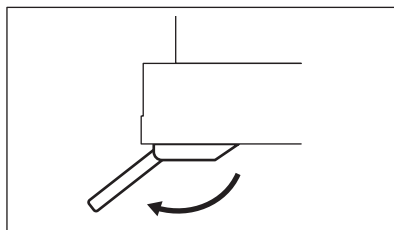

2. Touch the 0|1 to switch on the appliance.
3. If needed, change the speed by touching the desired symbol.

Deactivating the appliance

To turn off the appliance touch 0|1 again.



Lighting

Activating and deactivating the lighting

To illuminate the cooking surface touch the  symbol.

5.2 Timer

This function allows to turn off the appliance after 5 minutes of operating. The function can be used only if the appliance operates on first 3 motor speeds.

1. Touch the  symbol. Timer starts to flash.
 2. After 5 minutes the appliance turns off.
- To turn off the function touch  again.

5.3 Hob²Hood function

It is an automatic function which connects the hob with a hood. Both the hob and the hood have an infrared signal communicator. Speed

of the fan is defined automatically on basis of mode setting and temperature of the hottest cookware on the hob. You can also operate the fan using the hob manually. The function can be activated from panel of the hob.

Led lamp switches on when the connection is established between the hob and hood.



The element underneath the hood (1) is a signal receiver of the function.

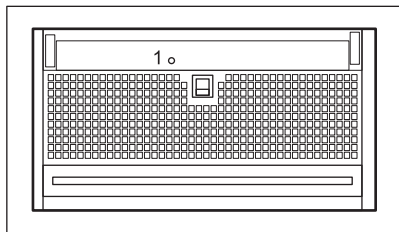

For more information how to use the function, refer to the hob user manual.

5.4 Filter notification

Filter alarm reminds to change or clean the charcoal filter and clean the grease filter.

- After 40 hours of usage, the symbol turns on for 30 seconds. The grease filter must be cleaned.
- After 160 hours of usage, the symbol flashes for 30 seconds. The grease filter must be cleaned and charcoal filter must be replaced or cleaned.



Refer to cleaning the grease filter in care and cleaning chapter.



Refer to cleaning the charcoal filter or replacing the charcoal filter in care and cleaning chapter.

To reset the function touch for 3 seconds.

6. CARE AND CLEANING

6.1 Notes on cleaning



Cleaning Agents

Do not use abrasive detergents and brushes.

Clean the surface of the appliance with a soft cloth with warm water and a mild detergent.

After cooking some parts of appliance can get hot. To avoid stains appliance must be cooled down and dried with clean cloth or paper towels.

Clean stains with a mild detergent.



Keep the hood clean

Clean the appliance and grease filters each month. Clean the interior and grease filters carefully from fat. Fat accumulation or other residue may cause fire.

Grease filters can be washed in a dishwasher.

The dishwasher must be set to a low temperature and a short cycle. The grease filter may discolour, it has no influence on the performance of the appliance.



Charcoal filter

The time of saturation of the charcoal filter varies depending on the type of cooking and the regularity of cleaning the grease filter. Charcoal filter is washable, clean or regenerate the filter after approximately every two months.





Before carrying out any maintenance, make sure there is no cookware on the hob and that the hood and the hob are disconnected from the power supply.

6.2 Cleaning mode

Cleaning mode blocks the functionality of control panel for 5 minutes. When active, touching symbols has no effect.



Hob2Hood function is disabled when cleaning mode is active.

1. To activate the mode, touch and hold **0|1** and  for 3 seconds. **0|1** and  turns on.
2. To deactivate the mode, touch and hold the symbols again for 3 seconds. **0|1** and  turns off.

6.3 Cleaning the grease filter

Filters are mounted with the use of clips and pins on the opposite side.

To clean the filter:

1. Pull the handle on the filter underneath the hood (1) and slightly tilt the front of the filter down.

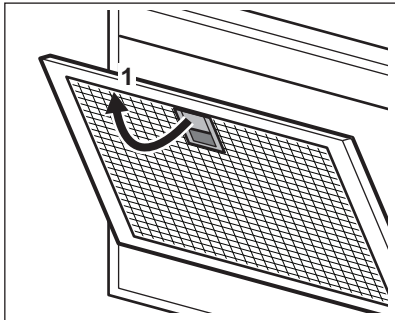

2. Clean the filters using a sponge with non abrasive detergents or in a dishwasher.



The dishwasher must be set to a low temperature and a short cycle. The grease filter may discolour, it has no influence on the performance of the appliance.

3. To mount the filters back follow the first two steps in reverse order. Repeat the steps for all filters if applicable.

6.4 Cleaning the charcoal filter

To remove the filter:

1. Remove the grease filters from the appliance.

Refer to "Cleaning the grease filter" in this chapter.

2. Press the handle of the mounting clip on the filter panel underneath the hood (1).

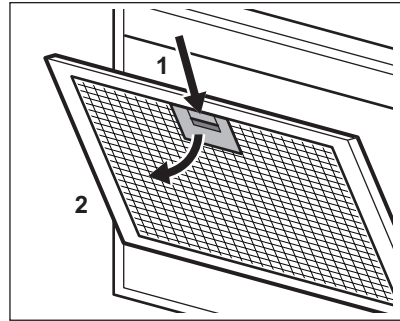

3. Slightly tilt the front of the filter downwards (2), then pull. Repeat the steps for all filters.
4. Wash the filter bed in hot water without using detergent or use a dishwasher.



Set the dishwasher without using rinse aids or any other detergents. The dishwasher cannot be filled with dishes.

5. Leave the filter bed to dry or use an oven.

WARNING!

Risk of burns! Refer to safety chapter in oven user manual.

Set the oven to a maximum temperature of 60°C.

6. To install the filter, perform the steps in reverse order.



The filter has to be fully dried before installing it back into appliance.

The maximum number of regeneration cycles is 8. For intense usage, it is not advisable to execute more than 6 cycles.

6.5 Replacing the lamp

This appliance is supplied with a LED lamp and separate control gear (LED driver). These parts can be replaced by a technician only. In case of any malfunction refer to "Service" in the "Safety Instructions" chapter.

7. TROUBLESHOOTING



WARNING!

Refer to Safety chapters.

7.1 What to do if...

Problem	Possible cause	Remedy
You cannot activate the appliance.	The appliance is not connected to a power supply or it is connected incorrectly.	Check if the appliance is correctly connected to the electrical supply.
You cannot activate the appliance.	The fuse is blown.	Make sure that the fuse is the cause of the malfunction. If the fuse is blown again and again, contact a qualified electrician.
You cannot activate the appliance.	Cabinet doors are not aligned with the cabinet frame.	Align the cabinet doors.
You cannot activate the appliance.	The glass panel is not fully opened.	Fully open the glass panel. Refer to daily use chapter.
You cannot activate the appliance or functions.	Incorrect usage of control panel.	Touch the symbols on the control panel directly in the middle for at least 1 second to activate appliance or function.
The lamp does not operate.	The lamp is defective.	Replace the lamp. Refer to the "Care and Cleaning" chapter.
The appliance does not absorb enough vapours.	The motor speed is not adequate to the appearing vapours.	Change the speed of the motor.
The appliance activate itself or change function itself	There is a big condensation of vapour on the glass.	Clean the glass from the water, ventilate the kitchen and increase the speed of the hood.
The filter alarm indicator  is on.	The filter alarm is on. The grease filter must be cleaned or the charcoal filter must be replaced or cleaned.	Refer to the filter notification in "Daily use" chapter.

8. ENVIRONMENTAL CONCERNS

Recycle materials with the symbol . Put the packaging in relevant containers to recycle it.

Help protect the environment and human health by recycling waste of electrical and

electronic appliances. Do not dispose of appliances marked with the symbol  with the household waste. Return the product to

your local recycling facility or contact your municipal office.

aeg.com

867382501-A-072024



UK
CA CE