

Balmoral









INSET ELECTRIC FIRE

BAL20CH



Balmoral Chrome

Features

-  Unique Optiflame effect
-  2kW heat output
-  Choice of 2 heat settings
-  Thermostat
-  LED lighting
-  Side switch control
-  Coal fuel bed
-  Flame effect without heat

Balmoral Chrome



Chrome



Manual Control



Spacer Kit



OSP004

Balmoral

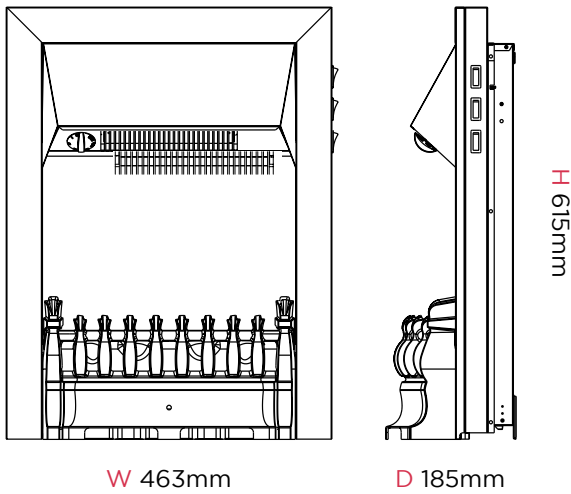

W 463mm

D 185mm

H 615mm

Dimensions & Weight

Height (mm)	Width (mm)	Depth (mm)	Weight (kg)
615	463	185	7.9

Product Features

Product Category	Electric Fires
Product Type	Inset
Brand	Dimplex
Model/Range Name	Balmoral
Flame Effect	Optiflame
Model Reference	BAL20CH
Material Code	X-047502
Barcode	5011139047502
Commodity Code	8516299100
Country of Origin	PRC
Approvals	UKCA, BEAB
Guarantee Period	1 year

Product Features

Heat Output	2kW
Heat Settings	2 - 1kW / 2kW
Variable Thermostat	Y
Fan Heat / Radiant Heat	Yes / No
Location of Controls	On side panel
On/Off Switch	Y
Remote Control	N
Batteries Included	N
Optiflame Effect	Y
Flame Type	Rotisserie
Flame Effect Only	Y
Fuel Bed Supplied	Coal

Product Features

Lot 20 Compliant	Y
Freestanding	Y (with spacer)
Wall Mountable	N
Inset	Y
Suite	N
Spacer Kit	Y - X-048264
Lamp Type	LED
Safety Cut Out	Y
Kettle (IEC) Lead	Y
Power Cord Length	1.4m
Core Materials	Steel / Plastic
Finish / Colour	Chrome