

10 YEAR
WARRANTY



Installation Instructions



Benefits of using the system.



Works with any boiler/heat pump

H₂O version can connect to any source of warm water.



Energy efficient

Even, all-around heat uses less energy yet provides real warmth



Fast and responsive

No under heating or over heating.



Simple installation

Installed with minimal disturbance or modification to your home



Works with any floor finish

Carpet, laminate, timber, vinyl with equal performance.



Free up wall space

Create a more spacious and versatile environment.



True radiant heat

Minimal air movement and no drafts create real comfort



Hygienic, Healthcare Heating

Versions available suitable for use in the NHS and Assisted Living projects.

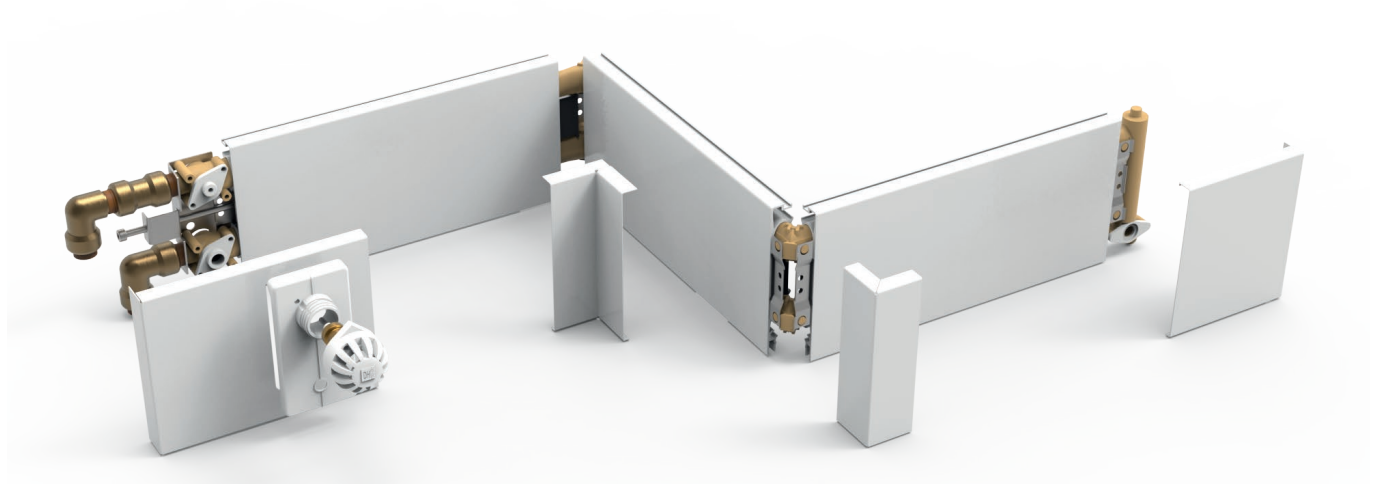

10 YEAR WARRANTY +

See T's and C for warranty conditions

The *smart* alternative to panel radiators and underfloor heating.

Contents

1. Parts list & tools	4
2. Profiles	5
3. Feed pipes position	6
4. Cutting Skirting to Length	8
5. Mounting brackets/ Capping	10
6. Installation sequence	13
7. Installing thresholds & obstacles by pass kit (DOS)	18
8. Installing heated thresholds (POS)	20
9. Installing covers	24
10. Installing top gasket	25
11. Final checks	26
12. Running and trouble shooting	27
13. Bleeding your system	28
14. Alternative first fixes	29



Your ThermaSkirt system must be cleansed and protected by a corrosion inhibitor suitable for aluminium radiators, as required by BS 7593:2016 'Code of Practice for treatment of water in domestic hot central heating Systems'. DiscreteHeat recommends our own TS3 Cleanser and TS5 Inhibitor or Scale master CM5 or CM10.

FAILURE TO PROTECT YOUR SYSTEM WILL INVALIDATE YOUR WARRANTY

Typical ThermaSkirt-H2O parts list

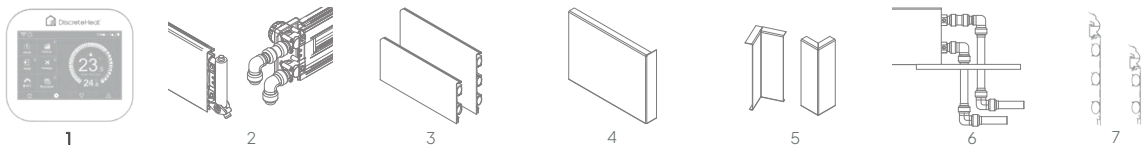

1. ThermaSkirt TM6 Thermostat (suggested)	4. Stainless Steel connections & termination covers	7. Capping (Optional)
2. Feed and return sets	5. Corner Connections (Internal, external or odd- angle)	
3. ThermaSkirt- H2O radiant panel (s)	6. Thresholds & Obstacle Kits	

Tools Required



1. A suitable metal cutting saw.	7. Various Push fit connectors.
2. DiscreteHeat rotary de-burring tool (Inc. in spares Kit).	8. Plastic or timber faced mallet.
3. An accurate quality tape measure (Grade 2 or better).	9. Raw plugs and/or plasterboard fixing with screws.
4. A Stanley knife/box cutter and/or plasterboard saw.	10. Pipe Cutting Tool.
5. Power drill with hammer action .	
6. Power screw driver/impact driver .	

Do's and dont's



DO Carefully check you have all the parts required by your design systems before you start cutting.

DO Check all skirting measurements twice before cutting: see diagram on page 8 (unless provided pre-cut).

DO Ensure that you use the templates to get your pipes correctly positioned.



DON'T Forget to check the orientation and quantity of retaining clips for each connection and fitting before you insert into skirting - it varies!

DON'T Forget that the FEED and RETURN pipes need to be tight to the wall to ensure your covers fit correctly.

ThermaSkirt-H²O Profiles

Deco BM2 and BM3 profiles can be fitted with optional capping to suit the decor & style required.



Feed Pipes Position BM2

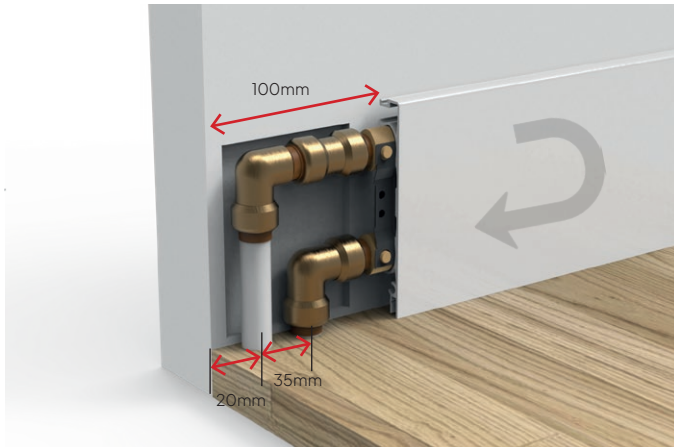

Clockwise Non TRV.

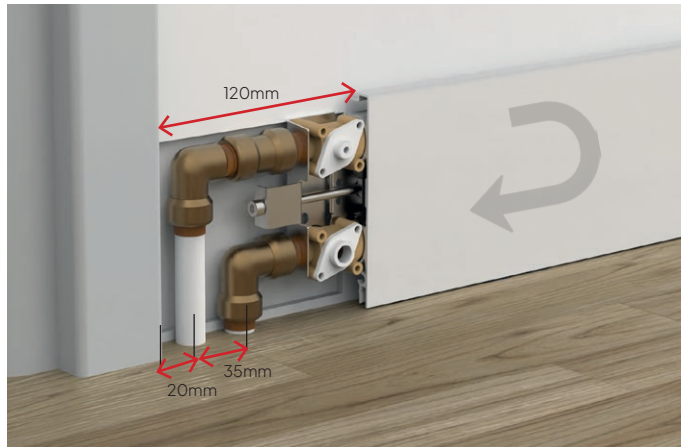

Clockwise with manual TRV.

Pipe connection should be set into the wall. For anti-clockwise dimensions and cutting allowances are the same but reverse direction

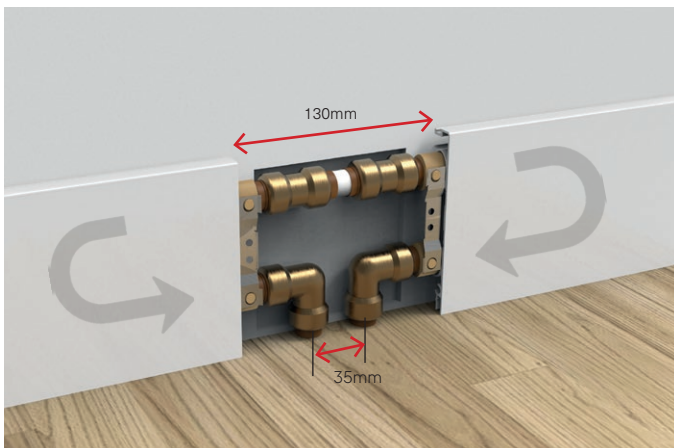

Bidirectional Non TRV

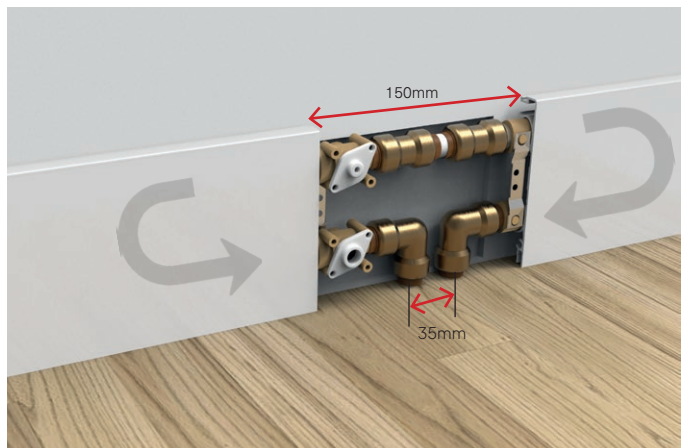

Bi- Directional TRV



NOTE: Relieve plastwork to a depth of 5mm to allow for fittings.



[Link to Video](#)

NOTE: Refer to templates on page 29 for through wall, from floor or pipes dropping from above.

Feed Pipes Position BM3

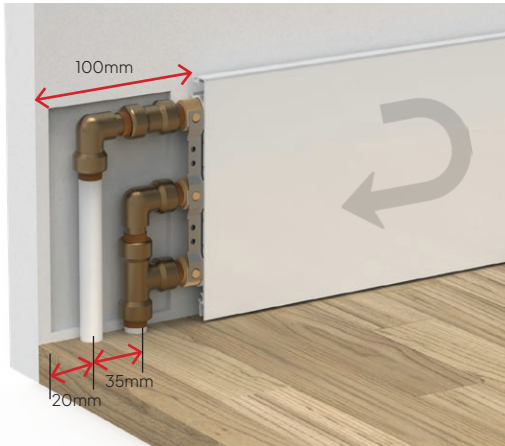
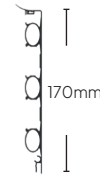

Clockwise Non TRV

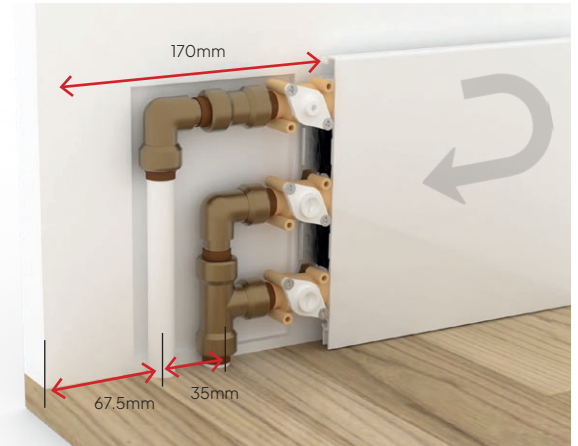

Clockwise Manual TRV

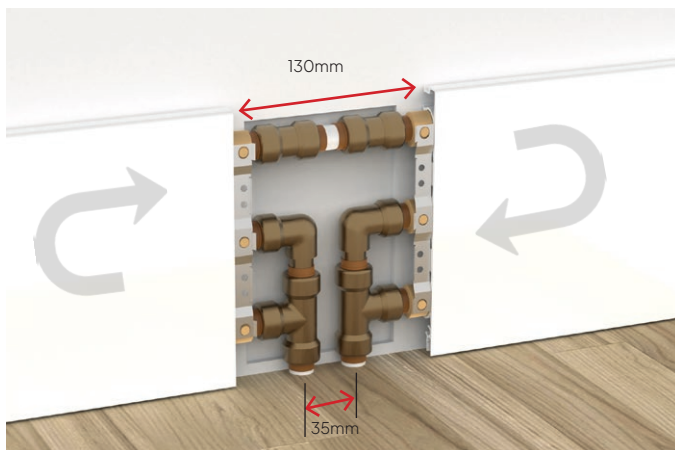

Bidirectional Non TRV

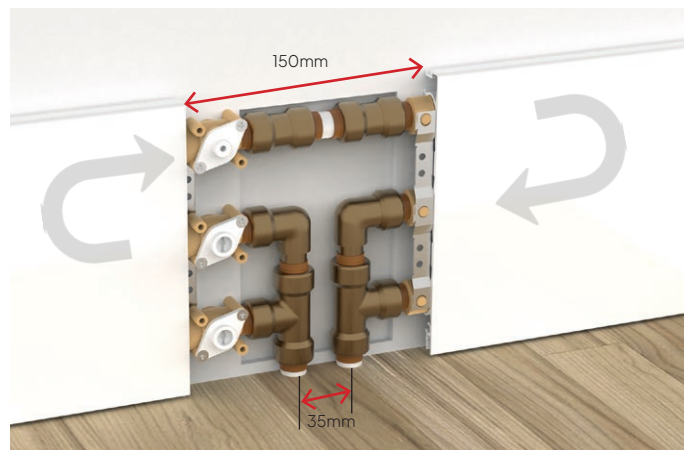

Bi- Directional TRV



NOTE: Relieve plasterwork to a depth of 5mm to allow for fittings.

NOTE: Refer to templates on page 29 for through wall, from floor or pipes dropping from above.

Cutting and installing the skirting - BM2

When cutting the ThermaSkirt panels, the following allowances should be made. Clockwise install shown: **for anti-clockwise install; mirror the dimensions.**

TRV Feed/Return	Internal Corner	External corner	Return manifold
Wall length MINUS -120mm/5"	Wall length MINUS -35mm/1.3", 20mm/0.80"	Wall length PLUS 0~3mm/0"	Wall length MINUS -60mm/2.4"
1x clip at back	1x clip at back	2x clip at front	1x clip at front
Non TRV feed & return / Threshold kit	Odd angle - internal	Odd angle - external	In - line joints > 4.5/6m
Wall length MINUS -100mm/4"	Offer flexible coupling up centrally to the internal corner and mark the wall at this point to give the cut length of skirting	Offer flexible coupling up centrally to the external corner and mark the wall at this point to give the cut length of skirting	Wall length MINUS -15mm/0.6"
1x clip at front	2x clip at front	2x clip at front	1x clip at front, 1x clip at back



Note: All cut ends must be de burred to preserve your warranty. Remove all chaff and debris to preserve your warranty. Problems may occur if not properly removed.

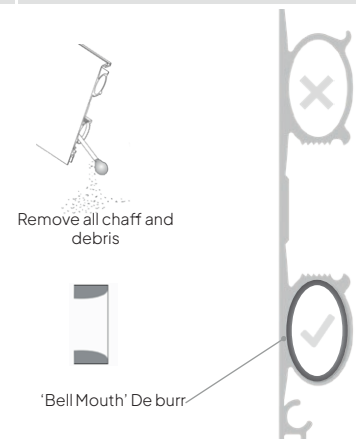

Cutting and installing the skirting - BM3

When cutting the ThermaSkirt panels, the following allowances should be made. Clockwise install shown: **for anti-clockwise install; mirror the dimensions.**



TRV Feed/return	Internal Corner	External corner	Return manifold
Wall length MINUS -170/6.7"	Wall length MINUS -35mm/1.3", -20mm/0.8"	Wall length PLUS 0~3mm/0"	Wall length MINUS -170mm/6.7"
2x clip at back	2x clip at back	4x clip at front	2x clip at front
Non TRV feed & return / Threshold kit	Odd angle - internal	Odd angle - external	In - line joints > 4.5/6m
Wall length MINUS -100mm/4"	Offer flexible coupling up centrally to the internal corner and mark the wall at this point to give the cut length of skirting	Offer flexible coupling up centrally to the external corner and mark the wall at this point to give the cut length of skirting	Wall length MINUS -15mm/0.6"
2x clip at front	4x clip at front	4x clip at front	2x clip at front, 2x clip at back

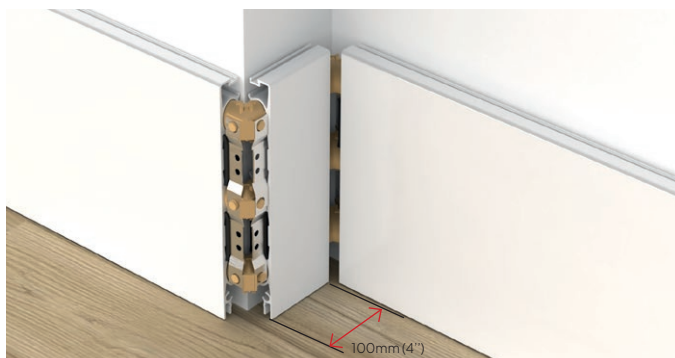

NOTE: Minimum active length = 100mm (4").



Link to Video

Mounting Brackets

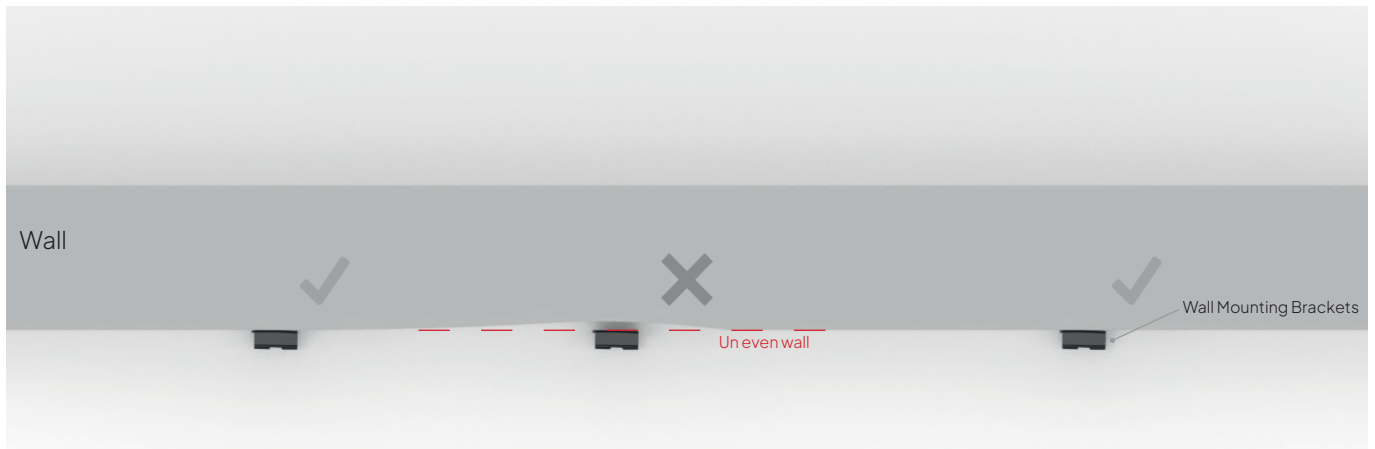

3. Fix Brackets on the high spots on the wall.

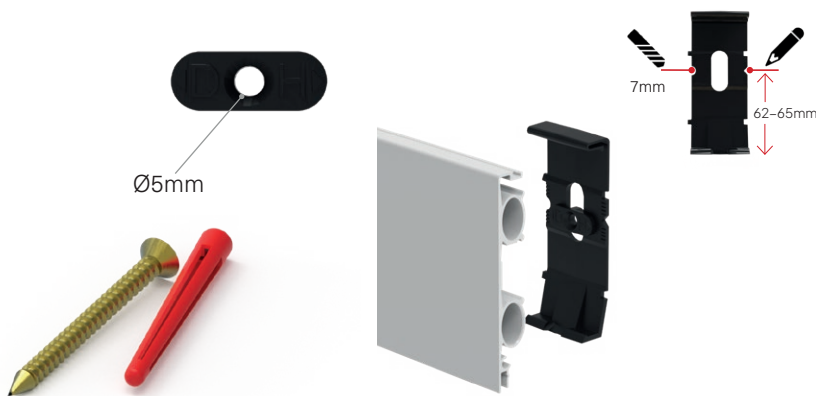

Use suitable Wall fixing. (Not supplied)

Use this mark to position mounting bracket using an off-cut of skirting then drill or mark with pencil.

Suggested

Skirting Length	Number of Brackets
1m	2
2 - 3 m	3
3 - 4 m	4
4 - 5 m	5
5 - 6 m	5/6



[Link to Video](#)

Mounting Brackets Continued

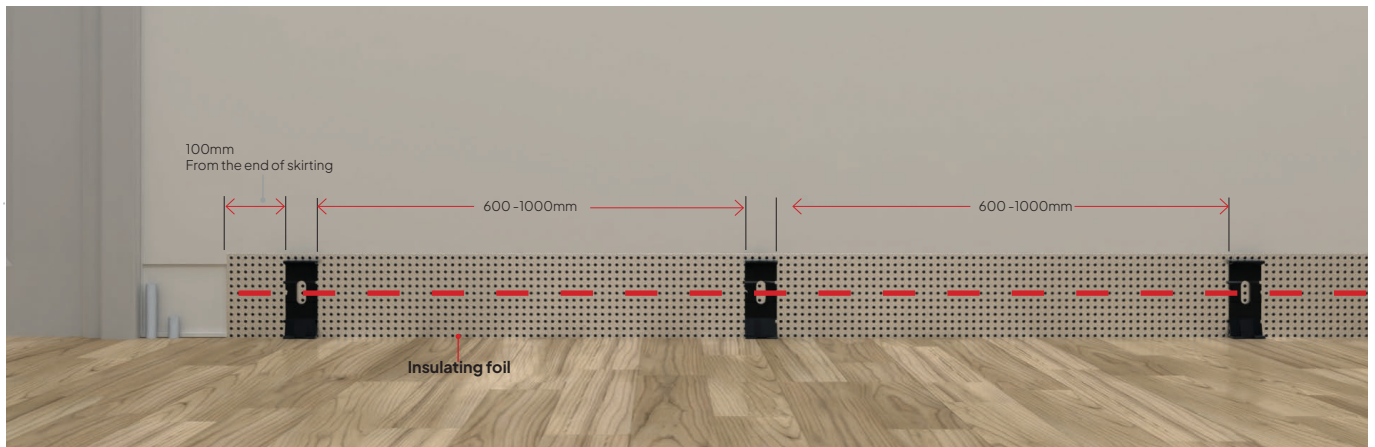

BM2

Use the insulation foil provided before fixing the brackets and ensure they are separated 600-1000mm apart.

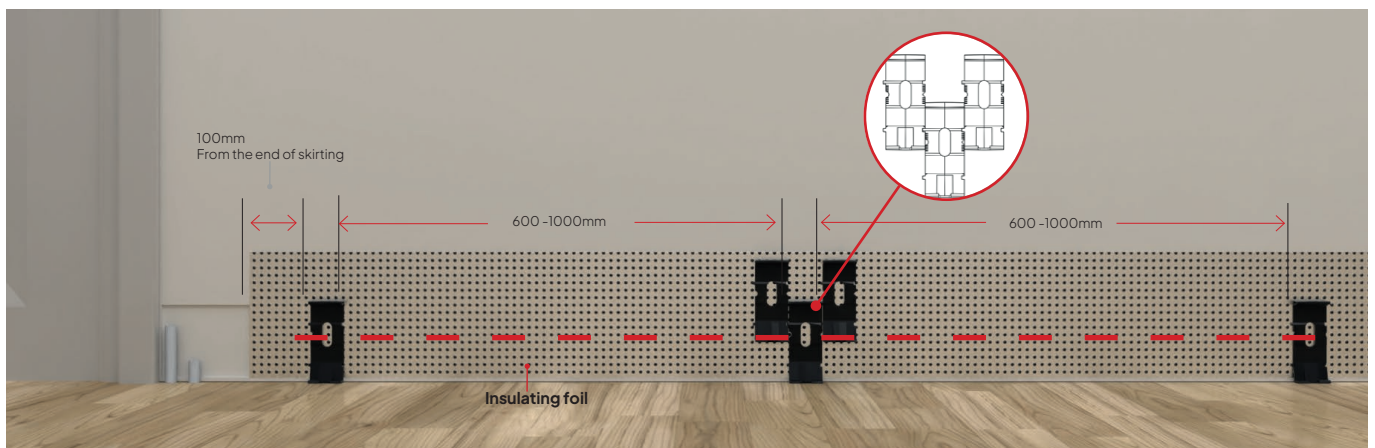

BM3

Use the insulation foil provided before fixing the brackets and ensure they are separated 600-1000mm apart.

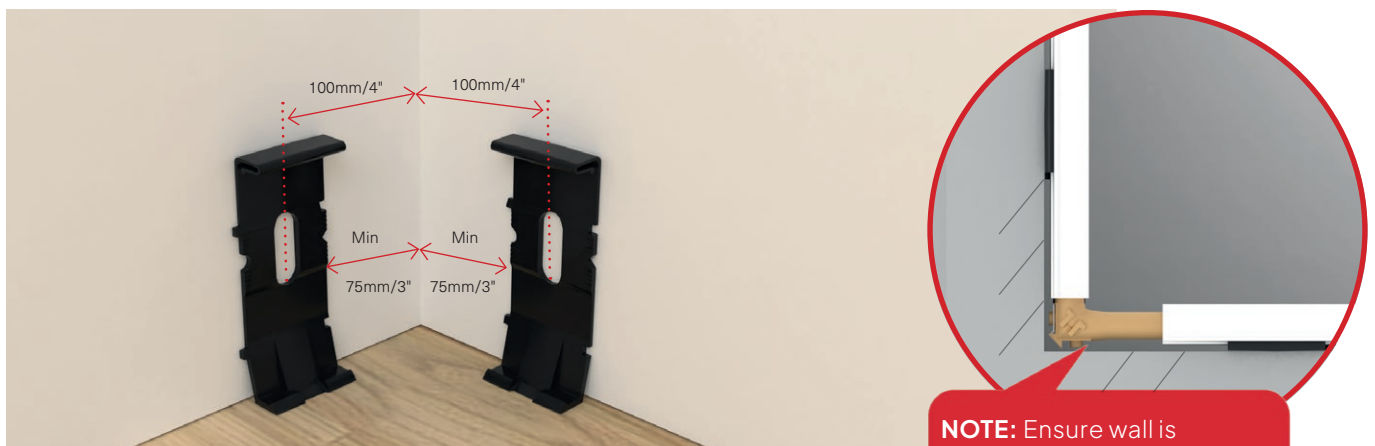

Internal Corners: Fix brackets 100mm/4" away from the wall.

Installing the capping – (Alternative mounting)



Install the feet 100mm from the start of the skirting.

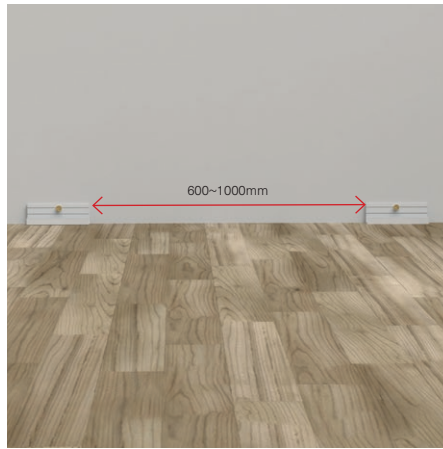

Install each feet 600 ~ 1000 mm apart.



Slide the skirting into the feet as shown.



Mounting rail should be clicked onto the skirting, Also securing to the wall using appropriate fixing every 600-1000mm.



Internal Corners: Capping should be butt and scribed



External Corners: The capping should be mitred.

Installing the first section (BM2 & BM3)

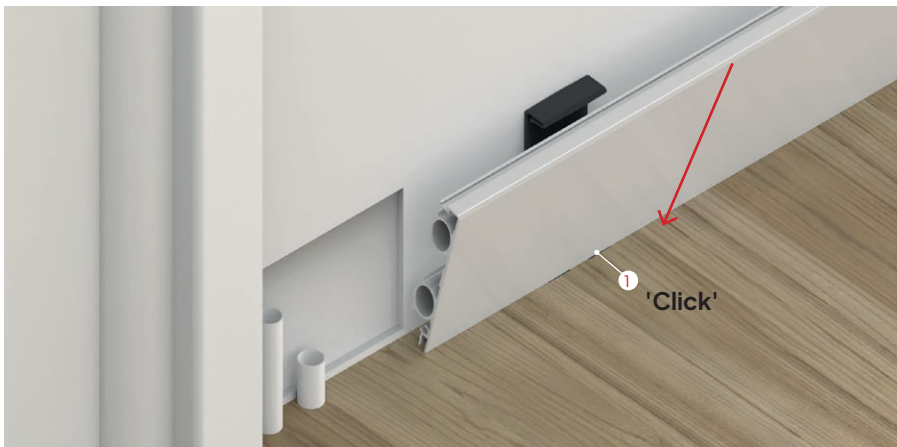

To attach the skirting to the bracket pivot the skirting onto the bracket feet until you hear a click.

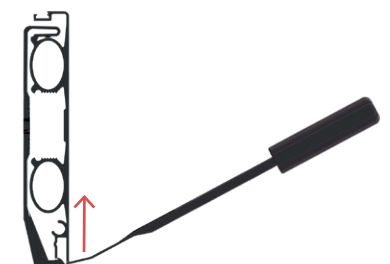
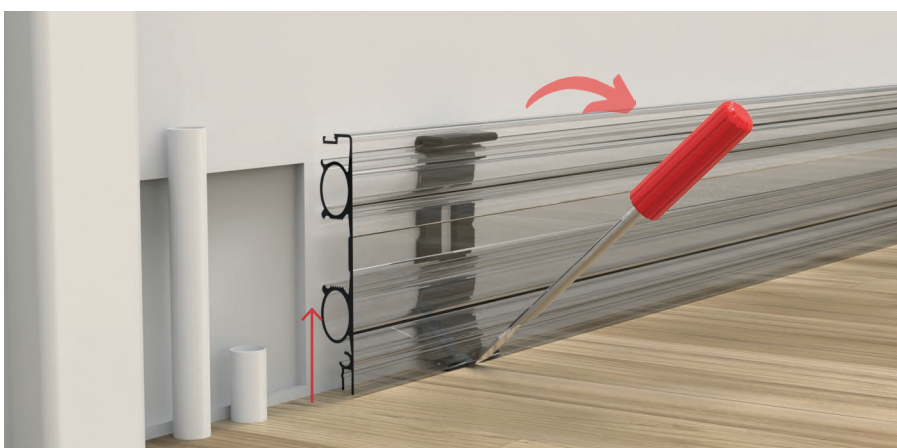
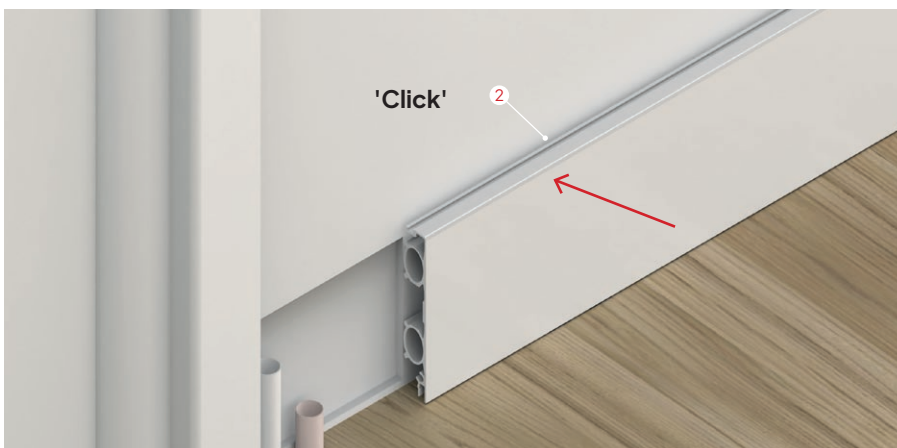

To detach the skirting from the bracket insert pry bar or similar at the bottom and pop the skirting off the bracket.

Installation Sequence BM2

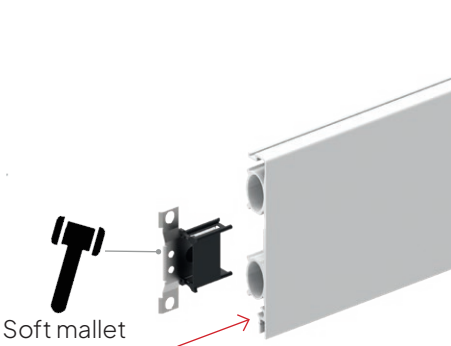

Insert the connector clip into the skirting. Gently hammer the clip into the groove in-between the pipes.

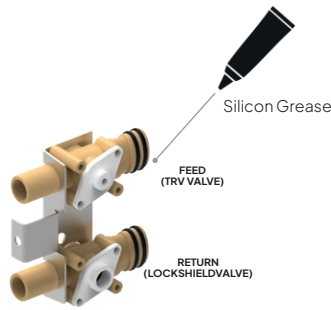

Grease the TRV Valve and lock shield.

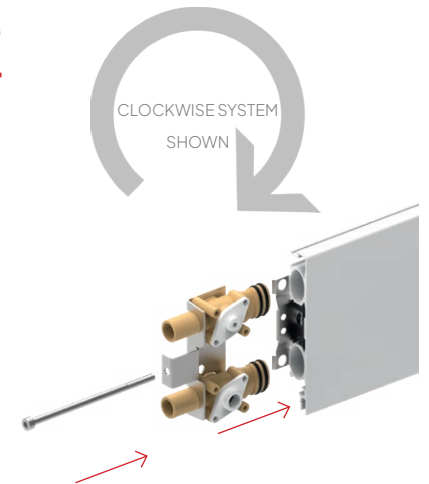

Push fit the TRV valve and lock shield into the pipes.

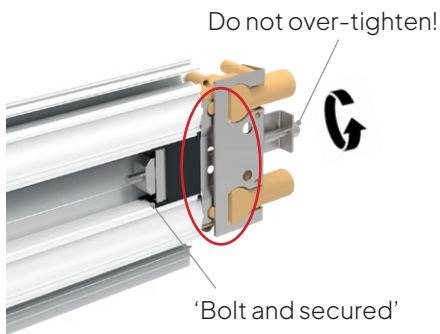

TOP TIP: TRV Brackets must over lap the connector clip. (See image 4)

Use the TRV cage bolt to secure the lock shield and TRV valve.

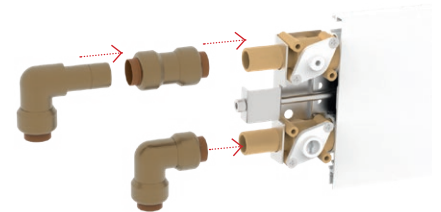

Insert tectites to the oval to rounds.

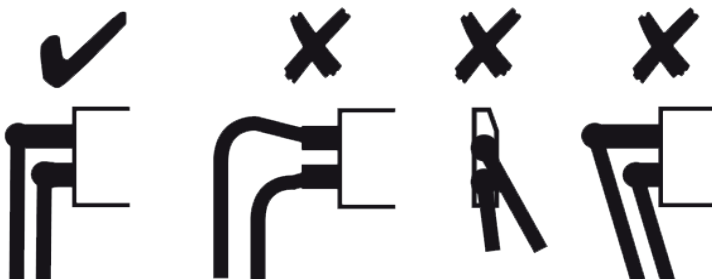

Note: Ensure pipes are vertical and square to the skirting!.

Note: Grease supplied must be used on all connection to avoid damage on assembly and preserve your warranty.



[Link to Video](#)

Installation Sequence BM2 Continued

Internal Corners: Clockwise install shown 

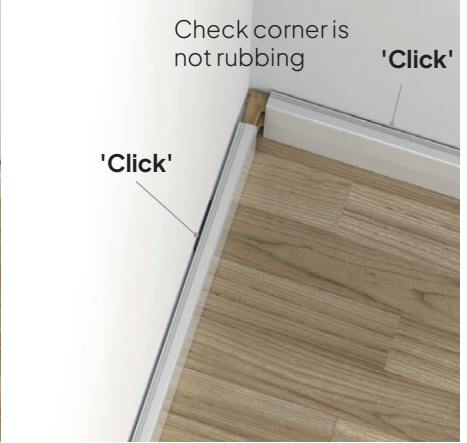
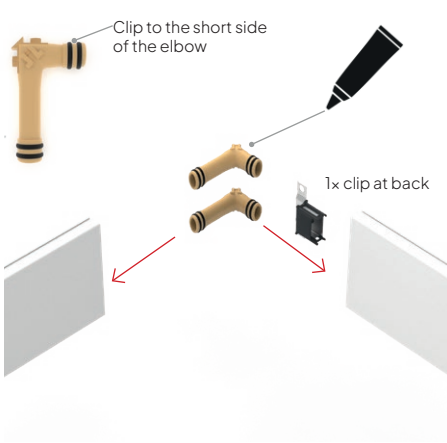

'O' Rings must be greased. 

External Corners:

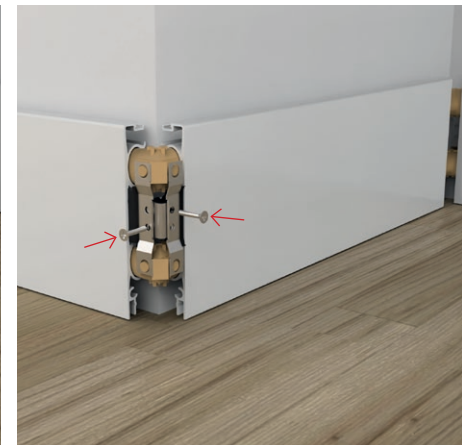
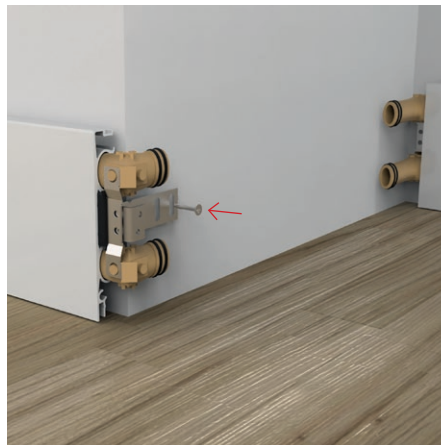
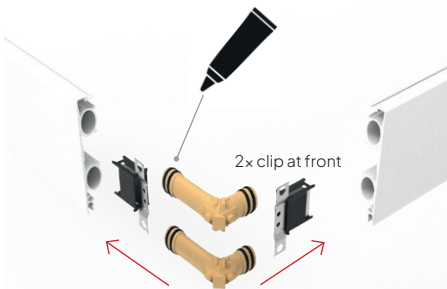

'O' Rings must be greased. 

Return Manifold /End of Run:

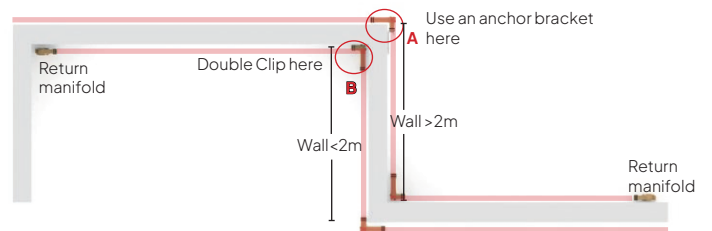
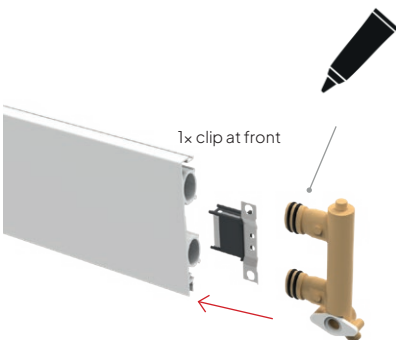

TOP TIP: Avoid detachment at external corner.
A. If the skirting is more than 2m and running from an external corner to an internal corner you must use an anchor bracket to secure in place.
B. If skirting is less than 2m you should double clip the internal corner.

Installation Sequence BM3

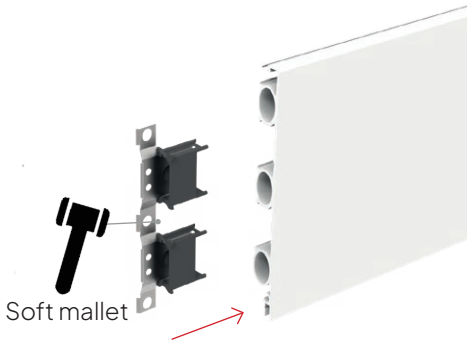

Insert the 2 x connector clip into the skirting. Gently hammer the clip into the groove in-between the pipes.

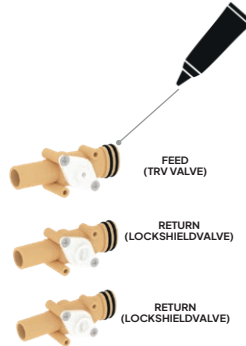

Grease the TRV Valve and lock shield.

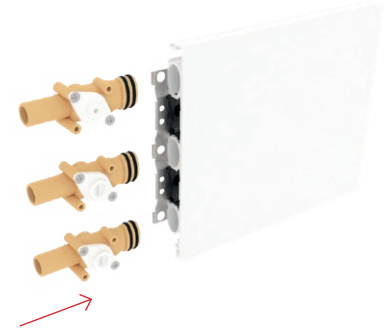

Push fit the TRV valve and lock shield into the pipes.

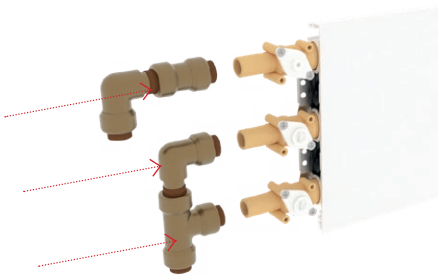

Insert tectites to the oval to rounds.



Ensure both sides are level to each other.

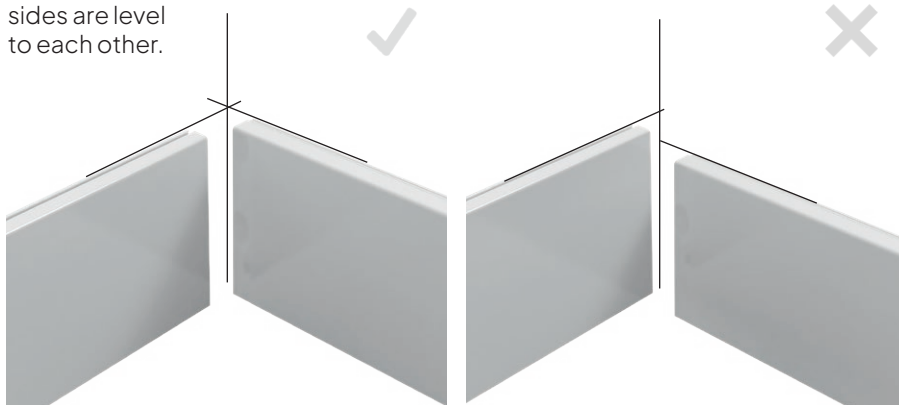

Note: Ensure the skirting are vertical and square.

Installation Sequence BM3 Continued

Internal Corners: Clockwise install shown

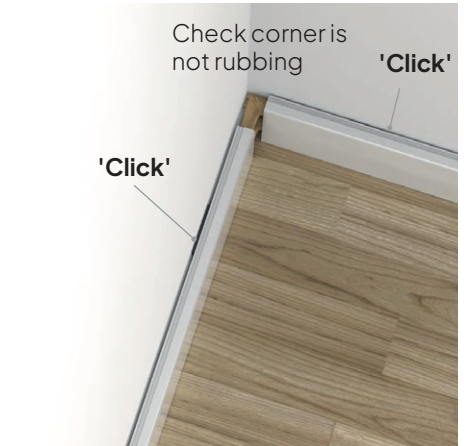
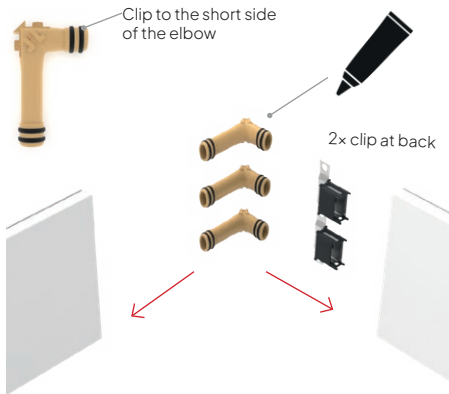

'O' Rings must be greased.

External Corners:

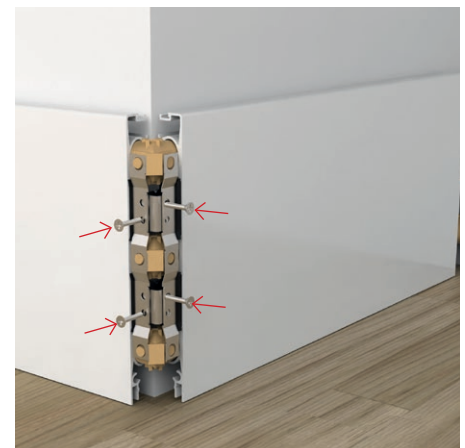
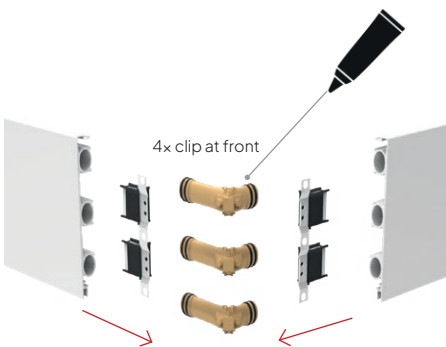

Return Manifold /End of Run:

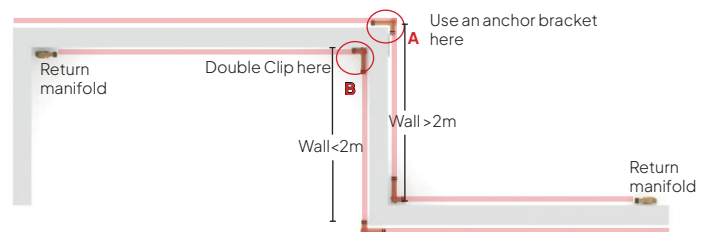
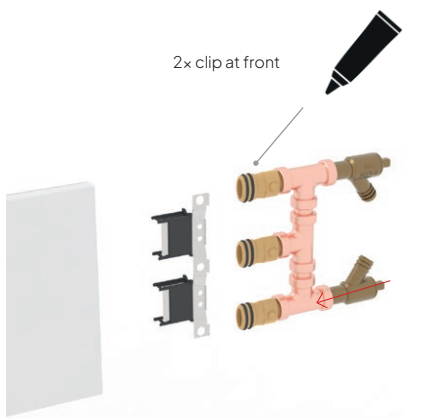

TOP TIP: Avoid detachment at external corner.
A. If the skirting is more than 2m and running from an external corner to an internal corner you must use an anchor bracket to secure in place.
B. If skirting is less than 2m you should double clip the internal corner.

Installing Thresholds - BM2

The threshold kit is used to join two sections of ThermaSkirt when crossing a doorway, arch or fireplace, etc. Ensure that feed and return pipes are installed correctly (Obtain a template from <https://www.discreteheat.com/instructions.aspx>) making sure you allow for carpets or tiles if not Finished Floor Level (FFL).

Your pipework (Not Supplied), connecting the two ends of skirting, can either go below suspended timber beams or can be channelled into the hard floor.



Suspended Timber Floor: Use continuous flexible pipe if possible.

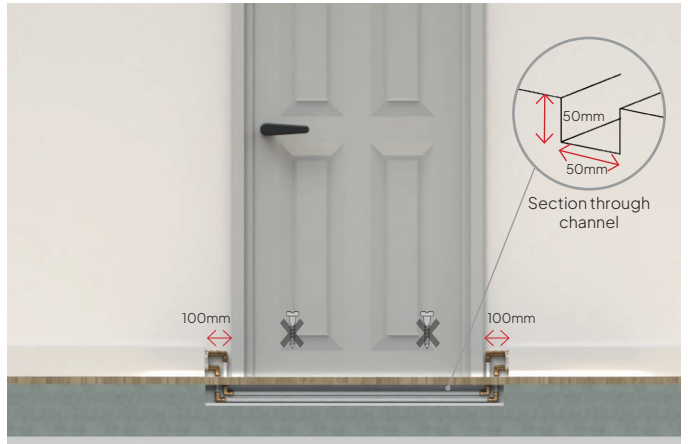

Solid/Beam and Block Floor:

The channel must be at least 50mm deep x 50mm wide and it is most important that NO drilling or fittings, such as carpet grippers be used in this area.

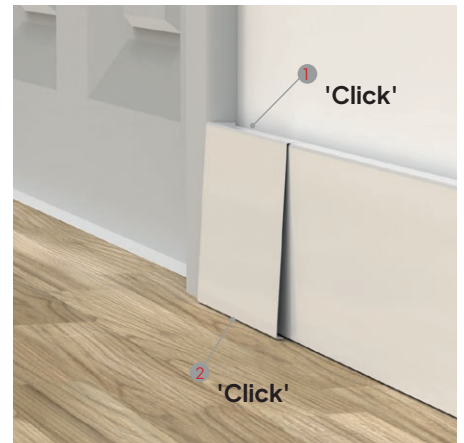
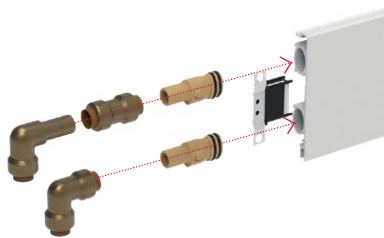

Remove 100mm of the skirting on each of the threshold to allow for fittings and covers. Fit a connector clip to each end of skirting, making sure that it will engage with straight connectors at the front.

Slide the two ends of skirting over the two straight connectors, ensuring the lugs engage correctly at the front.

Finish by fitting a left and right hand threshold cover by clipping on top, swing and clip under

Top Tip: When installing into a doorway or conservatory entrance, use a 'dry section' of ThermaSkirt in the short length of wall to complete the look. For this arrangement you will need an alternative cover. Special Threshold covers may be required.

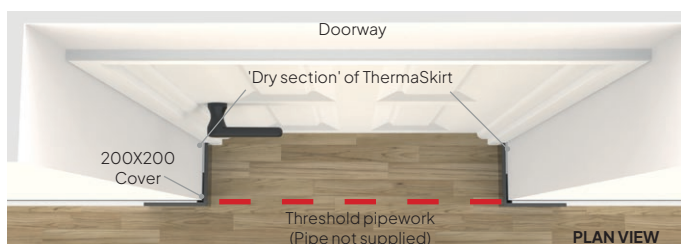

Installing Thresholds - BM3

Your pipework (Not Supplied), connecting the two ends of skirting, can either go below suspended timber beams or can be channelled into the hard floor.



Suspended Timber Floor: Use continuous flexible pipe if possible.

Note: BM3 converts back to 2 pipes to make the connection.

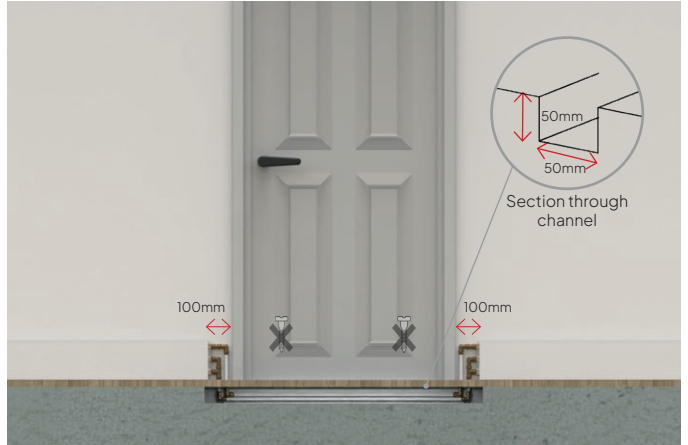

Solid/Beam and Block Floor:

The channel must be at least 50mm deep x 50mm wide and it is most important that NO drilling or fittings, such as carpet grippers be used in this area.

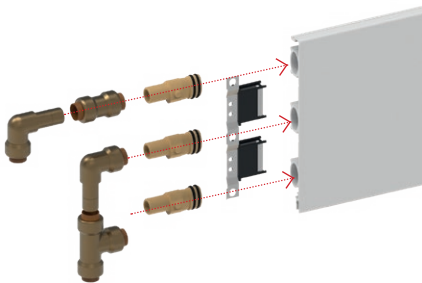

Remove 100mm of the skirting on each of the threshold to allow for fittings and covers. Fit a connector clip to each end of skirting, making sure that it will engage with straight connectors at the front.



Slide the two ends of skirting over the two straight connectors, ensuring the lugs engage correctly at the front.



Finish by fitting a left and right hand threshold cover by clipping on top, swing and clip under

Top Tip: When installing into a doorway or conservatory entrance, use a 'dry section' of ThermaSkirt in the short length of wall to complete the look. For this arrangement you will need an alternative cover. Special Threshold covers may be required.

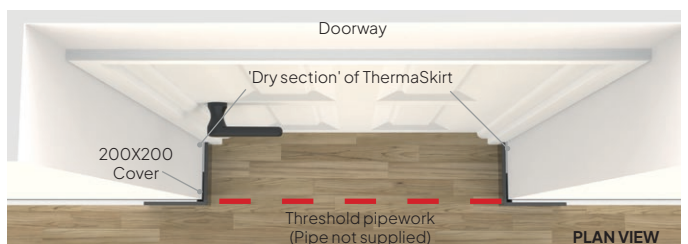

Installing Heated Thresholds - BM2

For reveals less than 250mm:



Mark 117 mm width and 20 mm depth channel on the floor close to the by-fold or patio door.

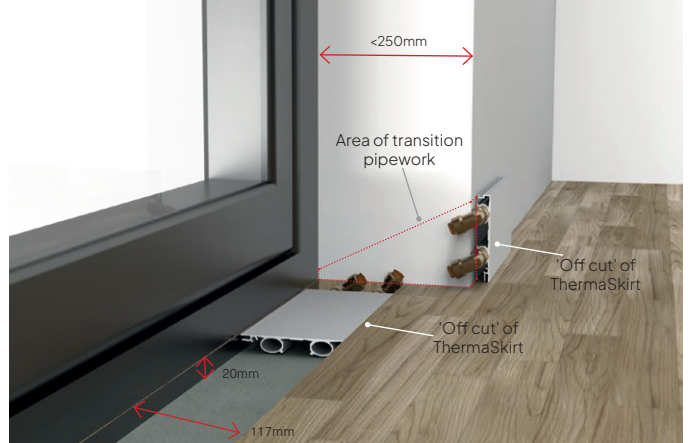

Place an offcut of skirting into the channel and wall, creating a transition jig. Mark the area of angle and profiles of the transition pipes.



Relieve the plasterwork, allow enough room for the tectite to fit flush to the wall.

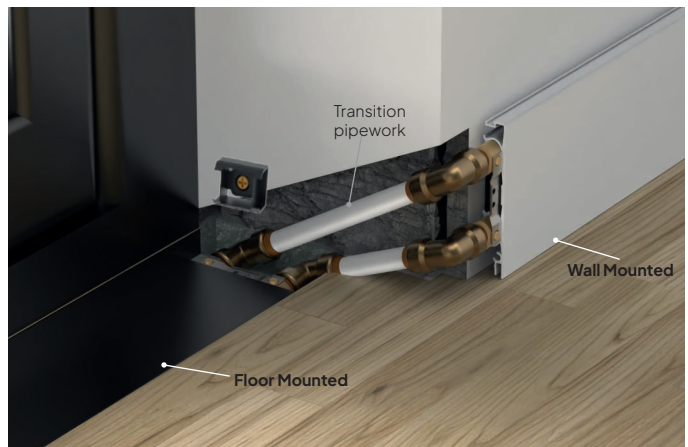

Install the floor and wall mounted Skirting, both connected via the transition pipes (Not Supplied).



Use a 'dry section' of ThermaSkirt in the short length of wall to complete the look.

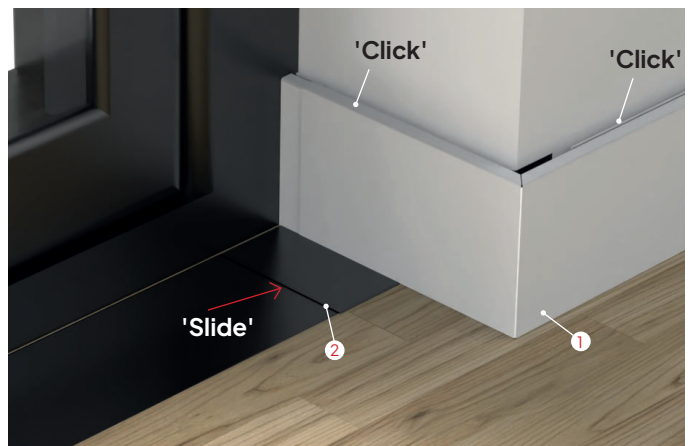

Use a special Threshold cover to conceal the plasterwork and slide an open ended cover at the floor mounted intersection.

TOP TIP: Silicone seal between covers and door frame.

Installing Heated Thresholds - BM2

For door reveals larger than 250mm:



Mark 117 mm width and 20 mm depth channel on the floor close to the by-fold or patio door.

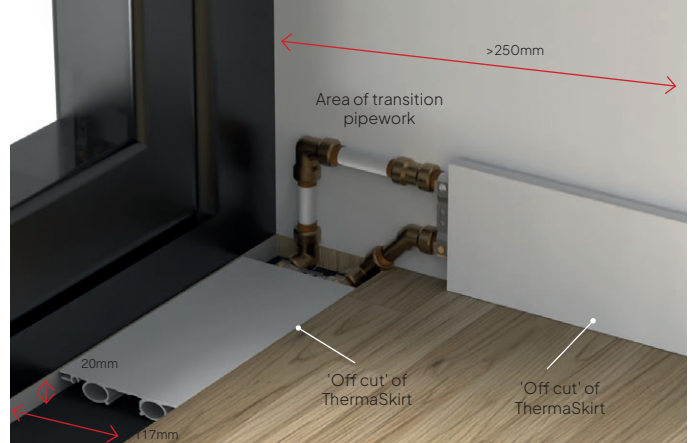

Using offcuts and connectors, Create a transition model as shown. Sections of pipes must be used for the connection (Not Supplied).

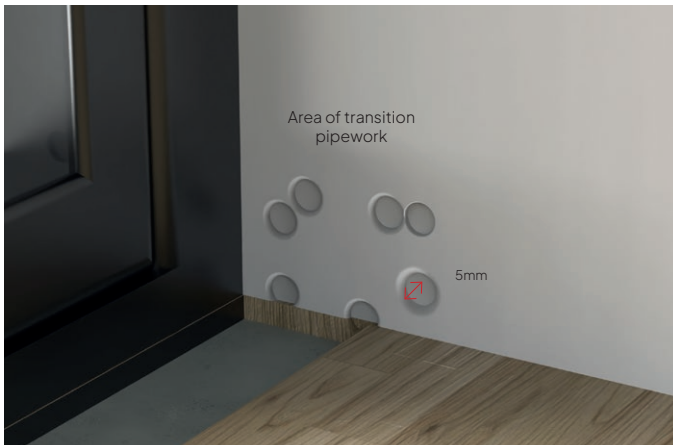

Relieve the wall 5mm as shown for the tectites to sit flush to the skirting, this ensures the flawless fitting of covers.

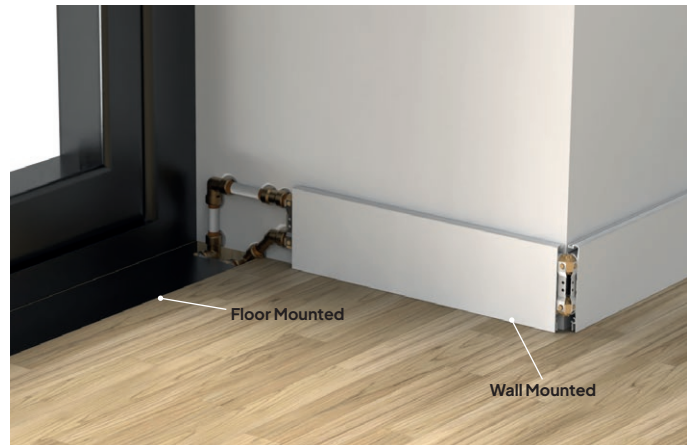

Install the floor and wall mounted Skirting, both connected via the transition pipes.

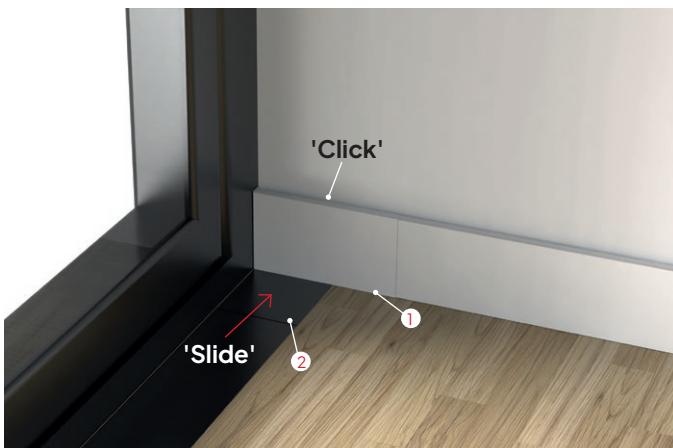

Use a close ended Threshold cover to conceal the plasterwork and slide an open ended cover at the floor mounted intersection.

TOP TIP: Silicone seal between covers and door frame

Installing Heated Thresholds - BM3

For door reveals less than 250mm:



Mark 117 mm width and 20 mm depth channel on the floor close to the by-fold or patio door.

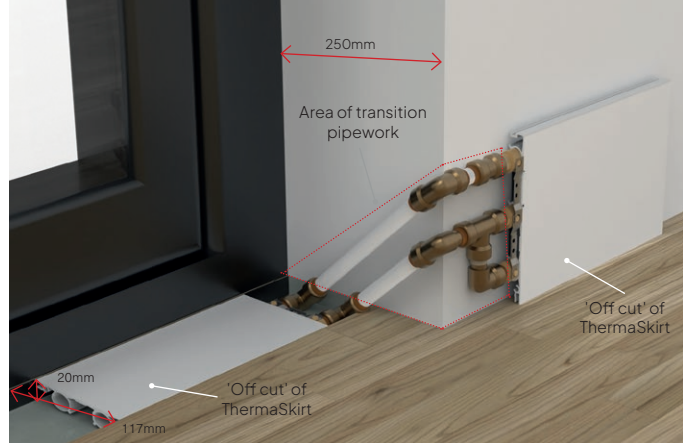

Place an offcut of skirting into the channel and wall, creating a transition jig. Mark the area of angle and profiles of the transition pipes.



Relieve the plasterwork, allow enough room for the tectite to fit flush to the wall.

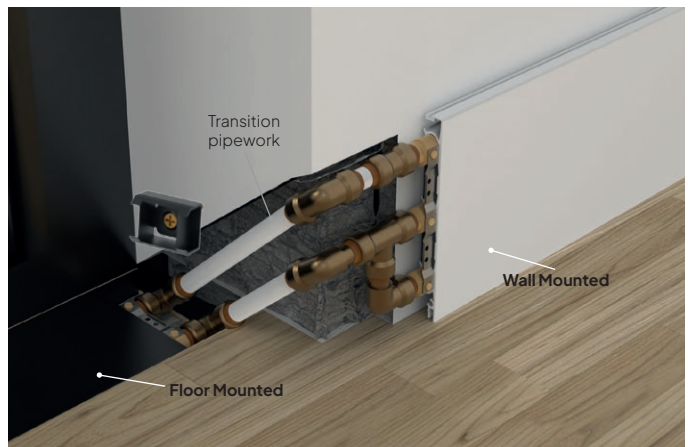

Install the floor and wall mounted Skirting, both connected via the transition pipes.



Use a 'dry section' of ThermaSkirt in the short length of wall to complete the look.

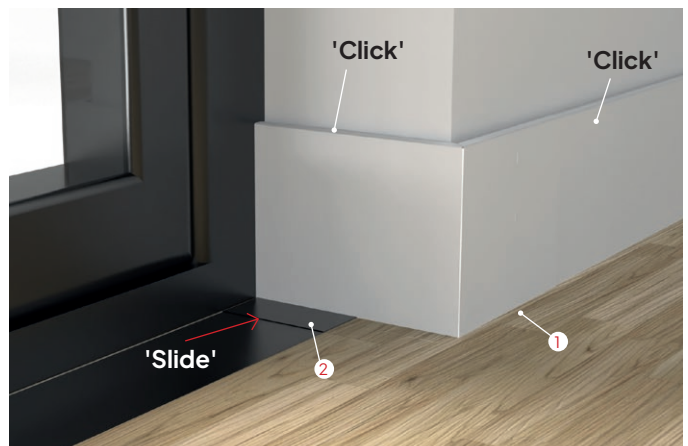

Use a special Threshold cover to conceal the plasterwork and slide an open ended cover at the floor mounted interjection.

TOP TIP: Silicone seal between covers and door frame.

Installing Heated Thresholds - BM3

For reveals larger than 250mm:



Mark 117 mm width and 20 mm depth channel on the floor close to the by-fold or patio door.

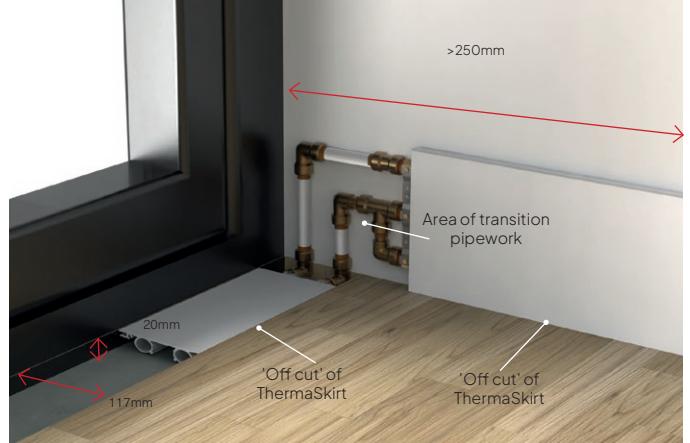

Using offcuts and connectors, Create a transition model as shown. Section of pipes must be used for the connection (Not supplied).

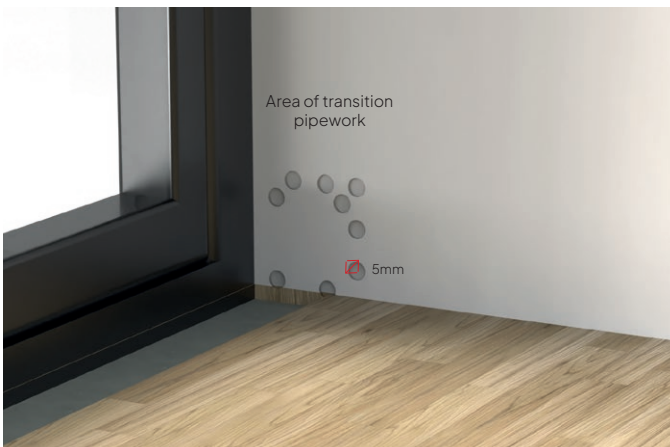

Relieve the wall 5mm as shown for the tectites to sit flush to the skirting, this ensures the flawless fitting of covers.

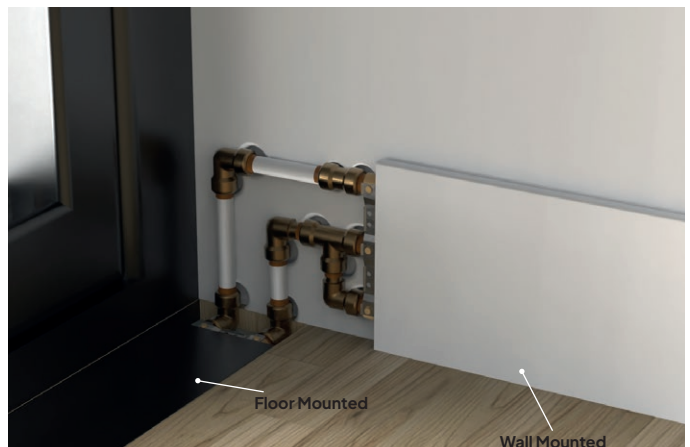

Install the floor and wall mounted Skirting, both connected via the transition pipes.

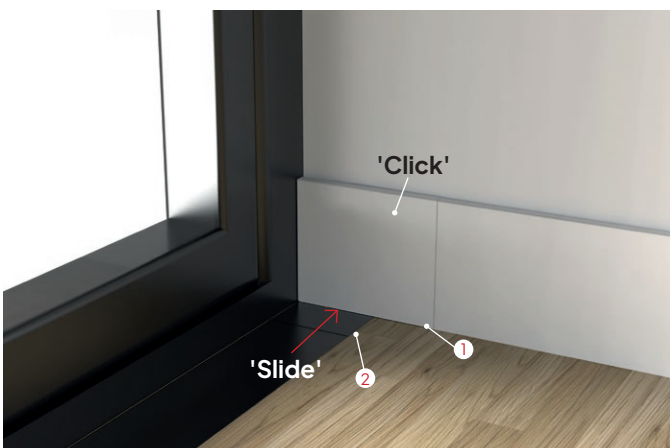

Use a close ended Threshold cover to conceal the plasterwork and slide an open ended cover at the floor mounted intersection.

TOP TIP: Silicone seal between covers and door frame

Installing Covers

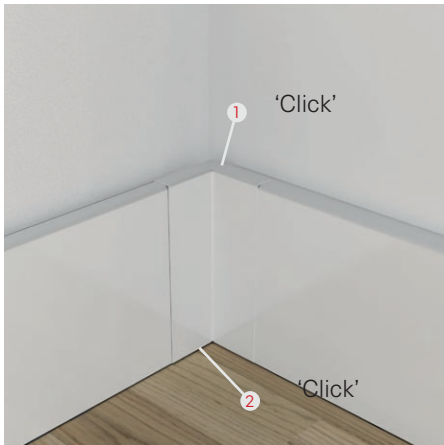

Internal Corner
1. Clip on top
2. Swing and clip under



External Corner
1. Clip on top Edge
2. Swing and clip under



Return Manifold
1. Clip on Top
2. Swing and clip under

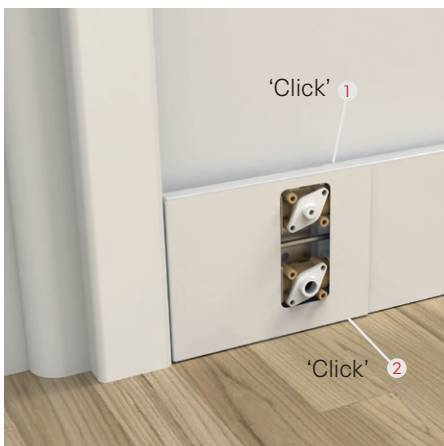

TRV Cover
1. Clip on Top
2. Swing and clip under



Insert the wax element into the TRV valve before fitting the TRV knob. **Do not forget the white spacer!**

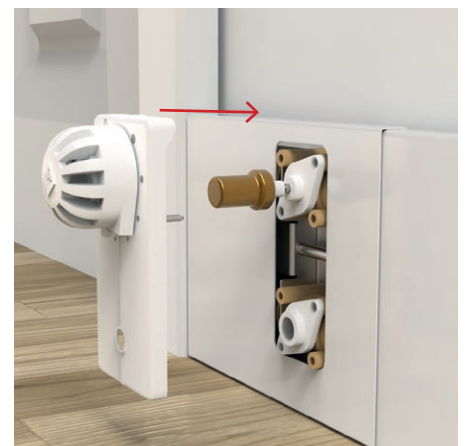

Insert the TRV valve facia

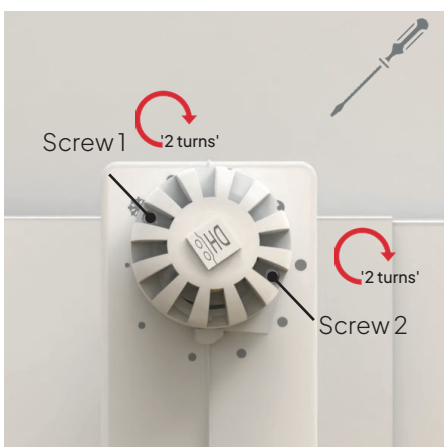

Position the holes in knob as shown to access 2 fixing screws for TRV controls.

Tighten the facia screws 2 turns in sequence. (Using a small flat blade screwdriver.)



[Link to Video \(Covers\)](#)



[Link to Video \(Valve Facia\)](#)

Installing the top gasket

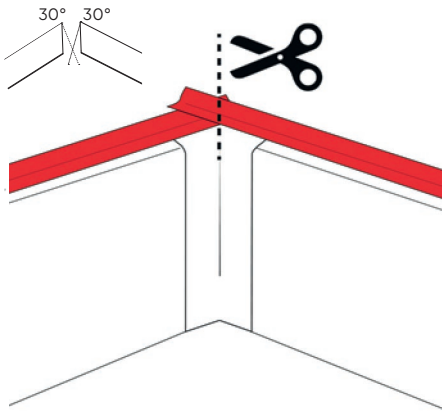

Ensure the top gasket is mitred $\approx 30^\circ$ (when it comes to corners) after fitting the corner cover.

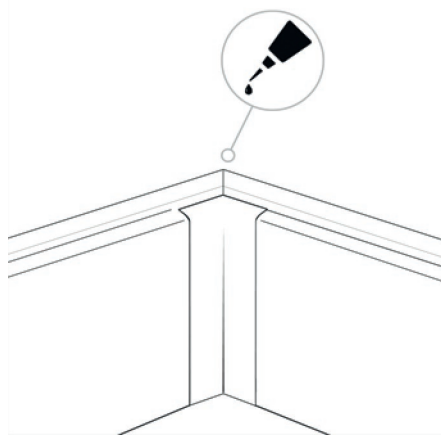

Add a touch of super glue (activation spray can be beneficial) onto the mitre before fitting to the corner cover.

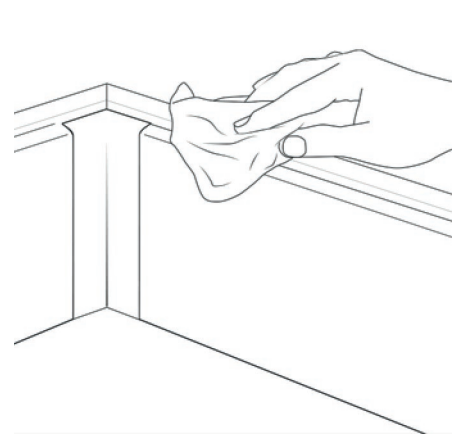

To assist installation of the gasket, use a wet wipe before and after insertion.



[Link to Video](#)

Final Checks

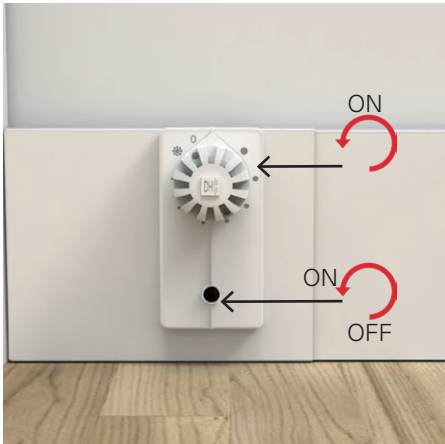

TRV Controls

Clockwise = **CLOSED**
 Anticlockwise = **OPEN**

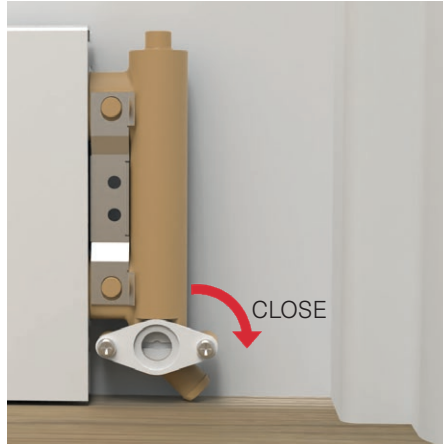

Return Manifold BM2: Clockwise Installation

Clockwise = **CLOSE**
 Anticlockwise = **DRAIN**

Use correct size screwdriver 1/4" (6.5mm) to avoid damage

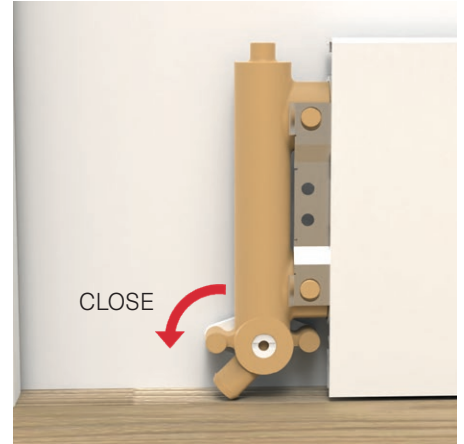

Return Manifold BM2: Anti clockwise Installation

Use correct size screwdriver 1/4" (6.5mm) to avoid damage

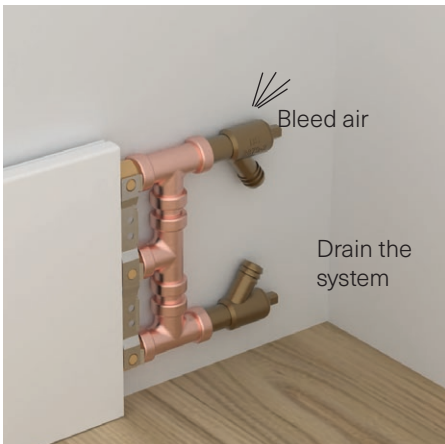

Return Manifold BM3:

To bleed air:
 Clockwise = **CLOSE**
 Anticlockwise = **OPEN**

To drain the system:
 Clockwise = **CLOSE**
 Anticlockwise = **OPEN**



A pressure test of the system before connecting to the central heating system is recommended. (See part no. TTEST)

Pressure test : Recommended 3 Bar for 1 hour Max test pressure 10 Bar

Warning : if testing with water, do not leave untreated water in the system after testing as this may invalidate your warranty.

If leaving filled, protection against corrosion in accordance with BS EN 7593:2016 must be used.



Running Your System

Run the system at fully open, maximum temperature for 1 hour, to expel any air in the system. Release any air that may be trapped at appropriate radiator bleed points and return manifold bleed point. Turn off TRV/flow manifold and allow to cool. Set to desired room setting and run normally.

NOTE: DiscreteHeat recommend flushing the system with ThermaSkirt Cleanser TS3 or alternatively Scale master SM3 (check dosage carefully) and running with ThermaSkirt corrosion inhibitor TS5 or alternatively Scale master SM5 or SM10 (check dosage carefully) to ensure maximum longevity and reliability. Hard water areas may require additional precautions. Chemically softened water must NOT be used. This is a standard precaution for ALL wet heating systems and a requirement of BS 7593:2016. Contact DiscreteHeat for specific application advice.

Failure to provide a suitable corrosion inhibitor will invalidate your warranty!

Trouble Shooting

Problem	Cause	Solution
Leak at joint. Leak on ThermaSkirt pipes.	Faulty / incorrect installation. No inhibitor fitted. Corrosion chemical/cleaner left in system	Drain and replace fitting or 'O' ring from spares kit. Drain down, cleanse with TS3 And install inhibitor TS5. Drain down, replace piece, cleanse with TS3 and refill.
ThermaSkirt not hot.	Check boiler. Lock shield valve closed. TRV valve closed / off. Air trapped in pipework.	Is heating 'ON' and pressure OK? Open Lock shield valve (☉). Open TRV valve (☉). See 10 below.
Water from return manifold	Manifold not closed fully.	Turn to ' OFF ' position.
Noise - ticks & clicks when heating and cooling	Connectors & fittings rubbing on wall.	Relieve plasterwork at Feed & Return and/or corner fittings. Check bracket positions (See page 11).
Sudden 'bangs'	ThermaSkirt length(s) cut too long, Expanding and jumping off the bracket. Internal corners clipped both sides.	Check lengths & refit if necessary. Check & remove/ UN clip unnecessary clip.



[Link to Video
\(Commissioning\)](#)



[Link to Video
\(Balancing\)](#)

Bleeding Your System

As ThermaSkirt® acts like a pipe, in normal operation air does not get trapped. However, on existing systems, to which ThermaSkirt® is added, air may get trapped in the existing pipework to and from the skirting. Follow these simple steps if you discover cold sections of the ThermaSkirt which do not heat up.

1. System with ThermaSkirt® & Conventional Radiators

Turn off all radiators and ThermaSkirt thermostatic and lock shield valves except one radiator. Make sure your system is fully pressurized and the pump is set to max. Run the system for a few minutes, and, starting from the lowest point in the house, open each Radiator/ThermaSkirt system, one at a time. Run for a further 10 minutes (approx), close again and move to the next ThermaSkirt or radiator, moving upwards in the house. Any air will be expelled through the boiler or trapped in a conventional Radiator. Bleed the radiator as normal.

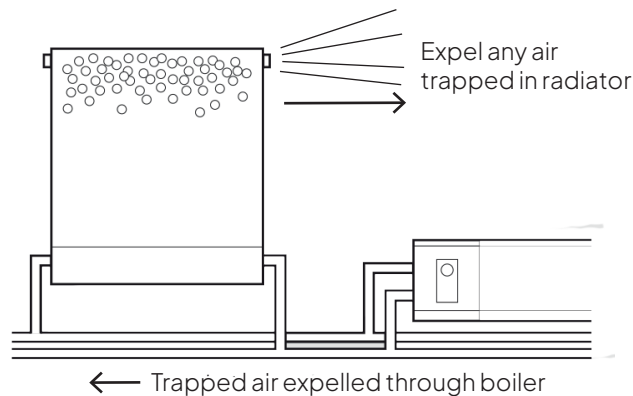

2. New Installation with ThermaSkirt® Only.

On installation, in a convenient place at the highest point of the system, 'T' off into a vertical leg 600mm high and install an automatic/manual air vent.

Following the procedure above, close and open each ThermaSkirt® system in turn.

Any air forced round the system will be expelled through the boiler or through the air vent. Air can also be bled from the bleed screw on top of the return manifold (A).

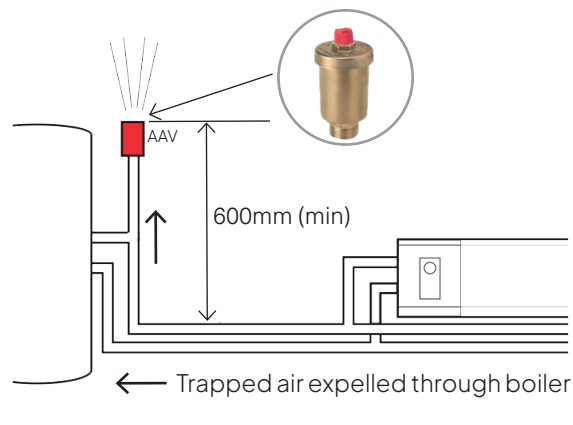

Alternative First fixes For anti-clockwise installation; mirror the connections

BM2 Clockwise Non TRV Templates.

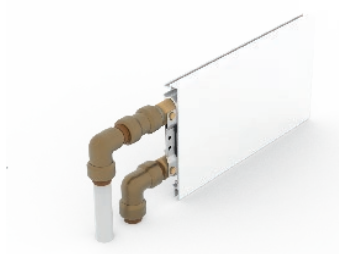

Pipes through floor

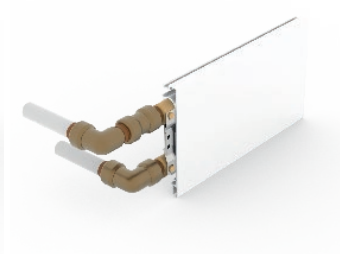

Pipes through wall



Pipes dropping from above
(Cavity wall)



Pipes dropping from above
(Solid wall)

BM2 Clockwise TRV Templates.

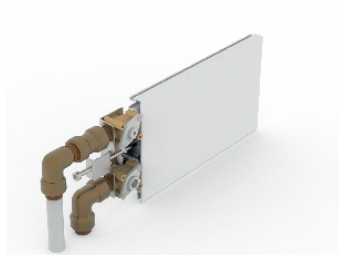

Pipes through floor

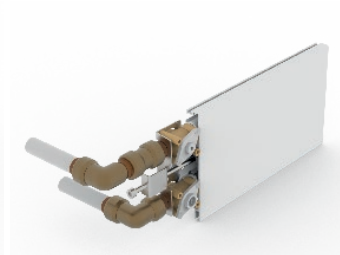

Pipes through wall

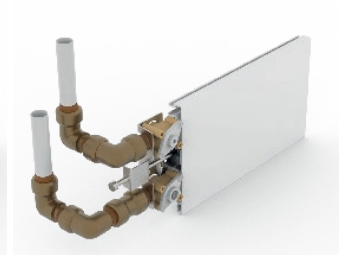

Pipes dropping from above
(Cavity wall)

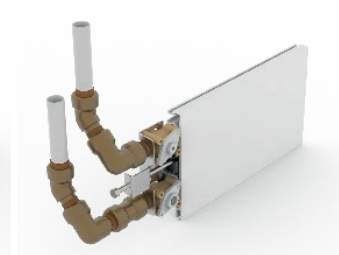

Pipes dropping from above
(Solid wall)

BM2 Bidirectional Non TRV Templates.



Pipes through floor

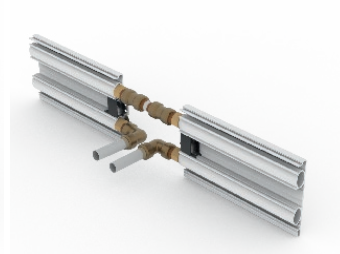

Pipes through wall

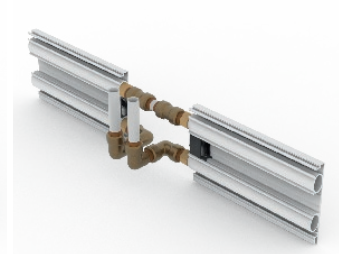

Pipes dropping from above
(Cavity wall)

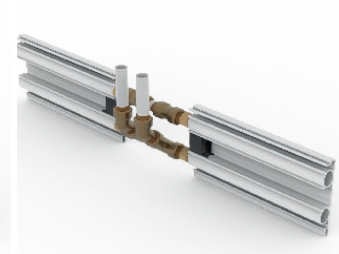

Pipes dropping from above
(Solid wall)

BM2 Bidirectional TRV Templates.

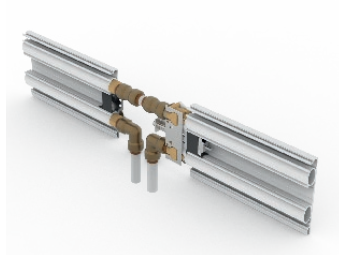

Pipes through floor

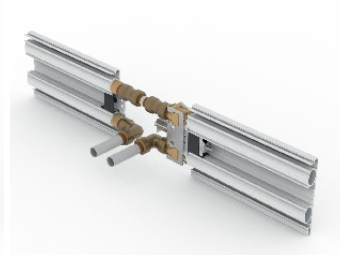

Pipes through wall

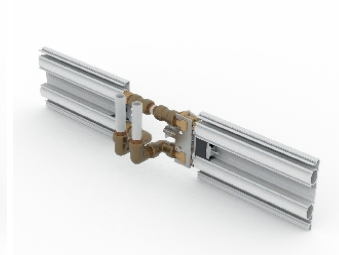

Pipes dropping from above
(Cavity wall)

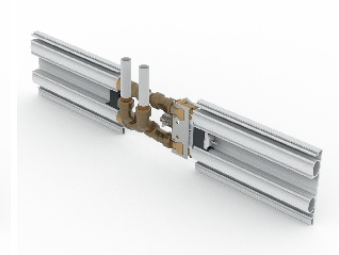

Pipes dropping from above
(Solid wall)

Alternative First fixes For anti-clockwise installation; mirror the connections

BM3 Clockwise Non TRV Templates.

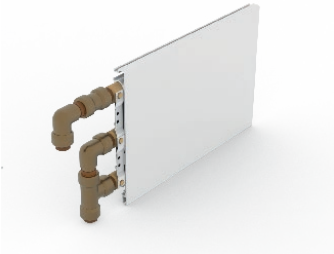

Pipes through floor



Pipes through wall

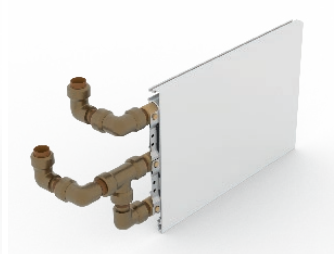

Pipes dropping from above
(Cavity wall)

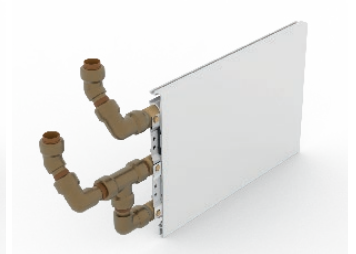

Pipes dropping from above
(Solid wall)

BM3 Clockwise TRV Templates.

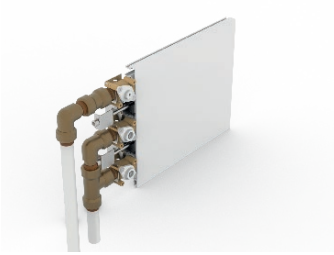

Pipes through floor

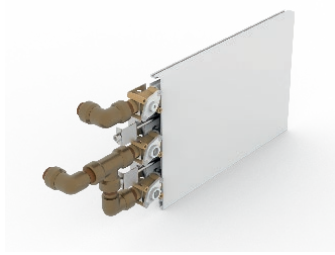

Pipes through wall

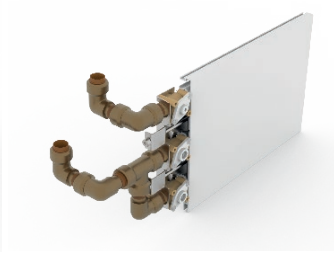

Pipes dropping from above
(Cavity wall)

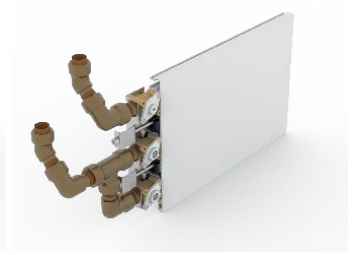

Pipes dropping from above
(Solid wall)

BM3 Bidirectional Non TRV Templates.

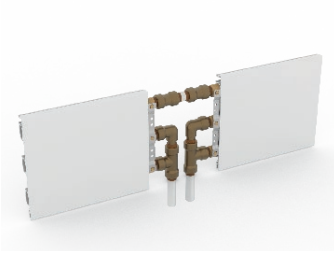

Pipes through floor

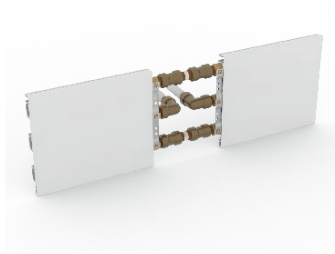

Pipes through wall

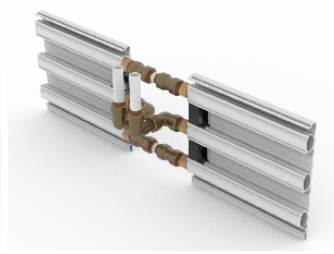

Pipes dropping from above
(Cavity wall)

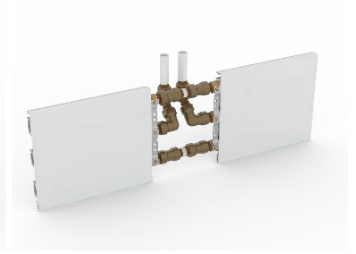

Pipes dropping from above
(Solid wall)

BM3 Bidirectional TRV Templates.

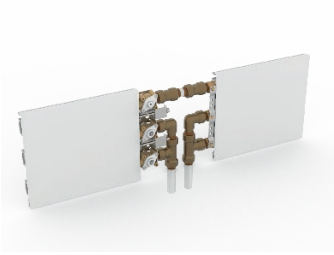

Pipes through floor

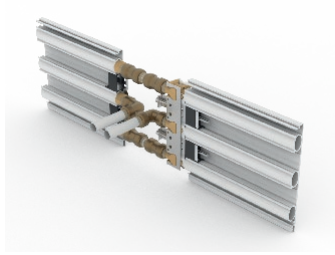

Pipes through wall

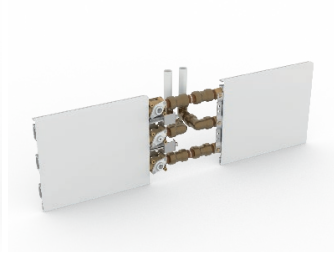

Pipes dropping from above
(Cavity wall)

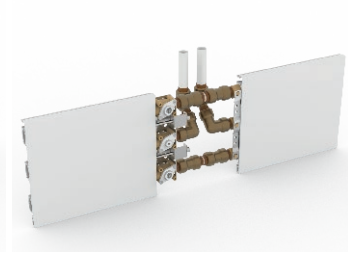

Pipes dropping from above
(Solid wall)



DiscreteHeat Company Limited

1 Victoria Works Industrial Estate,

Atherton, Manchester, M46 0FY.

www.discreteheat.com

01942 88 00 66

