

CX93GMBL

Cooker size	90x60 cm
N. of cavities with energy label	2
Cavity heat source	Electric
Hob type	Gas
Type of main oven	Thermo-ventilated
Type of second oven	Thermo-ventilated
EAN code	8017709334536
Energy efficiency class	A
Energy efficiency class, second cavity	B



Aesthetics



Aesthetics	Classic	Control knobs	Smeg Classic
Series	Concert	Controls colour	Stainless steel
Design	Standard	No. of controls	8
Colour	Black	Serigraphy colour	Silver
Finishing	Gloss Black	Display	Touch
Command panel finish	Enamelled metal	Door	Full glass
Logo	Silk screen	Glass type	Black
Logo position	Command panel	Handle	Smeg Classic
Hob colour	Black enamel	Handle Colour	Polished stainless steel
Type of pan stands	Cast Iron	Feet	Black
Type of control setting	Control knobs		

Programs / Functions

No. of cooking functions	1
Traditional cooking functions	



Circulaire

Programs / Functions Auxiliary Oven

Cooking functions cavity 2	1
----------------------------	---

Programme / Functions Third Oven

No. of functions third oven

1

Full grill



Hob technical features

UR

Total no. of cook zones 5

Front left - Gas - Rapid - 2.90 kW

Rear left - Gas - Semi Rapid - 1.80 kW

Central - Gas - UR - 4.00 kW

Rear right - Gas - Semi Rapid - 1.80 kW

Front right - Gas - AUX - 1.00 kW

Type of gas burners Standard

Gas safety valves

Yes

Automatic electronic ignition

Yes

Burner caps

Matte black enamelled

Main Oven Technical Features



No. of lights

1

Fan number

1

Net volume of the cavity

61 litres

Gross volume, 1st cavity

70 l

Cavity material

Easy clean enamel

Shelf positions

4

Type of shelves

Metal racks

Light type

Halogen

Light power

40 W

Cooking time setting

Start and Stop

Door opening

Side opening

Removable door

Yes

Full glass inner door

Yes

Removable inner door

Yes

Total no. of door glasses

3

No. of thermo-reflective door glasses

1

Safety Thermostat

Yes

Cooling system

Tangential

Usable cavity space dimensions (HxWxD)

316x460x412 mm

Temperature control

Electro-mechanical

Circular heating element - Power

2000 W

Options Main Oven

Timer

Yes

End of cooking acoustic alarm

Yes

Minimum Temperature

50 °C

Maximum temperature

245 °C

Second Oven Technical Features



Fan number	1	Full glass inner door	Yes
Net volume of the second cavity	62 litres	No. total door glasses	2
Gross volume, 2nd cavity	69 l	No. thermo-reflective door glasses	1
Cavity material	Easy clean enamel	Safety Thermostat	Yes
Shelf positions	9	Cooling system	Tangential
Type of shelves	Metal racks	Usable cavity space dimensions (HxWxD)	605x275x370 mm
Door opening	Side opening	Temperature control	Electro-mechanical
Removable door	Yes	Circular heating element - Power	2500 W

Options Auxiliary Oven

Minimum Temperature	50 °C	Maximum temperature	245 °C
----------------------------	-------	----------------------------	--------

Third Oven Technical Features



Net volume, 3rd cavity	35 l	No. total door glasses	3
Gross volume, 3rd cavity	41 l	No. of thermo-reflective door glasses	1
Cavity material	Easy clean enamel	Safety Thermostat	Yes
Shelf positions	2	Cooling system	Tangential
Type of shelves	Metal racks	Usable cavity space dimensions (HxWxD)	169x440x443 mm
Door opening	Flap down	Temperature control	Electro-mechanical
Removable door	Yes	Large grill - Power	2700 W
Full glass inner door	Yes	Grill type	Electric
Removable inner door	Yes	Tilting grill	Yes

Options Third Oven

Minimum Temperature	50 °C	Maximum temperature	260 °C
----------------------------	-------	----------------------------	--------

Accessories included for Main Oven & Hob

Chrome shelf with back and side stop	1	40mm deep tray	1
---	---	-----------------------	---

Accessories included for Secondary Oven

Chrome shelf with back stop	3
------------------------------------	---

Electrical Connection

Max Power Draw 7600 W
Current 33 A
Voltage 220-240 V
Voltage 2 (V) 380-415 V

Additional connection modalities Yes, Double and Three Phase
Frequency 50/60 Hz
Terminal block 5 poles

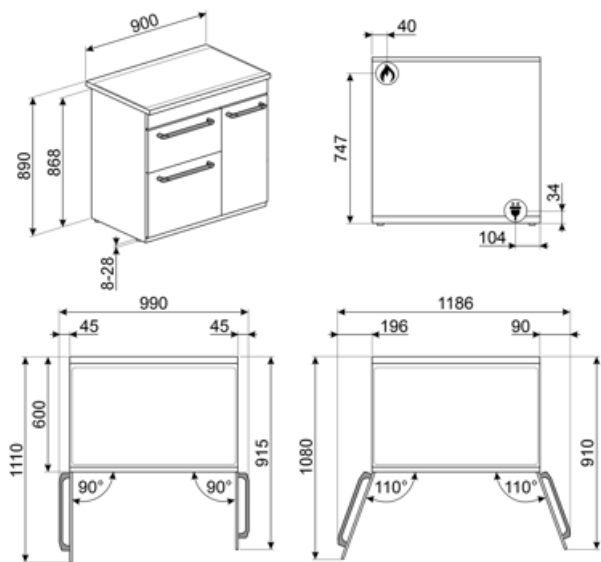

Compatible Accessories

AIRFRY

Air fryer rack AIRFRY . Ideal for recreating traditional frying in the oven, but with fewer calories and less fat. It allows you to cook quickly and simply dishes such as French fries, fried vegetables and fish, ensuring perfect browning and crispiness.



BG6090-1

Cast iron grill plate suitable for Concert cookers



BN640

Enamelled tray, 40mm deep



GRM

Gas hobs moka support



GTT

Totally extractable telescopic guides (1 level) Extraction: 433 mm Material: Stainless steel AISI 430 polished



KITH93

Height extension kit (950 mm), suitable for TR93 cookers



SFLK1

Child lock



STONE

Rectangular refractory stone. Ideal for cooking pizzas with the same results as a typical wood-fired oven. Can also be used for baking bread, focaccias and other recipes such as pies, flans or biscuits Dimensions:L42 x H1,8 x P37,5 cm.



BBQ

Double sided plate BBQ. Suitable for recreating succulent and crispy dishes in the oven with the typical taste of grilled cooking. The ribbed side is particularly suitable for meats and cheeses. The smooth side for fish, seafood and vegetables.



BN620-1

Enamelled tray, 20mm deep



BNP608T

Teflon-coated tray, 8mm depth, to be placed on the grid



GTP

Partially extractable telescopic guides (1 level) Extraction: 300 mm Material: Stainless steel AISI 430 polished



KIT90N9

Splashback 90 cm, black, for BU & BM cookers



PALPZ

Pizza shovel with fold away handle width: 315mm length : 325mm



SMOLD

Set of 7 silicone moulds for ice creams, ice lollies, pralines, ice cubes or to portion food. Usable from -60°C to +230°C

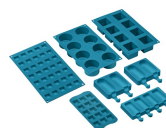

























WOKGHU

Cast-Iron WOK Support



Symbols glossary

	Heavy duty cast iron pan stands: for maximum stability and strength.		A: Product drying performance, measured from A+++ to D / G depending on the product family
	Installation in column: Installation in column		Air cooling system: to ensure a safe surface temperatures.
	B: Product energy rating, measured from A+++ to D / G depending on the product family.		Double glazed doors: Number of glazed doors.
	Triple glazed doors: Number of glazed doors.		Enamel interior: The enamel interior of all Smeg ovens have a special antacid lining which helps keep the interior clean by reducing the amount of cooking grease adhering to it.
	Circulaire: The combination of the fan and circular element around it gives a hot air cooking method. This provides many benefits including no preheat if cook time is more than 20 minutes, no flavour transfer when cooking different foods at the same time, less energy, and shorter cook times. Good for all types of food.		Grill element: Using of grill gives excellent results when cooking meat of medium and small portions, especially when combined with a rotisserie (where possible). Also ideal for cooking sausages and bacon.
	The touch timer display or DigiScreen guarantees simple functionality. They display the time, set programmed cooking and the minute minder timer.		Knobs control
	All glass inner door: All glass inner door, a single flat surface which is simple to keep clean.		The inner door glass: can be removed with a few quick movements for cleaning.
	Side lights: Two opposing side lights increase visibility inside the oven.		The oven cavity has 2 different cooking levels.
	The oven cavity has 4 different cooking levels.		The oven cavity has 9 different cooking levels.
	Electronic control: Allows you to maintain temperature inside the oven with the precision 2-3 ° C. This enables to cook meals that are very sensitive to temperature changes, such as cakes, souffles, puddings.		Tilting grill: the tilting grill can be easily unhooked to move the heating element and clean the roof of the appliance in one simple step.
	Ultra rapid burners: Powerful ultra rapid burners offer up to 5kw of power.		The capacity indicates the amount of usable space in the oven cavity in litres.
	The capacity indicates the amount of usable space in the oven cavity in litres.		The capacity indicates the amount of usable space in the oven cavity in litres.

Benefit

Circulaire

The best cooking performances guaranteed by ventilated circular flow.

Multiple fans and heating elements guarantee the perfect aerodynamic heat flow, allowing homogeneous and quicker cooking inside the cavity.

Gas hob

Gas provides constant control of the heat source, with an immediate change in temperature

Equipped with a thermocouple, the gas supply is cut off if the flame is extinguished for greater safety

Ever Clean Enamel

Easy oven cleaning thanks to the special antacid lining which helps to reduce the amount of dirt adhering to the surface.

Touch control

Easy and intuitive timer setting with a single touch

Single turbine

The oven has a fan equipped with a circular heating element allowing cooking with rotating heat

Isothermic Cavity

The best cooking performance at the highest energy efficiency

Tangential cooling

New cooling system with tangential fan and airflow from the door to the splashback

Multilevel halogen light

Internal halogen lighting on different levels guarantees excellent visibility

Adjustable height

Cooker top flushed with the working area thanks to adjustable feet

Removable inner glass

Internal door glasses are easily removable for complete cleaning

Multilevel cooking

Several cooking levels allow maximum flexibility of use

Cold door

During any function, the external door glass is cold, avoiding any risk of burns

AirFry (AIRFRY optional accessory)

Lighter and tastier food thanks to airfry basket

BBQ (optional accessory)

Barbeque cooking directly in the oven with the double-sided grill

Pizza stone (optional accessory)

Baking with refractory stone for soft and crispy pizza and yeast products (STONE optional accessory)