

OU5CP40B
OU5CP40M

EN User Manual | **Built-In Double Oven**



INSTALLATION

The diagram shows a 3D perspective view of an oven column with the following dimensions: top width 538mm, top depth 548mm, top offset 21mm, front panel height 114mm, main body height 872mm, side depth 594mm, and bottom offset 427mm. A side view shows a height of 875mm, a top width of 550mm, a top offset of 20mm, and a depth of 560-570mm. A detail shows a 2x3.5x25mm screw being used to secure the unit to a wall. A note indicates that two such screws are required (2x). A warning symbol is present in the detail. A YouTube link is provided for further instructions. A note specifies a minimum clearance of 1500mm for the H05 V V - F cable. The unit is marked with a circled 'i' and '2x'.

YouTube www.youtube.com/electrolux
www.youtube.com/aeg

How to install your AEG/Electrolux
Oven - Column installation

min. 1500

H05 V V - F

*[mm]

Welcome to AEG! Thank you for choosing our appliance.



Get usage advice, brochures, troubleshooting, service and repair information:
www.aeg.com/support

Subject to change without notice.

CONTENTS

1. SAFETY INFORMATION.....	3
2. SAFETY INSTRUCTIONS.....	5
3. PRODUCT DESCRIPTION.....	7
4. CONTROL PANEL.....	7
5. BEFORE FIRST USE.....	8
6. DAILY USE.....	9
7. ADDITIONAL FUNCTIONS.....	10
8. CLOCK FUNCTIONS.....	11
9. USING THE ACCESSORIES.....	12
10. HINTS AND TIPS.....	13
11. CARE AND CLEANING.....	15
12. TROUBLESHOOTING.....	17
13. ENERGY EFFICIENCY.....	18
14. ENVIRONMENTAL CONCERNS.....	19

1. ⚠ SAFETY INFORMATION

Before the installation and use of the appliance, carefully read the supplied instructions. The manufacturer is not responsible for any injuries or damage that are the result of incorrect installation or usage. Always keep the instructions in a safe and accessible location for future reference.

1.1 Children and vulnerable people safety

- This appliance can be used by children aged from 8 years and above and persons with reduced physical, sensory or mental capabilities or lack of experience and knowledge if they have been given supervision or instruction concerning the use of the appliance in a safe way and understand the hazards involved. Children of less than 8 years of age and persons with very extensive and complex disabilities shall be kept away from the appliance unless continuously supervised.

- Children should be supervised to ensure that they do not play with the appliance.
- Keep all packaging away from children and dispose of it appropriately.
- **WARNING:** The appliance and its accessible parts become hot during use. Keep children and pets away from the appliance when in use and when cooling down.
- If the appliance has a child safety device, it should be activated.
- Children shall not carry out cleaning and user maintenance of the appliance without supervision.

1.2 General Safety

- This appliance is for cooking purposes only.
- This appliance is designed for single household domestic use in an indoor environment.
- This appliance may be used in offices, hotel guest rooms, bed & breakfast guest rooms, farm guest houses, and other similar accommodation where such use does not exceed average domestic usage levels.
- Only a qualified person must install this appliance and replace the cable.
- Do not use the appliance before installing it in the built-in structure.
- Disconnect the appliance from the power supply before carrying out any maintenance.
- If the supply cord is damaged, it must be replaced by the manufacturer, its Authorised Service Centre or similarly qualified persons to avoid an electrical hazard.
- The means for disconnection must be incorporated in the fixed wiring in accordance with the wiring rules.
- **WARNING:** Ensure that the appliance is switched off before replacing the lamp to avoid the possibility of electric shock.
- **WARNING:** The appliance and its accessible parts become hot during use. Care should be taken to avoid touching heating elements or the surface of the appliance cavity.

- Always use oven gloves to remove or insert accessories or ovenware.
- To remove the shelf supports first pull the front of the shelf support and then the rear end away from the side walls. Install the shelf supports in the opposite sequence.
- Do not use a steam cleaner to clean the appliance.
- Do not use harsh abrasive cleaners or sharp metal scrapers to clean the glass door since they can scratch the surface, which may result in shattering of the glass.

2. SAFETY INSTRUCTIONS

2.1 Installation

WARNING!

Only a qualified person must install this appliance.

- Remove all the packaging.
- Do not install or use a damaged appliance.
- Follow the installation instructions available on our website.
- Always take care when moving the appliance as it is heavy. Always use safety gloves and enclosed footwear.
- Do not pull the appliance by the handle.
- Install the appliance in a safe and suitable place that meets installation requirements.
- Keep the minimum distance from other appliances and units.
- Before mounting the appliance, check if the appliance door opens without restraint.
- The appliance is equipped with an electric cooling system. It must be operated with the electric power supply.

2.2 Electrical connection

WARNING!

Risk of fire and electric shock.

- All electrical connections should be made by a qualified electrician.
- The appliance must be earthed.
- Make sure that the parameters on the rating plate are compatible with the

electrical ratings of the mains power supply.

- Always use a correctly installed shockproof socket.
- Do not use multi-plug adapters and extension cables.
- Make sure not to cause damage to the mains plug and to the mains cable. If the mains cable needs to be replaced, this must be carried out by our Authorised Service Centre.
- Do not let mains cables touch or come near the appliance door or the niche below, especially when it operates or the door is hot.
- The shock protection of live and insulated parts must be fastened in such a way that it cannot be removed without tools.
- Connect the mains plug to the mains socket only at the end of the installation. Make sure that there is access to the mains plug after the installation.
- If the mains socket is loose, do not connect the mains plug.
- Do not disconnect the appliance by pulling on the mains cable. Always pull on the mains plug.
- Use only correct isolation devices: line protecting cut-outs, fuses (screw type fuses removed from the holder), earth leakage trips and contactors.
- The electrical installation must have an isolation device which lets you disconnect the appliance from the mains at all poles. The isolation device must have a contact opening width of minimum 3 mm.

- This appliance is supplied without a main plug and a main cable.

2.3 Use

WARNING!

Risk of injury, burns and electric shock or explosion.

- Do not change the specification of this appliance.
- Make sure that the ventilation openings are not blocked.
- Do not let the appliance stay unattended during operation.
- Deactivate the appliance after each use.
- Be careful when you open the appliance door while the appliance is in operation. Hot air can be released.
- Do not operate the appliance with wet hands or when it comes in contact with water.
- Do not apply pressure on the open door.
- Do not use the appliance as a work surface or as a storage surface.
- Open the appliance door carefully. The use of ingredients with alcohol can cause a mixture of alcohol and air.
- Do not let sparks or open flames to come in contact with the appliance when you open the door.
- Always use glass and jars approved for preserving purposes.
- Do not put flammable products or items moistened with flammable products in, near or on the appliance.

WARNING!

Risk of damage to the appliance.

- To prevent damage or discolouration to the enamel:
 - do not put ovenware or other objects directly on the bottom of the appliance's cavity.
 - do not put aluminium foil directly on the bottom of cavity of the appliance.
 - do not put water directly into the hot appliance.
 - do not keep moist dishes and food in the appliance after you finish the cooking.

- be careful when you remove or install the accessories.

- Discolouration of the enamel or stainless steel has no effect on the performance of the appliance.
- Use a deep pan for moist cakes. Fruit juices cause stains that can be permanent.
- Use only accessories supplied with this appliance or recommended by the manufacturer.
- Always cook with the appliance door closed.
- If the appliance is installed behind a furniture panel (e.g. a door) make sure the door is never closed when the appliance operates. Heat and moisture can build up behind a closed furniture panel and cause subsequent damage to the appliance, the housing unit or the floor. Do not close the furniture panel until the appliance has cooled down completely after use.

2.4 Care and cleaning

WARNING!

Risk of injury, fire, or damage to the appliance.

- Before maintenance, deactivate the appliance and disconnect the mains plug from the mains socket.
- Make sure the appliance is cold. There is the risk that the glass panels can break.
- Replace immediately the door glass panels when they are damaged. Contact the Authorised Service Centre.
- Be careful when you remove the door from the appliance, the door is heavy.
- Clean regularly the appliance to prevent the deterioration of the surface material.
- Clean the appliance with a moist soft cloth. Use only neutral detergents. Do not use abrasive products, abrasive cleaning pads, solvents or metal objects.
- If you use an oven spray, follow the safety instructions on its packaging.
- Do not clean the catalytic enamel with detergents.

2.5 Internal lighting

⚠ WARNING!

Risk of electric shock.

- Concerning the lamp(s) inside this product and spare part lamps sold separately: These lamps are intended to withstand extreme physical conditions in household appliances, such as temperature, vibration, humidity, or are intended to signal information about the operational status of the appliance. They are not intended to be used in other applications and are not suitable for household room illumination.
- This product contains a light source of energy efficiency class G.
- Use only lamps with the same specifications.

2.6 Service

- To repair the appliance contact the Authorised Service Centre.
- Use original spare parts only.

2.7 Disposal

⚠ WARNING!

Risk of injury or suffocation.

- Contact your municipal authority for information on how to dispose of the appliance.
- Disconnect the appliance from the mains supply.
- Cut off the mains electrical cable close to the appliance and dispose of it.

3. PRODUCT DESCRIPTION

3.1 General overview

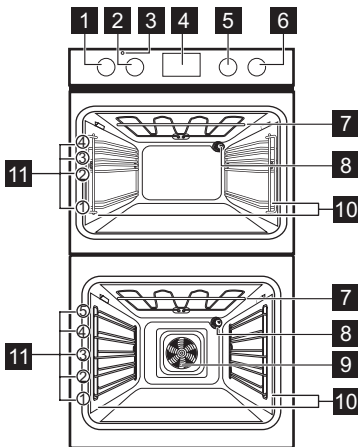

- Knob for the top oven functions
- Knob for the top oven temperature
- Temperature indicator / symbol for the top oven
- Display (for the main oven)
- Knob for the main oven functions
- Control knob for the main oven
- Heating element
- Lamp
- Fan
- Shelf support, removable
- Shelf positions

4. CONTROL PANEL

4.1 Turning the appliance on and off

To turn on the appliance:





- Press the knobs. The knobs come out (selected models only).

- Turn the knob for the heating functions to select a function.

- Turn the control knob to adjust settings.

To turn off the appliance: turn the knob for the heating functions to the off position.







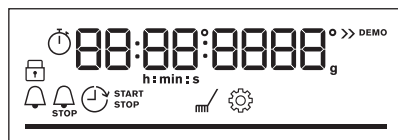

4.2 Control panel overview

Main oven sensor fields	
	Press to set timer functions.
	Press and hold to set the function: Fast Heat Up.
	Press to turn the appliance lamp on and off.
	Press and hold to set the function: Lock.
OK	Press to confirm your selection.

4.3 Display indicators

Display with key functions:



	The appliance is locked.
	Submenu: Cleaning.
	Submenu: Settings
	Fast Heat Up is activated.
	Minute minder is activated.
	Cooking time is activated.
	Time Delayed Start is activated.
	Uptimer is activated.
	Progress bar - visually indicates when the appliance reaches the set temperature or when the cooking time comes to an end.

5. BEFORE FIRST USE

WARNING!

Refer to Safety chapters.



5.1 Setting the time

After the first connection to the mains, wait until the display shows: "00:00" or "12:00" (depending on the model).

1. Turn the control knob to set the time.
2. Press OK.

5.2 Initial preheating and cleaning

Preheat both empty appliances before the first use and contact with food. Heat up one appliance at a time. The appliance can emit unpleasant smell and smoke. Ventilate the room during preheating. Set the functions listed below, if applicable.

1. Remove all accessories and removable shelf supports from the appliance.
2. Set the function . Set the temperature to 250°C. Refer to Daily use. Let the appliance operate for 1 h.
3. Set the function . Set the temperature to 250°C. Let the appliance operate for 15 min.
4. Set the function . Set the temperature to 250°C. Let the appliance operate for 15 min.
5. Turn off the appliance and wait until it is cold.
6. Clean the appliance and the accessories only with a microfibre cloth, warm water and a mild detergent.
7. Put the accessories and removable shelf supports back to their initial position.

6. DAILY USE

WARNING!

Refer to Safety chapters.

6.1 Main oven functions



True Fan Cooking

To roast meat and bake cakes on multi levels. Set a lower temperature than for Conventional Cooking as the fan distributes heat evenly in the oven interior.



Conventional Cooking

To bake and roast food on one shelf position. For the temperatures above 200°C, the cooking fan helps reach the set temperature faster.



Frozen Foods

To make convenience food crispy, e.g. french fries, potato wedges or spring rolls.



Pizza Function

To bake pizza and other dishes that require more heat from below. Use the lower shelf levels.



Bottom Heat

Choose this function after a cooking process to brown the food more on the bottom if needed. Use the lowest shelf level. Preheat the appliance for better results.



Defrost

To defrost food (vegetables and fruit). The defrosting time depends on the amount and size of the frozen food.



Moist Fan Baking

This function is designed to save energy during cooking. When you use this function, the temperature inside the appliance may differ from the set temperature. The residual heat is used. The heating power may be reduced. For more information refer to Daily use, Notes on: Moist Fan Baking.



Grill

To grill thin pieces of food and to toast bread.



Turbo Grilling

To roast large meat joints or poultry with bones on one shelf position. To bake gratins and to brown.



The lamp may turn off automatically at a temperature below 80°C during some oven functions.

6.2 Top oven functions



Light

To turn on the lamp.



Conventional Cooking / Cleaning

To bake and roast food on one shelf position. Refer to Care and cleaning chapter for more information about Catalytic cleaning.



Top Heat

To brown bread, cakes and pastries. To finish cooked dishes.



Bottom Heat

To make browning and crispy bottom. Use the lowest shelf position.



Grill

To grill thin pieces of food and to toast bread.



Fast Grilling

To grill thin pieces of food in large quantities and to toast bread.

6.3 Notes on: Moist Fan Baking

This function was used to comply with the energy efficiency class and ecodesign requirements (according to EU 65/2014 and EU 66/2014). Tests according to: IEC/EN 60350-1.

The oven door should be closed during cooking so that the function is not interrupted and the oven operates with the highest energy efficiency possible.

When you use this function the lamp automatically turns off.

For the cooking instructions refer to Hints and tips, Moist Fan Baking. For general energy saving recommendations refer to Energy efficiency, Energy saving tips.

6.4 Setting: Heating functions

1. Turn the knob for the heating functions to select a heating function.
2. Turn the control knob to set the temperature.
3. Press **OK**.

» Fast Heat Up - press and hold to shorten the heating time. It is available for some heating functions. Fan may turn on automatically.

6.5 Entering: Menu



Open the Menu to access Assisted Cooking dishes and settings.

1. Turn the knob for the heating functions to .

The display shows  / .

2. Turn the control knob and select the icon to enter submenu. Press **OK**.

6.6 Changing: Settings

1. Turn the knob for the heating functions to .
2. Turn the control knob to select . Press **OK**.

3. Turn the control knob to select the setting. Press **OK**.
4. Turn the control knob to adjust the value. Press **OK**.
5. Turn the knob for the heating functions to the off position to exit Menu.

Submenu: Settings

Setting	Value
01 Time of day	Change
02 Display brightness	1 - 5
03 Key tones	1 - Beep, 2 - Click, 3 - Sound off
04 Buzzer volume	1 - 4
05 Uptimer	On / Off
06 Light	On / Off
07 Fast Heat Up	On / Off
08 Software version	Check
09 Reset all settings	Yes / No

7. ADDITIONAL FUNCTIONS

7.1 Lock

This function prevents an accidental change of the appliance function. It works only for the main oven.

When activated while the appliance is in use, it locks the control panel, ensuring that the current cooking settings continue uninterrupted.

When activated while the appliance is off, it keeps the control panel locked, preventing the appliance from being turned on unintentionally.



 - press and hold to turn on the function.

A signal sounds.  - flashes 3 times when the lock is turned on.

 - press and hold to turn off the function.

7.2 Automatic switch-off

The function works only for the main oven. For safety reasons, if the heating function is active and no settings are changed, the appliance will turn off automatically after a certain period of time.

 (°C)	 (h)
30 - 115	12.5
120 - 195	8.5
200 - 245	5.5
250 - maximum	3

If you intend to run a heating function for a duration exceeding the automatic switch-off

time, set the cooking time. Refer to Clock functions.

The Automatic switch-off does not work with the functions: Light, Time Delayed Start.





7.3 Cooling fan

When the appliance operates, the cooling fan turns on automatically to keep the surfaces of

the appliance cool. If you turn off the appliance, the cooling fan can continue to operate until the appliance cools down.

8. CLOCK FUNCTIONS

8.1 Timer functions description

 Minute minder	To set a countdown timer. When the timer ends, the signal sounds. This function has no effect on the operation of the appliance and can be set at any time.
 Cooking time	To set cooking duration. When the timer ends, the signal sounds and the heating function will automatically turn off. The function works only for the main oven.
 Time Delayed Start	To postpone the start and / or end of cooking. The function works only for the main oven.
 Uptimer	To show how long the appliance operates. Maximum is 23 h 59 min. This function has no effect on the operation of the appliance and can be set at any time.



8.2 Setting: Minute minder

1. Press .

The display shows: 0:00 and .



2. Turn the control knob to set the Minute minder.
3. Press **OK**. The timer starts counting down immediately.

8.3 Setting: Cooking time

1. Turn the knobs to select the heating function and to set the temperature.
2. Press  until the display shows: 0:00 and .
3. Turn the control knob to set the Cooking time.

4. Press **OK**. The timer starts counting down immediately.
5. When the time ends, press **OK** and turn the knob for the heating functions to the off position.



8.4 Setting: Time Delayed Start

1. Turn the knobs to select the heating function and to set the temperature.
2. Press  until the display shows:  and **START**.
3. Turn the control knob to set the start time.
4. Press **OK**.



The display shows: --:--  **STOP**.

5. Turn the control knob to set the end time.
6. Press **OK**.
The timer starts counting down at a set start time.
7. When the time ends, press **OK** and turn the knob for the heating functions to the off position.

8.5 Setting: Uptimer

1. Turn the knob for the heating functions to  to enter Menu.
2. Turn the control knob to select  / Uptimer. Refer to Daily use, Menu: Settings.
3. Press **OK**.
4. Turn the control knob to turn the Uptimer on and off.
5. Press **OK**.

8.6 Setting: Time of day

1. Turn the knob for the heating functions to  to enter Menu.
2. Turn the control knob to select  / Time of day. Refer to Daily use, Menu: Settings.

3. Turn the control knob to set the clock.
4. Press **OK**.

9. USING THE ACCESSORIES

WARNING!

Refer to Safety chapters.

9.1 Inserting accessories

Accessories available depending on model. Scan the QR code to check how to use accessories supplied with your appliance. You can order optional accessories separately. For more information, please contact your local supplier.



A small indentation at the top increases safety and provides tilt protection. The indentations are also anti-tip devices. The rim around the shelf prevents cookware from slipping off the shelf.

Insert the accessory (wire shelf / tray) between the guide bars of the shelf support. Make sure that the shelf touches the back of the oven interior.

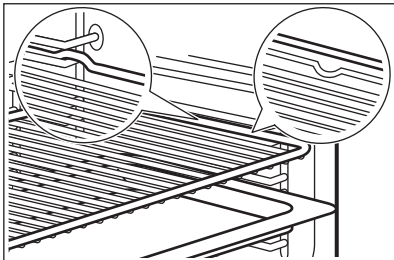

If your tray has a slope, position it towards the back of the oven interior.

If there is an inscription on the accessory, make sure it is facing you.

If you are using a tray with holes place the tray / pan underneath, to collect dripping liquids.

9.2 Trivet and Grill- / Roasting pan

WARNING!

Be careful when you remove the accessories from a hot appliance. There is a risk of burns.

You can use the trivet to roast larger pieces of meat or poultry on one shelf position.

1. Put the trivet into the deep pan so that the supports of the wire shelf point up.

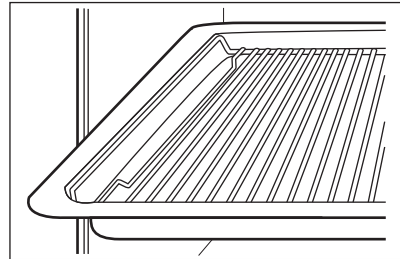

2. Put the deep pan into the appliance on the necessary shelf position.

You can use the trivet to grill flat dishes in large quantities and to toast.

1. Put the trivet into the deep pan so that the supports of the wire shelf point down.

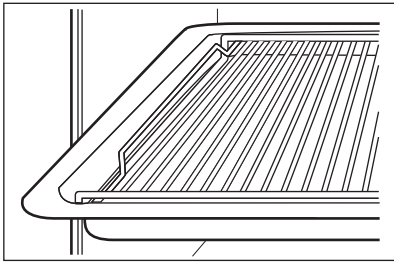

- Put the deep pan into the appliance on the necessary shelf position.

10. HINTS AND TIPS

10.1 Cooking recommendations

The temperature and cooking times in the tables are for guidance only. They depend on the recipes, quality and quantity of the ingredients used.

Your appliance may bake or roast differently than your previous appliance. The hints below show recommended settings for temperature, cooking time and shelf position for specific types of food.

Count the shelf positions from the bottom of the oven floor.

If you cannot find the settings for a specific recipe, look for a similar one.

For energy saving tips refer to Energy efficiency.

Symbols used in the tables:

	Food type
	Heating function
°C	Temperature

	Accessory
	Shelf position
	Cooking time (min)

10.2 Moist Fan Baking - recommended accessories





Use dark and non-reflective tins and containers. They have better heat absorption than light colour and reflective dishes.

- **Pizza pan** - dark, non-reflective, diameter 28 cm
- **Baking dish** - dark, non-reflective, diameter 26 cm
- **Ramekins** - ceramic, diameter 8 cm, height 5 cm
- **Flan base tin** - dark, non-reflective, diameter 28 cm

10.3 Moist Fan Baking

For the best results follow suggestions listed in the table below.





		°C		
Sweet rolls, 16 pieces	baking tray or dripping pan	180	3	35 - 45
Swiss Roll	baking tray or dripping pan	180	2	30 - 40
Brownie	baking tray or dripping pan	180	2	30 - 40
Sponge flan base	flan base tin on wire shelf	180	2	30 - 40
Victoria sandwich	baking dish on wire shelf	170	2	40 - 50

		°C		
Poached fish, 0.3 kg	baking tray or dripping pan	180	3	20 - 30
Whole fish, 0.2 kg	baking tray or dripping pan	180	3	20 - 30
Poached meat, 0.25 kg	baking tray or dripping pan	200	3	30 - 40
Cookies, 16 pieces	baking tray or dripping pan	170	2	25 - 35
Macaroons, 24 pieces	baking tray or dripping pan	160	2	35 - 45
Muffins, 12 pieces	baking tray or dripping pan	170	2	25 - 35
Savory pastry, 20 pieces	baking tray or dripping pan	170	3	30 - 40
Short crust biscuits, 20 pieces	baking tray or dripping pan	150	3	30 - 40
Tartlets, 8 pieces	baking tray or dripping pan	180	2	25 - 35
Vegetables, poached, 0.4 kg	baking tray or dripping pan	180	3	30 - 40
Vegetarian omelette	pizza pan on wire shelf	200	3	35 - 45

10.4 Information for test institutes

Tests according to: EN 60350-1, IEC 60350-1

Main oven - baking on one level

				°C	
Small cakes, 20 per tray ¹⁾	Conventional Cooking	Baking tray ²⁾	3	160	20 - 30
Small cakes, 20 per tray ¹⁾	True Fan Cooking	Baking tray ²⁾	3	145	25 - 30
Shortbread, 6 stripes per tray ¹⁾	Conventional Cooking	Wire shelf ³⁾	3	140	25 - 35
Shortbread, 6 stripes per tray ¹⁾	True Fan Cooking	Wire shelf ³⁾	3	140	25 - 35
Fatless sponge cake, Ø of tin: 26 cm) ¹⁾	Conventional Cooking	Wire shelf	2	170	25 - 35
Fatless sponge cake, Ø of tin: 26 cm) ¹⁾	True Fan Cooking	Wire shelf	2	170	25 - 35
Toast ¹⁾⁴⁾	Grill	Wire shelf	4	300	2 - 3





¹⁾ Preheat the appliance until set temperature is reached. Do not use the function: Fast Heat Up.

²⁾ Baking tray should not touch the back of the oven interior.

³⁾ Place small baking tray on wire shelf.

⁴⁾ According to: IEC 60350-1:2016 and IEC 60350-1:2023.





Main oven - baking on two levels

				°C	
Shortbread, 6 stripes per tray 1)	True Fan Cooking	AirFry oven basket and Wire shelf 2)	2 and 4	140	25 - 35
Fatless sponge cake, Ø of tins: 26 cm) 1)	True Fan Cooking	AirFry oven basket and Wire shelf	2 and 4	180	35 - 45

1) Preheat the appliance until set temperature is reached. Do not use the function: Fast Heat Up.

2) Place small baking tray on wire shelf.





Main oven - additional recipes

				°C	
Chicken 1)	Turbo Grilling	Trivet positioned in deep pan	3	200	60 - 70
Pizza, frozen 2)	Conventional Cooking	Wire shelf	2	230	10 - 20

1) Place chicken with breast side down. Turn it upside down halfway through the cooking time.

2) Preheat the appliance until set temperature is reached. Do not use the function: Fast Heat Up.

Top oven

				°C	
Toast 1)	Fast Grilling	Wire shelf	2	275	3 - 4

1) Preheat the appliance until set temperature is reached. Do not use the function: Fast Heat Up.

11. CARE AND CLEANING

WARNING!

Refer to Safety chapters.

11.1 Notes on cleaning

Cleaning agents

- Clean the front of the appliance only with a microfibre cloth with warm water and a mild detergent.
- Use a cleaning solution to clean metal surfaces.
- Clean stains with a mild detergent. Do not apply it on the catalytic surfaces.

Everyday use

- Clean the interior of the appliance after each use. Fat accumulation or other residue may cause fire.

- Do not store food in the appliance for longer than 20 minutes. Dry the interior of the appliance only with a microfibre cloth after each use.

Accessories

- Clean all accessories after each use and let them dry. Use only a microfibre cloth with warm water and a mild detergent. Do not clean the accessories in a dishwasher.
- Do not clean the non-stick accessories using abrasive cleaner or sharp-edged objects.

11.2 Removing the shelf supports

Remove the shelf supports to clean the appliance.

1. Turn off the appliance and wait until it is cold.

2. Pull the front of the shelf support away from the side wall.
3. Pull the rear end of the shelf support away from the side wall and remove it.

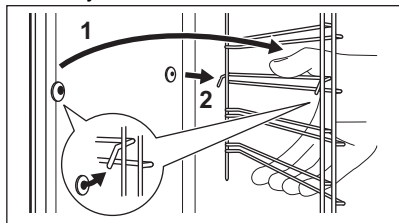

4. Put the shelf supports back to the initial position. Repeat the steps in the reverse order.

If the telescopic runners are supplied, its retaining pins must point to the front.

11.3 Catalytic cleaning

The cavity is coated with catalytic enamel. It absorbs fat during catalysis. The catalytic enamel is self cleaning, do not clean it with a cloth.



Spots or discolouration of the catalytic coating have no effect on the cleaning.

Clean one oven at a time.

Before the catalytic cleaning:

- Turn off the appliance and wait until it is cold.
- Remove all accessories and removable shelf supports.
- Clean only the oven floor and the inner door glass with warm water, soft cloth and mild detergent.

Cleaning the main oven with catalytic cleaning

1. Select Menu  / Cleaning 
2. Press OK.
The duration of the cleaning is fixed (1 h).
When the cleaning ends the signal sounds.
The oven turns off.
3. When the oven is cold, clean the oven floor with a wet soft cloth.

Cleaning the top oven with catalytic cleaning

1. Set the function: .
2. Set the maximum oven temperature.
The duration of the cleaning is fixed (1 h).
3. After cleaning, turn the knob for the heating functions to the off position.
4. When the oven is cold, clean the oven floor with a wet soft cloth

11.4 Removing and installing door

You can remove the door and the internal glass panels to clean it. The number of glass panels is different for different models.

WARNING!

The door is heavy.

CAUTION!

Carefully handle the glass, especially around the edges of the front panel. The glass can break.

1. Make sure the appliance is cold.
2. Fully open the door.
3. Lift and press the clamping levers **A** on the two door hinges.

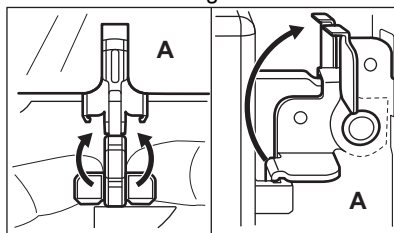

4. Close the oven door to the first opening position (at approximate angle: 45°).
5. Hold the door with one hand on each side and pull it away from the oven at an upwards angle.
6. Put the door with the outer side down on a soft cloth on a stable surface.
7. Hold the door trim **B** on the top edge of the door at the two sides and push inwards to release the clip seal.

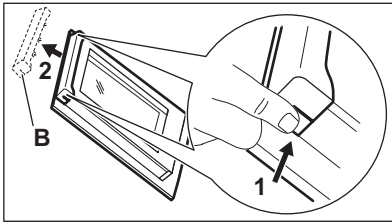

8. Pull the door trim to the front to remove it.
9. Hold the door glass panels on their top edge one by one and pull them up out of the guide.

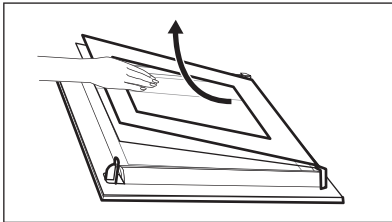

10. Clean the glass panel with water and soap. Dry the glass panel carefully. Do not clean the glass panels in the dishwasher.

After cleaning, do the above steps in the opposite sequence. Install the smaller panel first, then the larger and the door.

Make sure that the glass panels are inserted in the correct position otherwise the surface of the door may overheat.

11.5 Replacing the lamp

WARNING!

Risk of electric shock.
The lamp can be hot.

1. Turn off the appliance and wait until it is cold.
2. Disconnect the appliance from the mains.
3. Place the cloth on the oven floor.

Back lamp

1. Turn the glass cover to remove it.
2. Clean the glass cover.
3. Replace the lamp with a suitable 300°C heat-resistant lamp.
4. Install the glass cover.

12. TROUBLESHOOTING

WARNING!

Refer to Safety chapters.

12.1 What to do if...

Problem	Check if...
You cannot activate or operate the appliance.	The appliance is correctly connected to an electrical supply.
The appliance does not heat up.	The automatic switch-off is deactivated.
The appliance does not heat up.	The fuse is not blown.
The appliance does not heat up.	Lock is deactivated.
The lamp is turned off.	Moist Fan Baking - is activated.
The lamp does not work.	The lamp is burnt out.
The display shows 00:00.	There was a power cut. Set the time of day.



If the display shows an error code that is not in this table, turn the house fuse off and on to restart the appliance. If the error code recurs contact an Authorised Service Centre.

12.2 Service data

If you cannot find a solution to the problem yourself, contact your dealer or an Authorised Service Centre.

The necessary data for the service centre is on the rating plate. The rating plate is located on the front frame of the appliance. It is visible when you open the door. Do not remove the rating plate from the appliance.

We recommend that you write the data here:

Model (MOD.):

Product number (PNC):

Serial number (S.N.):

13. ENERGY EFFICIENCY

13.1 Product Information Sheet and Product Information according to EU and UK Energy Labelling and Ecodesign Regulations

Supplier's name	AEG	
Model identification	OU5CP40B 944171788 OU5CP40M 944171789	
Energy Efficiency Index	Top oven: 106.8 Main oven: 95.1	
Energy efficiency class	Top oven: A Main oven: A	
Energy consumption with a standard load, conventional mode	Top oven: 0.78 kWh/cycle Main oven: 0.92 kWh/cycle	
Energy consumption with a standard load, fan-forced mode	Top oven: - Main oven: 0.77 kWh/cycle	
Number of cavities	2	
Heat source	Electricity	
Volume	Top oven: 42 l Main oven: 61 l	
Type of oven	Built-In Oven	
Mass	OU5CP40B	51.6 kg
	OU5CP40M	49.5 kg

IEC/EN 60350-1 - Household electric cooking appliances - Part 1: Ranges, ovens, steam ovens and grills - Methods for measuring performance.

13.2 Product information for power consumption and maximum time to reach applicable low power mode

Power consumption in standby	0.8 W
Maximum time needed for the equipment to automatically reach the applicable low power mode	20 min

13.3 Energy saving tips

Following tips below will help you save energy when using your appliance.

Make sure that the appliance door is closed when the appliance operates. Do not open the appliance door too often during cooking. Keep the door gasket clean and make sure it is well fixed in its position.

Use metal cookware and dark, non-reflective tins and containers to improve energy saving.

Do not preheat the appliance before cooking unless specifically recommended.

Keep breaks between baking as short as possible when you prepare a few dishes at one time.

Cooking with fan

When possible, use the cooking functions with fan to save energy.

Residual heat

When the cooking duration is longer than 30 min, reduce the appliance temperature to

minimum 3 - 10 min before the end of cooking. The residual heat inside the appliance will continue to cook.

Use the residual heat to keep the food warm or warm up other dishes.

When you turn off the appliance, the display shows the residual heat or temperature.

Keep food warm

Choose the lowest possible temperature setting to use residual heat and keep the food warm. The residual heat indicator or temperature appears on the display.

Cooking with the lamp off

Turn off the lamp during cooking. Turn it on only when you need it.

Moist Fan Baking

Function designed to save energy during cooking.

When you use this function the lamp is off.

14. ENVIRONMENTAL CONCERNS

Recycle materials with the symbol . Put the packaging in relevant containers to recycle it. Help protect the environment and human health by recycling waste of electrical and electronic appliances. Do not dispose of

appliances marked with the symbol  with the household waste. Return the product to your local recycling facility or contact your municipal office.

aeg.com

867387826-A-422025



UK
CA CE