

Drayton Digistat+ & Digistat+RF

by Schneider Electric

Room Thermostat

Models:
30002 / RF601



Installation Guide

Technical Data DIGISTAT+, DIGISTAT+RF ROOM UNIT

Power Supply:	2 x AA Size, 1.5V alkaline batteries
Switch Type & Rating:	SPDT 2(1)A 12-240V ac(dc) Volt free
Relay version:	SPDT 2(1)A 12-240V ac(dc) Volt free
Radio frequency:	433 MHz
RF version:	433 MHz
Radio Signal Range: (RF Version)	30m typically. The range may be affected by the composition / density and number of walls between the Digistat RF and SCR.
Temperature Range:	5 to 30°C
Control Accuracy:	+ 0.5K @ 20°C
Ambient Temperature:	Operating 0°C to 50°C / Storage -20°C to 55°C
Mounting:	Suitable for surface or conduit box mounting
Wiring: Relay:	Designed for fixed wiring only, to comply with current IEE regulations.
RF:	No wiring required
Pollution Degree:	2
Energy Class: (ErP Rating)	IV=2% (According to EU: 811/2013, 812/2013, 813/2013 & 814/2014)
Software Class:	A
Software version:	6712057
Maximum Radiated Power:	+7.5dBm (5.6mW)

SINGLE CHANNEL RECEIVER (SCR)	
Power Supply:	230V ac 50Hz
Switch Type & Rating:	SPDT (voltage free) 2(1)A 230V ac or 23V ac (dc)
Wiring:	Designed for fixed wiring only, to comply with current IEE regulations.
Reception Frequency:	433 MHz
Mounting:	Industry Standard Wallplate
Pollution Degree:	2
Software Class:	A
Rated Impulse Voltage:	2.5Kv
Ball Pressure Test:	75°C

Relevant EC Directives:	2014/53/EU RED Directive 2011/65/EU RoHS Directive 2006/66/EU Battery Directive
Applied Standards:	EN60730-1; EN60730-2-9 EN 300 220-2; EN 301 489-3

Location

Room Thermostat

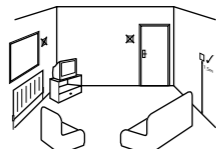

Care should be taken to mount the thermostat in a position which is not subject to direct sunlight or draughts. Preferably it should be mounted on an inside wall about 1.5m (5ft) above the floor in a position where it can respond to room temperature but away from the direct influence of radiators or other appliances giving off heat.

Signal Strength

Before fixing the Digistat+RF to the wall it is recommended to first check the signal strength from that location.

To do this, remove the batteries, press and hold the 'set' button whilst refitting the batteries, keep the 'set' button held and after a few seconds the display will show 'rF' which indicates that the Digistat+RF is continuously sending an OFF signal to the SCR (receiver). Leave the Digistat+RF in position and return to view the SCR. If the red LED is continuously flashing, this indicates a good signal. If the red LED is not flashing, this indicates a poor signal and you need to reposition the Digistat+RF until the red LED is flashing.

When the signal strength has been confirmed remove the batteries to cancel the test and follow the installation instructions.

Before Installation

If you do not have the knowledge to install the thermostat safely then you must arrange for a competent electrician to install it for you. Wiring must conform to the current IEE regulations.

Prior to commencing the installation you must ensure the mains supply is switched off.

Remove battery compartment



Loosen screw

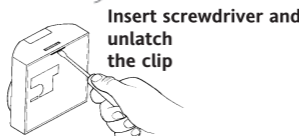

Insert screwdriver and unlatch the clip

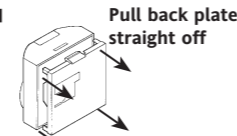

Pull back plate straight off

Standard cable entry is from the rear, but if surface wiring, from the top or bottom, is to be used, or extra space for cabling is required, use the optional Pattress box (sold separately).

WIRING

Room Thermostat (not RF models)

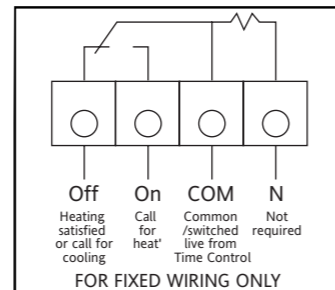

When changing an existing product and there is a neutral wire present, use the neutral (N) terminal on the product.

INSTALLER OPTIONS

The following installer options can be adjusted.

1. Application Type
2. System Capability

To enter the 'Installer' menu, press and hold the 'Set' button for more than 10 seconds – the display will show 'In' (Installer menu) as shown,

Application Type

• Rotate the dial clockwise until 'ty' (Application Type) is shown,

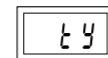

• Then press the 'Set' button, the current setting is shown,

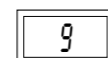

g = Gas Boiler
o = Oil Boiler

• Rotate the dial until the required Application Type is shown, then press 'Set' to confirm.

System Capability

Adjust this setting to suit the heating system capability.

• Rotate the dial until 'Sy' (System Capability) is shown

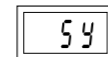

• Then press the 'Set' button, the current setting is shown,

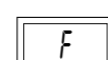

F = Fast – the house usually reaches setpoint in <1hour
S = Slow – the house usually reaches setpoint in >1hour

• Rotate the dial until the required System Capability is shown, then press 'Set' to confirm.

To return to normal operation, either press the 'Set' button for more than 5 seconds or wait for 1 minute and it will return automatically

Tear here

Drayton Digistat+ & Digistat+RF

by Schneider Electric

Room Thermostat

Models:
30002 / RF601



Technical Helpline Tel: 0333 7000 622

Website: www.draytoncontrols.co.uk

Email: customer.care@draytoncontrols.co.uk

06490056001 Iss L

Drayton

401 Southway Drive
Plymouth
PL6 6QT
United Kingdom

Drayton Controls reserve the right to make changes without notice and cannot accept liability for errors.

Hereby, Schneider Electric Controls UK LTD, declares that this Room Thermostat is in compliance with the essential requirements and other relevant provisions of RED-DIRECTIVE 2014/53/EU. Declaration of conformity can be downloaded on: www.draytoncontrols.co.uk

User Guide



What is a room thermostat?

... An explanation for householders

A room thermostat simply switches the heating system on and off as necessary. It works by sensing the air temperature, switching on the heating when the air temperature falls below the thermostat setting, and switching it off once this set temperature has been reached.

Turning a room thermostat to a higher setting will not make the room heat up any faster. How quickly the room heats up depends on the design of the heating system, for example, the size of boiler and radiators.

Neither does the setting affect how quickly the room cools down. Turning a room thermostat to a lower setting will result in the room being controlled at a lower temperature, and saves energy.

The heating system will not work if a time switch or programmer has switched it off.

The way to set and use your room thermostat is to find the lowest temperature setting that you are comfortable with, and then leave it alone to do its job. The best way to do this is to set the room thermostat to a low temperature – say 18°C – and then turn it up by one degree each day until you are comfortable with the temperature. You won't have to adjust the thermostat further. Any adjustment above this setting will waste energy and cost you more money.

If your heating system is a boiler with radiators, there will usually be only one room thermostat to control the whole house. But you can have different temperatures in individual rooms by installing thermostatic radiator valves (TRVs) on individual radiators. If you don't have TRVs, you should choose a temperature that is reasonable for the whole house. If you do have TRVs, you can choose a slightly higher setting to make sure that even the coldest room is comfortable, then prevent any overheating in other rooms by adjusting the TRVs.

Room thermostats need a free flow of air to sense the temperature, so they must not be covered by curtains or blocked by furniture. Nearby electric fires, televisions, wall or table lamps may prevent the thermostat from working properly.

Your new thermostat with digital display.

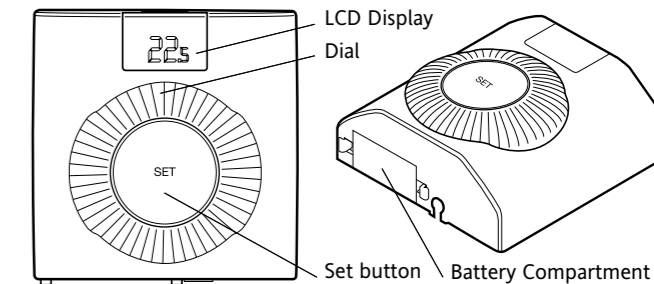

Thermostat Display – Features & Characters

An RF Model is shown by an antenna symbol on the display. (No symbol denotes a wired model).

A demand for heat is shown by a flame symbol on the display, i.e. the thermostat is calling for heat to bring the room up to or maintain it at the desired temperature.

During normal operation the display shows the actual room temperature.

When the desired temperature is being adjusted the word 'SET' is shown on the display.

Low battery warning is shown by a flashing battery symbol on the display.

FEATURES

This product has the following user adjustable settings

- Required room temperature (temperature setpoint)
- Preset temperature setting - Advanced feature
- Minimum & Maximum temperature settings - Advanced feature

Simple Setting or Operating

To set the required room temperature

- The display normally shows the current room temperature to within 0.5°C
- To adjust the required temperature, turn the dial clockwise to increase or anti-clockwise to decrease, (1 click = 1°C), the LCD will display the temperature setpoint as it is being adjusted and 'SET' will be displayed. After a few seconds the display will return to normal operation and will display the actual room temperature.

While adjusting the temperature during normal operation, when you reach the maximum or minimum possible setting the display will flash to indicate you cannot adjust the product further.

ADVANCED FEATURES

Adjusting the Setpoint using the Preset Temperature Mode

Change the temperature at the press of a button, for example, if you are going out to the shops for an hour you can reduce the temperature to save energy and then when you press the button again on your return the setpoint will return to the previous level.

- To adjust the setpoint to the preset (or Setback) temperature, press the 'Set' button during normal operation and the product will go into Preset mode.

NB. This feature can be used to quickly adjust the temperature setpoint to a setback temperature for economy operation if for example, 'Preset Temperature = 15°C'. Or alternatively to a comfort setpoint if 'Preset Temperature = 21°C'.

- Once the setpoint has been changed to the preset (or setback) temperature by pressing 'Set' the display will show the 'Preset Temperature' and 'SET' will be flashing in the display as shown,



'SET' will flash for approximately 5 seconds and during this time the 'Preset Temperature' can be altered by rotating the dial.

- The product will remain in the Preset mode. Once 5 seconds have elapsed (since the last dial adjustment) the word 'SET' will stop flashing on the display as shown,



The product is still in the Preset mode.

Tear here

To cancel the Preset Mode & return to normal operation

You can either,

1. If you want to return to your previous setpoint (before you entered the Preset mode) then press the 'SET' button. The Preset mode will be cancelled and the product will return to normal operation and the display will show the current room temperature as shown,

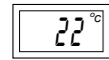

2. If you want to set a new setpoint, just rotate the dial until your required setpoint is shown on the display. After a couple of seconds the display will change to show the current room temperature as shown,

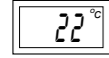

To change the user adjustable settings

- To enter the 'User' menu, press and hold the 'Set' button for more than 5 but less than 10 seconds – the display will show 'Pr' (Preset temperature setting) as shown,



- If the dial is turned clockwise one click then 'HI' (Maximum temperature setting) will be displayed and if turned one more click clockwise then 'Lo' (Minimum temperature setting) will be displayed.

Changing the Preset Temperature

- To adjust the 'Preset' temperature enter the user menu as described above, then rotate the dial until 'Pr' is shown, press the set button and the display will show the current Preset setting.



- Rotate the dial clockwise to increase the Preset temperature & anti-clockwise to reduce the Preset temperature. Press the 'Set' button to confirm and 'Pr' will be displayed.



Changing the Maximum Temperature Setting

- To adjust the maximum temperature setting enter the user menu as described above, then rotate the dial clockwise until 'HI' is showing.



- Then press the 'Set' button, the current setting is shown.



- Rotate the dial clockwise to increase the maximum temperature setting (max.30°C) and anti-clockwise to reduce the maximum temperature setting (min 5°C or min. temp. setting). Press the 'Set' button to confirm, the display will show,



Changing the Minimum Temperature Setting

- To adjust the minimum temperature setting enter the user menu as described above, then rotate the dial clockwise until 'Lo' is showing.



- Then press the 'Set' button, the current setting is shown.



- Rotate the dial clockwise to increase the minimum temperature setting (max.30°C or max. temp. setting) and anti-clockwise to reduce the minimum temperature setting (min 5°C). Press the 'Set' button to confirm, the display will show,



While adjusting the settings within the menu, when you reach the maximum or minimum possible setting the display will flash to indicate you cannot adjust the product further, e.g. you cannot set the Preset higher than the maximum temperature setting.

To return to normal operation, either press the 'Set' button for more than 5sec or wait for 1 minute and it will return automatically.

TAMPER PROOFING (All Models)

To tamper proof the product i.e. prevent unauthorised adjustment of the product set the Min and Max temperatures to the same desired value.

FAULT DIAGNOSIS (All Models)

If the display shows E1, the following faults could have occurred

1. Internal temperature sensor has failed.
2. Ambient temperature is outside product operating temperature range.

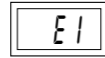

BATTERY REPLACEMENT (All Models)

- When the batteries are getting low (approx 30 days battery life remaining) the battery symbol will flash in the display, it is recommended to change the batteries during this period.
- After approx 30 days, a continuous battery symbol only will be shown in the display and the unit will remain OFF.



How to replace the batteries

Remove battery compartment

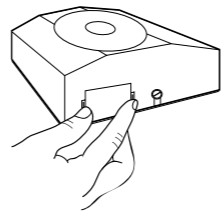

Remove the battery compartment by pinching the tabs and withdrawing downwards. Replace the spent batteries with 2 x AA 1.5V alkaline batteries ensuring correct orientation. Replace the battery compartment pressing fully home.

RF PRODUCT ONLY

SCR RECEIVER (RF Model only)

SCR (Receiver) Normal Operating Mode

- Once the 'Wireless System' has been commissioned, there should be little need for any user interaction with the SCR.
- During normal operation the red and green LEDs will occasionally be on, these signify the following:

Green LED

The green LED will be on when there is a demand for heating, and off when there is no demand.

Red LED

The red LED will flash for 7 seconds, approximately every 5 minutes. This denotes that a radio signal is being received from the Digistat+RF unit.

Situations Requiring Attention

Red LED continually flashing

- This denotes that the batteries in the Digistat+RF unit are approaching the end of their life (see 'battery replacement').

Red LED continually on

- This denotes that the SCR has been unable to receive a radio signal from the Digistat+RF unit. This may be caused by the batteries being dead (see 'battery replacement') or some temporary interference with the radio signal.
- To resend and test the signal, go to the Digistat+RF unit and open the battery drawer, after a few seconds (the display will go blank) close the battery drawer and then reset to your desired temperature. If the radio signal has been successfully transmitted and received, the red LED will flash for 7 seconds then go off.
- If the red LED stays on, there may be some other fault that will require the attention of a heating engineer/electrician.

Manual Override

- The heating can be manually switched on and off by using the 'OVERRIDE' button on the SCR in a fault situation, even though the red LED will stay on until a satisfactory signal is reinstated.
- Once the SCR receives a satisfactory signal again, it will automatically reset itself for normal operation.

Drayton

401 Southway Drive
Plymouth
PL6 6QT
United Kingdom

Technical Helpline Tel: 0333 7000 622
Website: www.draytoncontrols.co.uk
Email: customer.care@draytoncontrols.co.uk

FAULT DIAGNOSIS (All Models)

If the display shows E1, the following faults could have occurred

1. Internal temperature sensor has failed.
2. Ambient temperature is outside product operating temperature range.

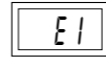

RF PRODUCT ONLY

INSTALLATION OF SCR (RF Models only)

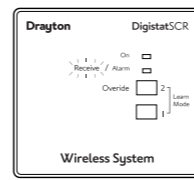

If you do not have the knowledge to install the SCR safely then you must arrange for a competent electrician to install it for you. Wiring must conform to the current IEE regulations.

Prior to commencing the installation you must ensure the mains supply is switched off.

Installation Instructions

Read all installation and commissioning instructions before proceeding.

Do not switch on until ready to commission.

The system wiring must be able to be fully disconnected from the mains supply by a switch incorporated in the fixed wiring having a contact separation of at least 3mm on both poles. Fused at 3A.

Location

The Digistat SCR (receiver) should be mounted in a convenient position, close to the combi boiler or central heating system wiring centre. (Care should be taken not to mount the SCR in a position where it is surrounded by metal objects or mains voltage cable, as this may interfere with the radio signal).

For the best performance install in an open space, at least 30cm distance from any metal objects including wall boxes and boiler housing.

It is recommended that the SCR is mounted on the wall nearest the final location of the Digistat +RF room thermostat and not less than 30cm from the boiler side panel.

Warning: Installing the SCR too close to the metal side panel or mains cables may interfere with the radio signal.

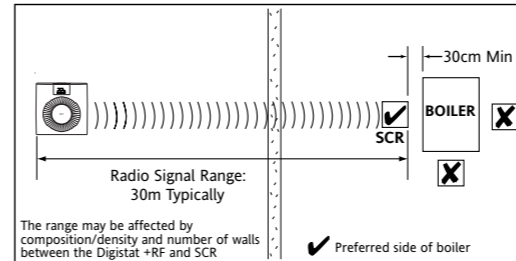

Fixing (minimum wall plate clearances shown)

1. Loosen the securing screws, remove the wallplate, and if surface wiring is to be used, snap out the cable entry strip on the bottom edge of the wallplate with a pair of pliers.
2. Fix the wallplate, terminals at the top, either direct onto the flat wall using wall plugs and no 6 x 1" wood screws or on a flush mounting single conduit box using M3.5 x 14 screws. Minimum wallplate clearances are shown.
3. Complete the wiring to the SCR wallplate in accordance with the relevant diagram, to comply with current IEE regulations.
4. Place the SCR onto the wallplate and tighten the securing screws.

SCR wallplate clearances

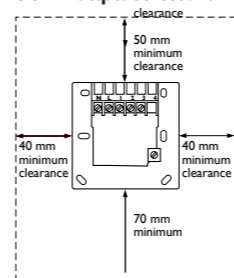

Electrical

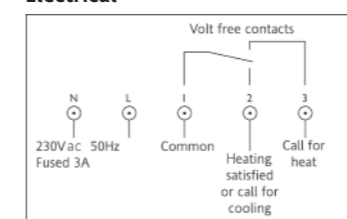

This product is double insulated and does not require an earth connection. The SCR should be wired to the combi boiler or central heating wiring using the correct type of cable or flex. The SCR should be wired in to replace hard wired room or programmable thermostats shown on the system or boiler wiring diagrams. Always check other manufacturers instructions for compatibility.

Combi boiler basic wiring layout

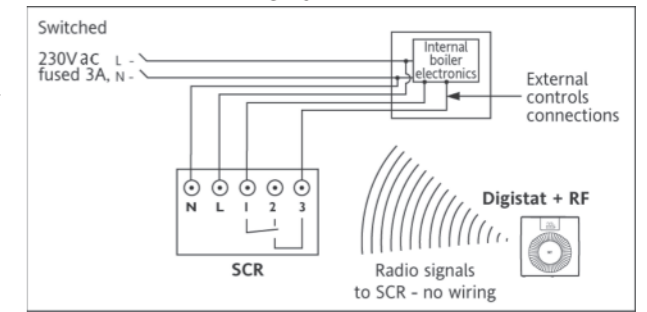

Zone control basic wiring layout

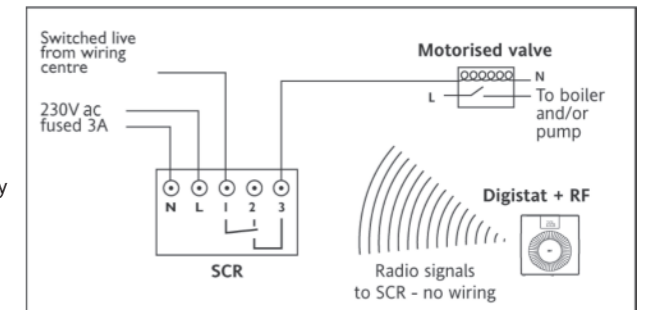

COMMISSIONING THE 'WIRELESS SYSTEM' (RF Models only)

Standard for all models

IMPORTANT: MULTIZONE INSTALLATIONS ONLY
If more than one 'wireless system' is fitted within the same property, ie. for controlling 2 or more zones (multi-zone) it is essential that the Digistat RF units are matched correctly to the relevant SCR. This is easily achieved by commissioning each Digistat and SCR in turn.

1. Install (see installation instructions) and turn power on to the SCR (receiver). If a separate programmer is fitted, ensure that it is switched on. The red LED should come on.
2. Push the 'override' button on the SCR once. The green LED should also come on. Check to see if the boiler and/or motorised valve are working.
3. To enter 'learn' mode push the button marked 1 followed by 2 (OVERRIDE) and hold both depressed together. The red LED should flash for 2 seconds and then go out signifying the SCR is in learn mode. Release both buttons.
4. The red and green LED's should both now be on.
5. Take the Digistat RF and hold it within sight of the SCR (no closer than one metre).
6. Insert the batteries into the holder and slide them into the Digistat RF until the drawer clicks into place.
7. The Digistat RF should now display the actual room temperature. If the unit has been stored in a cold place, it may take time to warm up.
8. As soon as the battery compartment is slid back into place, the red LED on the SCR should flash for 7 seconds and then go out. The green LED may be on or off depending on the room temperature at the time of commissioning.
9. If the red LED remains on, slide down the battery drawer on the Digistat RF, check the battery positions are correct, and once the display has faded, repeat steps 6 to 8.
10. Increase the 'SET' temperature on the Digistat RF by rotating the dial clockwise until a flame symbol appears, in the left hand segment of the display.
11. The red LED on the SCR should flash for 7 seconds. This confirms that the radio signal is being sent and received. After 7 seconds the red LED should go out and the green one come on.
12. Check to confirm that the boiler and/or motorised valves are working.
13. Decrease the 'SET' temperature on the Digistat RF by rotating the dial anticlockwise until the flame symbol disappears.
14. The red LED on the SCR should flash for 7 seconds. After 7 seconds both the red and green LEDs should go out. Check that the boiler and/or motorised valve have powered down.
15. Place the Digistat RF in the chosen operating position. (see Digistat RF location section) and repeat steps 10 to 14. Once you have confirmed the system operates correctly, fit and secure the Digistat RF to the wall (see installation instructions).

During normal operation the red LED on the SCR will flash for 7 seconds each time a radio signal is received from the Digistat RF. This will occur approximately every 5 minutes.

The green LED on the SCR denotes a call for heat (ON).

Once the system has been successfully commissioned, buttons 1 and 2 on the SCR should not be pressed simultaneously, unless a replacement Digistat RF or SCR is fitted.